

# LISTINO 2018

PRICE LIST  
OPERATIVI / OPERATIVE



# INDICE GENERALE

## General Index



### OXI

[Maggiorazioni per tagli a misura (riduzioni dimensionali)]  
Price increase for cuts to size (sizes reduction)

### 5<sup>TH</sup> ELEMENT

### UP

### LOGIC

### CONTENITORI UNIVERSALI EVO

Universal cabinets EVO

[Maggiorazioni per tagli a misura (riduzioni dimensionali)]  
Price increase for cuts to size (sizes reduction)

### POINT Reception

### NICE Reception

### LOUNGE & MEETING TABLES

### OYO- TAVOLI RIBALTABILI/PIEGHEVOLI

OYO- Tilting/folding tables

### OYO- PANNELLI FONODINAMICI®

OYO- Sound-dynamic panels®

### OYO- ACCESSORI

OYO- Accessories

### CONDIZIONI GENERALI DI VENDITA

General sales conditions

### GARANZIA

Warranty card

## LISTINO 2018 PRICE LIST

In vigore dal:  
Valid from:  
01/01/2018

**OPERATIVI / OPERATIVE**

Valido fino a nuova emissione  
Valid until new emission



**La LAS MOBILI s.r.l. è certificata:**

**UNI EN ISO 9001:2008 Attività EA: 23-29 - Certificato n°: SQ153914-ICILA, Certificato IQNET: IT-4695**

Progettazione, produzione ed installazione di pareti interne mobili, arredi per ufficio e sedute.  
Commercializzazione ed installazione di pareti interne mobili, sedute e accessori per ufficio.

*UNI EN ISO 9001:2008 Activity EA: 23-29 - Certificate no: SQ153914-ICILA, Registration Number IQNET: IT-4695  
Design, manufacturing and laying of internal partitions, office furniture and office chairs.  
Trading and laying of internal partitions, office chairs and fittings.*

**UNI EN ISO 14001:2015 Attività EA: 23 - Certificato n°: ICILA-SGA-17258, Certificato IQNET: IT-75470**

Progettazione, carico, stoccaggio, spedizione e consegna di mobili e arredi per ufficio.  
Commercializzazione di sedie e accessori per ufficio.

*UNI EN ISO 14001:2015 Activity EA: 23 - Certificate no: ICILA-SGA-17258, Registration Number IQNET: IT-75470  
Design, loading, stocking, shipping and delivery of office furniture.  
Trading of office chairs and fittings.*

**BS OHSAS 18001:2007 Attività EA: 23e - Certificato n°: ICILA-SCR-000013, Certificato IQNET: IT-54105**

Progettazione e produzione di pareti interne mobili e divisorie, mobili e sedute per ufficio  
(sezionatura, squadratura, bordatura, foratura, pantografatura, incollaggio a caldo, premontaggio,  
imballaggio, movimentazione, confezionamento accessori, stoccaggio e spedizione)

*BS OHSAS 18001:2007 - Activity EA: 23e - Certificate no: ICILA-SCR-000013, Registration Number IQNET: IT-54105  
Design and manufacturing of internal partitions and equipped walls, office furniture and office chairs  
(sectioning, squaring, edging, drilling, pantographs, heat gluing, pre-assembling, packaging,  
mobilisation, accessories packing, stockaging and sending)*



**CERTIFICATO DI ECCELLENZA - CODICE ICILA: LasExc014A/07**

Progettazione, produzione ed installazione di pareti interne mobili, arredi per ufficio e sedute.  
Commercializzazione ed installazione di pareti interne mobili, sedute e accessori per ufficio.

*CERTIFICATE OF EXCELLENCE - ICILA CODE: LasExc014A/07  
Design, manufacturing and laying of internal partitions, office furniture and office chairs.  
Trading and laying of internal partitions, office chairs and fittings.*



**FSC-STD-40-004 VERSION 2.1 Codice registrazione certificato: ICILA-COC-000170**

Acquisto di pannelli truciolari FSC Riciclato e MDF FSC Misto.  
Produzione e vendita di arredi e partizioni mobili per ufficio FSC Misto.

*FSC-STD-40-004 VERSION 2.1 Certification registration code: ICILA-COC-000170  
Purchase of chipboard FSC Recycled and MDF FSC Mixed.  
Production and sale of furniture and partition systems for office FSC Mixed*



**NETWORK LAVORO ETICO SA8000:2008 - Certificato n°144**

Progettazione, produzione ed installazione di pareti interne mobili, arredi per ufficio e sedute.  
Commercializzazione ed installazione di pareti interne mobili, sedute e accessori per ufficio.

*NETWORK LAVORO ETICO SA8000:2008 - Certificate n°144  
Design, manufacturing and laying of internal partitions, office furniture and office chairs.  
Trading and laying of internal partitions, office chairs and fittings.*



**COSMOB QUALITAS PRAEMIUM - FORMALDEIDE - Certificato 04/16**

LAS MOBILI utilizza, nella fabbricazione dei propri prodotti, pannelli a basso contenuto di formaldeide

*COSMOB QUALITAS PRAEMIUM - FORMALDEIDE - Certificate 04/16  
In production LAS MOBILI uses the panels with low contents of formaldehyde*

La produzione **LAS MOBILI**

contribuisce alla salvaguardia dell'ambiente ed alla CERTIFICAZIONE LEED del progetto tramite l'utilizzo di materiali riciclati, la riciclabilità del prodotto e le basse emissioni di VOC.

*The production LAS MOBILI*

*contributes to safeguards the environment and LEED CERTIFICATION of the project thanks to the use of recycled materials, recyclability of the product and low emissions of VOC.*



COSMOB è Socio Ordinario del Green Building Council Italia







MODULO<sup>®</sup>

las group



Il sistema Statunitense di classificazione dell'efficienza energetica e dell'impronta ecologica degli edifici LEED  
 (Leadership in Energy and Environmental Design), sviluppato da : USGBC (U.S. Green Building Council) , fornisce un insieme di standard di misura per valutare le costruzioni ambientalmente sostenibili.  
 U.S. classification system of energetic efficiency and ecological imprint of the buildings LEED  
 (Leadership in Energy and Environmental Design) developed by USGBC (U.S. Green Building Council) provides for a set of standard measurements to evaluate environmentally sustainable buildings.

CONTRIBUTI IN PUNTI LEED DEI PRODOTTI LAS e MODULO	
contribution in LEED points for LAS and MODULO products	
DESCRIZIONI / descriptions	PUNTI /points
<p><b>MR C2 : Gestione dei rifiuti da costruzione</b> <i>Handling of construction garbage</i></p> 	<p><b>2 punti /points</b></p> <hr/>
<p><b>MR C4 : Contenuto di riciclato</b> <i>Contents of recycled</i></p> 	<p><b>2 punti /points</b></p> <hr/>
<p><b>MR C5 : Materiali regionali (commercial interior)</b> <i>Regional materials (commercial interior)</i></p> 	<p><b>1 punto /point</b></p> <hr/>
<p><b>EQ C4.5 : Materiale a basse emissioni</b> <i>Material with low emissions</i></p> 	<p><b>1 punto /point</b></p> <hr/>
<p><b>TOTALE PUNTI PRODOTTI LAS E MODULO :</b> <i>Total points for LAS and MODULO products:</i></p>	<p><b>6 punti /points</b></p>

# CARTELLA COLORI GENERALE

## GENERAL COLOURS SAMPLES CARD

○ = MELAMINICO | MELAMINE  
 △ = 3D-FOIL

### LEGNI | WOOD



**COD. 00**  
**ALLUMINIO MILLERIGHE** | ALUMINIUM STRIPED EFFECT  
 Enosi Evo



**COD. 01**  
**ARGENTO GOLF** | GOLF SILVER  
 Oxi - 5<sup>th</sup> Element - Up - Contenitori Universali Evo  
 - Nice - Oyo



**COD. 03**  
**ROVERE** | OAK  
 Oxi - 5<sup>th</sup> Element - Up - Logic - Contenitori Universali  
 Evo - Point - Oyo- Delta Evo



**COD. 04**  
**ROVERE GREY** | GREY OAK  
 5<sup>th</sup> Element - Up - Contenitori Universali Evo - Point  
 - Oyo- Delta Evo



**COD. 06**  
**NOCE PAVIA** | PAVIA WALNUT  
 Oxi - 5<sup>th</sup> Element - Up - Logic - Contenitori Universali  
 Evo - Point - Oyo- Delta Evo



**COD. 08**  
**OLMO** | ELM  
 E.O.S.



**COD. 11**  
**GIALLO FRESIA** | FREESIA YELLOW  
 5<sup>th</sup> Element - Contenitori Universali Evo



**COD. 12**  
**OLMO GREY** | GREY ELM  
 Iulio - Jera - I Meet

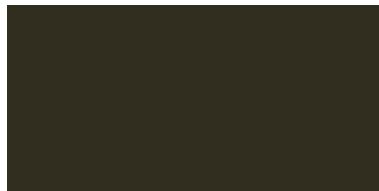

**COD. 14**  
**LAVA** | LAVA  
 Iulio

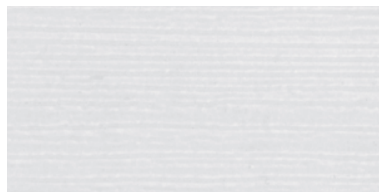

**COD. 15**  
**BIANCO NATUR MAT** | NATUR MAT WHITE  
 Nice - Iulio Hg



**COD. 16**  
**NERO NATUR MAT** | NATUR MAT BLACK  
 Nice - Iulio Hg - Seventies



**COD. 29**  
**NOCE ITALIA** | ITALY WALNUT  
 Nice - Enosi Evo



**COD. 30**  
**NOCE BALI** | BALI WALNUT  
 Iulio - Jera - I Meet



**COD. 32**  
**AZZURRO SKY** | SKY BLUE  
 5<sup>th</sup> Element - Contenitori Universali Evo

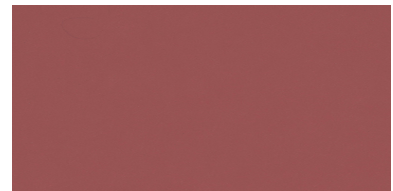

**COD. 33**  
**AMARANTO** | AMARANTH  
 5<sup>th</sup> Element - Contenitori Universali Evo- Delta Evo



**COD. 37**  
**NOCE PACIFIC** | PACIFIC WALNUT  
 Enosi Evo



**COD. 42**  
**GRIGIO** | GREY  
 Oxi - Up - Contenitori Universali Evo - Oyo



**COD. 44**  
**STONE GREY** | STONE GREY  
 Oxi - 5<sup>th</sup> Element - Up - Contenitori Universali Evo  
 - Point - Oyo - Delta Evo - Seventies - Jera - I Meet



**COD. 45** ○ △  
**WENGÉ | WENGÉ**  
 5<sup>th</sup> Element - Up - Contenitori Universali Evo - Point  
 - Oyo - Enosi Evo - I Meet



**COD. 48** △  
**BIANCO HIGH GLOSS | HIGH GLOSS WHITE**  
 Nice - Iulio Hg



**COD. 49** △  
**NERO HIGH GLOSS | HIGH GLOSS BLACK**  
 Nice - Iulio Hg



**COD. 50** △  
**ZEBRANO HIGH GLOSS | HIGH GLOSS ZEBRAWOOD**  
 Nice



**COD. 52** △  
**FRASSINO BROWN | BROWN ASH**  
 Iulio - Jera - I Meet



**COD. 55** ○  
**ANTRACITE | ANTHRACITE**  
 5<sup>th</sup> Element - Contenitori Universali Evo - Point - Oyo  
 - Delta Evo - Iulio - Iulio Hg - E.O.S. - Jera - I Meet



**COD. 58** ○  
**ACERO TAKI | TAKI MAPLE**  
 5<sup>th</sup> Element - Up - Contenitori Universali Evo Oyo



**COD. 61** △  
**ROVERE AFRO | AFRICAN OAK**  
 Enosi Evo - I Meet



**COD. 62** ○  
**ROVERE DARK | DARK OAK**  
 E.O.S.



**COD. 67** △  
**TEAK SAMOA | SAMOA TEAK**  
 Iulio - I Meet

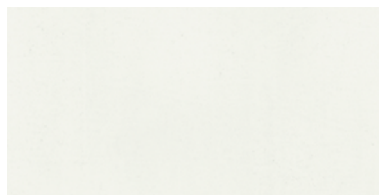

**COD. 69** ○ △  
**BIANCO BR. | BR. WHITE**  
 Oxi - 5<sup>th</sup> Element - Up - Logic - Contenitori Universali  
 Evo - Point - Nice - Oyo - Delta Evo - Iulio - Iulio Hg  
 - Enosi Evo - Seventies - I Meet

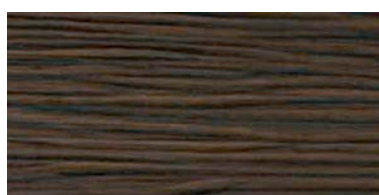

**COD. 70** ○  
**CACAO | CACAO**  
 E.O.S.



**COD. 85** △  
**LARICE SABBIA | SAND LARCH**  
 Nice - I Meet



**COD. 86** △  
**LARICE MOKA | MOKA LARCH**  
 Nice - I Meet



**COD. 91** △  
**ACERO | MAPLE**  
 Enosi Evo

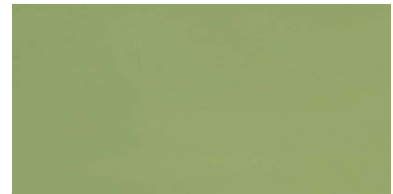

**COD. 96** ○  
**VERDE BOSCO | WOOD GREEN**  
 5<sup>th</sup> Element - Contenitori Universali Evo

## VETRI | GLASS



**COD. 10**

**NERO | BLACK**

5<sup>th</sup> Element - Nice - Iulio Hg - Enosi Evo - Seventies  
| Meet



**COD. 75**

**PISTACCHIO | PISTACHIO**

E.O.S. - Enosi Evo - I Meet



**COD. 99**

**BIANCO SATINATO | SATINED WHITE**

Contenitori Universali Evo- Nice - Delta Evo - Iulio  
- E.O.S.



**COD. 72**

**TORTORA | GREY BEIGE**

Oxi - 5<sup>th</sup> Element - Iulio - E.O.S. - Seventies - I Meet



**COD. 78**

**BIANCO EXTRA | EXTRA WHITE**

Nice - Iulio Hg - Enosi Evo - Seventies

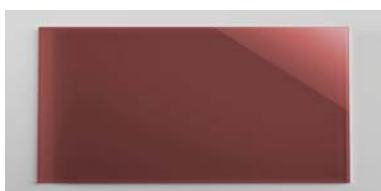

**COD. 74**

**ROSSO RUBINO | RUBY RED**

5<sup>th</sup> Element - E.O.S. - Enosi Evo - I Meet



**COD. 79**

**BIANCO | WHITE**

Oxi - 5<sup>th</sup> Element

## METALLI | METALS



**COD. AN 02**

**ANTRACITE | ANTHRACITE**

5<sup>th</sup> Element - Contenitori Universali Evo - Oyo - I Meet

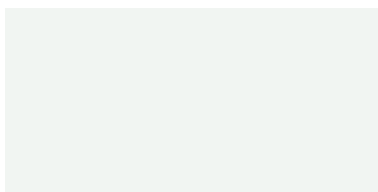

**COD. BI 02**

(RAL 9016)

**BIANCO | WHITE**

Oxi - 5<sup>th</sup> Element - Enosi Evo



**COD. NR 02**

**NERO | BLACK**

Enosi Evo



**COD. AR 02**

**ARGENTO | SILVER**

Oxi - 5<sup>th</sup> Element

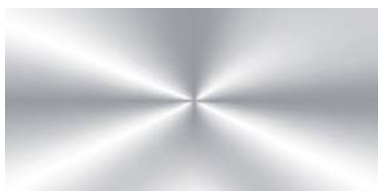

**COD. CR 01**

**CROMATO | CHROMED**

5<sup>th</sup> Element - Enosi Evo - Seventies - I Meet



**COD. SG 01**

**STONE GREY | STONE GREY**

Oxi - 5<sup>th</sup> Element - Contenitori Universali Evo - Oyo - I Meet

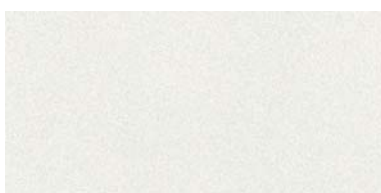

**COD. BI 01**

**BIANCO BR. | BR. WHITE**

Logic



**COD. IG 01**

**INOX GREY | GREY INOX**

Iulio





**LISTINO** 2018  
PRICE LIST

# OXI

Design      Engineering  
STUDIO SI    C.S.R. LAS MOBILI

Conforme al DLGS 81/2008 (già 626/'94)  
apply to RULE 81/2008 (626/'94)

### IMPORTANTE / it's very important

SULL'ORDINE INDICARE SEMPRE IL CODICE COMPLETO A 9 CIFRE  
always indicate on the order the complete 9-digit code

ESEMPIO: PER ORDINARE 1 SCRIVANIA **ART.045** NOCE PAVIA INDICARE IL CODICE =  
example: to order 1 DESK **ART.045** PAVIA WALNUT indicate the code =

**148**    **045**    **166**

DECODIFICA → MODELLO    ARTICOLO    CODICE FINITURA (\*)  
decoding            model            articolo            finish code (\*)



Certificato 04/16

In vigore dal:  
Valid from:  
01/01/2018

Valido fino a nuova emissione  
Valid until new emission

Per eventuali aggiornamenti più recenti  
le **CERTIFICAZIONI** e i **LISTINI** sono disponibili su Internet:  
For latest updatings  
the **CERTIFICATIONS** and **PRICE LIST** are available on Internet:

1-  [www.las.it](http://www.las.it)

2- AREA RISERVATA RIVENDITORE  
Dealer's private area

3- SCARICA DOCUMENTI IN FORMATO .PDF  
Downloads .PDF files



<b>CERTIFICAZIONI DISPONIBILI / available certifications</b>			
<b>MATERIALI E FINITURE / materials and finishes</b>			
	<b>NORMA DI RIFERIMENTO standard norms</b>	<b>DESCRIZIONE NORMA</b>	<b>norm descriptions</b>
<b>ELEMENTI METALLICI / metallic elements</b>	Conformità DM 03/09/2001	Reazione al fuoco. Dichiarazione di conformità al DM 26/06/1984 modificato da DM 03/09/2001.	Reaction to fire. Declaration of conformity to the MD 26/06/1984 modified by MD 03/09/2001.
	UNI EN 12720:1997	Resistenza ai liquidi freddi.	Cold liquids resistance.
	UNI EN 12722:1997	Resistenza al calore secco.	Dry heat resistance.
	UNI EN 13722:2004	Riflessione speculare della superficie	Measurement of specular gloss of the surface.
	UNI EN ISO 12460-3:2015	Rilascio di formaldeide. Gas analisi, prova singola.	Formaldehyde release.
	UNI 10460:1995	Determinazione della resistenza dei bordi all'acqua.	Water resistance of the edges.
	UNI 8941-2:1987	Colorimetria. Determinazione strumentale del colore.	Colourimetry. Test for the determination of the colour.
	UNI 9115:1987	Comportamento delle superfici all'usura per abrasione. Abrasione Taber.	Taber abrasion. Test for abrasion resistance of the surfaces.
	UNI 9240:1987	Determinazione dell'adesione delle finiture al supporto mediante prova di strappo.	Determination of finishes adhesion to the support proved by stripping test.
	UNI 9242:1987 + UNI 9242:1987/A1/98	Determinazione della resistenza dei bordi al calore.	Determination of heat resistance of the edges.
	UNI 9300:1988 + FA 276:1989	Determinazione della tendenza della superficie a ritenere lo sporco.	Test for surfaces tendency to retain dirt.
	UNI EN 15187:2007	Valutazione degli effetti dell'esposizione alla luce.	Evaluation of the effects of the exposure to the light.
	UNI 9428:1989	Prove sulle finiture delle superfici. Determinazione della resistenza alla graffiatura.	Test for scratch resistance of the surfaces.
	UNI 9429:1989	Determinazione della resistenza delle superfici agli sbalzi di temperatura.	Test for thermal endurance of the surfaces.
	UNI EN 12721:2009	Valutazione della resistenza delle superfici al calore umido.	Test for the determination of damp heat resistance.
	ASTM D 3363:2005	Prova di durezza molla e/o matita.	Hardness test to pencil.
	EN ISO 1520:1995	Imbutitura statica.	Static drawing test.
	UNI 8901:1986	Resistenza all'urto.	Impact resistance.
	UNI 9115:1987	Comportamento delle superfici all'usura per abrasione. Abrasione Taber.	Taber abrasion. Test for abrasion resistance of the surfaces.
	UNI 9427:1989	Determinazione della resistenza delle superfici alla luce.	Test for light resistance of the surfaces.
	UNI 9428:1989	Prove sulle finiture delle superfici. Determinazione della resistenza alla graffiatura.	Test for scratch resistance of the surfaces.
UNI 9429:1989	Determinazione della resistenza delle superfici agli sbalzi di temperatura.	Test for thermal endurance .	
UNI EN ISO 2409:1996	Adesione mediante quadrettatura.	Adhesion with checkering.	
UNI EN ISO 2808:2007	Pitture e vernici. Determinazione dello spessore del film.	Paints and varnishes. Determination of the film thickness.	
UNI EN ISO 9227:2006	Prove in nebbia salina.	Test for salt fog resistance.	
<b>SCRIVANIE, WORKSTATION E TAVOLI / desks, workstation and tables</b>			
	<b>NORMA DI RIFERIMENTO standard norms</b>	<b>DESCRIZIONE NORMA</b>	<b>norm descriptions</b>
	Conformità D.LGS. 09/04/2008 nr.81	Dichiarazione di Conformità al D.LGS. 09/04/2008 nr.81 (ex 626).	Declaration of conformity to the italian rule D.LGS. 09/04/2008 nr.81 (ex 626).
	UNI 8594:2004	Prova di flessione dei piani.	Test for flexural strength of the tops.
	UNI 9086:1987	Prova di urto contro le gambe o i fianchi di sostegno.	Impact test against the legs or the support side panels.
	UNI EN 527-1:2000	Dimensioni.	Dimensions.
	UNI EN 527-2:2003 Par. 3	Par. 3 Requisiti meccanici di sicurezza. Requisiti generali di progettazione.	Par. 3 Safety mechanics requirements. General requirements of the engineering
	UNI EN 527-3:2003 Par. 5.1	Par. 5.1 Stabilità.	Par. 5.1 Stability.
	UNI EN 527-3:2003 Par. 5.2	Par. 5.2 Resistenza sotto una forza verticale.	Par. 5.2 Resistance to vertical force.
	UNI EN 527-3:2003 Par. 5.3	Par. 5.3 Resistenza sotto una forza orizzontale.	Par. 5.3 Resistance to horizontal force.
	UNI EN 527-3:2003 Par. 5.4	Par. 5.4 Fatica sotto una forza orizzontale.	Par. 5.4 Endurance limit to horizontal force.
	UNI EN 527-3:2003 Par. 5.5	Par. 5.5 Fatica sotto una forza verticale.	Par. 5.5 Endurance limit to vertical force.
	UNI EN 527-3:2003 Par. 5.6	Par. 5.6 Prova di caduta.	Par. 5.6 Drop test.
<b>MOBILI CONTENITORI / storage furniture</b>			
	<b>NORMA DI RIFERIMENTO standard norms</b>	<b>DESCRIZIONE NORMA</b>	<b>norm descriptions</b>
	UNI 8601:1984	Prova di flessione dei piani.	Test for flexural strength of the shelves.
	UNI 8606:1984	Prova di carico totale massimo.	Maximum load test.
	UNI EN 16122:2012 +EC1 2013	Prova di resistenza del fondo dei cassetti.	Test for strength of bottom of the drawers.
	UNI EN 14073-2:2005 Par. 3.4	Par. 3.4 Requisito generale di sicurezza.	Par. 3.4 General safety requirement.
	UNI EN 14073-3:2005 Par. 5.2	Par. 5.2 Resistenza del mobile.	Par. 5.2 Strength of the cabinet structure.
	UNI EN 14073-3:2005 Par. 5.3.1	Par. 5.3.1 Estrazione dei ripiani.	Par. 5.3.1 Extraction of the shelves.
	UNI EN 14073-3:2005 Par. 5.3.2	Par. 5.3.2 Resistenza dei supporti dei ripiani.	Par. 5.3.2 Strength of the shelves supports.
	UNI EN 14073-3:2005 Par. 5.4	Par. 5.4 Resistenza dei piani di copertura.	Par. 5.4 Strength of the tops.
	UNI EN 14073-3:2005 Par. 5.5	Par. 5.5 Stabilità dei mobili indipendenti.	Par. 5.5 Stability of single cabinet.
	UNI EN 14074:2005 Par. 6.2.1	Par. 6.2.1 Resistenza degli elementi estensibili.	Par. 6.2.1 Strength of the stretchable elements.
	UNI EN 14074:2005 Par. 6.2.2	Par. 6.2.2 Prova di durabilità degli elementi estensibili.	Par. 6.2.2 Duration of the stretchable elements.
	UNI EN 14074:2005 Par. 6.2.3	Par. 6.2.3 Apertura con urto degli elementi estensibili.	Par. 6.2.3 Opening with crash of the stretchable elements.
	UNI EN 14074:2005 Par. 6.3.1	Par. 6.3.1 Carico verticale sulle porte.	Par. 6.3.1 Load test of pivoted doors.
	UNI EN 14074:2005 Par. 6.3.2	Par. 6.3.2 Forza statica orizzontale sulla porta aperta.	Par. 6.3.2 Horizontal static force on open door.
	UNI EN 14074:2005 Par. 6.3.3	Par. 6.3.3 Prova di durabilità delle porte con cerniera e ad asse verticale.	Par. 6.3.3 Duration of the doors with hinge and vertical axle.
	UNI EN 14074:2005 Par. 6.7	Par. 6.7 Prova di rotolamento per cassettiere su ruote.	Par. 6.7 Rolling test for pedestals on wheels.

	<b>CARTELLA COLORI</b> .....	<b>6</b>
	<i>colours samples card</i>	
	<b>ABBINAMENTI COLORI</b> .....	<b>7</b>
	<i>matching colours</i>	
	<b>TIPOLOGIE SCRIVANIE</b> .....	<b>8</b>
	<i>typology desks</i>	
	<b>DIMENSIONI SCRIVANIE</b> .....	<b>9</b>
	<i>dimensions of desks</i>	
<b>OXI BASIC</b>	<b>SCRIVANIE BASAMENTO LEGNO</b> .....	<b>11</b>
	<i>desks with panels base</i>	
	<b>SCRIVANIE CON GAMBE METALLICHE A "T" SAGOMATE E TRAVE FISSA CANALIZZATA</b> .....	<b>12</b>
	<i>desks with "T" shaped metal legs and fixed cable-way beam</i>	
	<b>SCRIVANIE CON GAMBE A PONTE</b> .....	<b>13</b>
	<i>desks with bridge legs</i>	
	<b>WORKSTATION CON GAMBE A PONTE</b> .....	<b>14</b>
	<i>workstation with bridge legs</i>	
	<b>BENCH PROF.125,2 CON GAMBE A PONTE</b> .....	<b>15</b>
	<i>bench depth 125,2 cms with bridge legs</i>	
	<b>BENCH PROF.165,2 CON GAMBE A PONTE</b> .....	<b>15</b>
	<i>bench depth 165,2 cms with bridge legs</i>	
	<b>SOSTEGNI SOTTOPIANO PER SCRIVANIE</b> .....	<b>17</b>
	<i>undertop stirrups for desks</i>	
	<b>SCRIVANIE CON GAMBE METALLICHE A "T" QUADRATE E TRAVE FISSA CANALIZZATA</b> .....	<b>19</b>
	<i>desks with "T" squared metal legs and fixed cable-way beam</i>	
<b>OXI TREND</b>	<b>SCRIVANIE CON GAMBE A PONTE TRAPEZOIDALI</b> .....	<b>20</b>
	<i>desks with trapezoid bridge legs</i>	
	<b>WORKSTATION CON GAMBE A PONTE TRAPEZOIDALI</b> .....	<b>21</b>
	<i>workstation with trapezoid bridge legs</i>	
	<b>BENCH PROF. CM 165,2 CON TOP ACCESS A RIBALTA</b> .....	<b>22</b>
	<i>bench depth 165,2 cms with top access tip-up door</i>	
	<b>COMBY MONO-FACCIALI</b> .....	<b>23</b>
	<i>single-side COMBY</i>	
	<b>COMBY BI-FACCIALI</b> .....	<b>23</b>
	<i>double-side COMBY</i>	
	<b>CANALINE PER COMBY</b> .....	<b>24</b>
	<i>cable tray for comby</i>	
	<b>LIBRERIE PER ESTENSIONE COMBY</b> .....	<b>24</b>
	<i>bookcases for extension comby</i>	
	<b>STAFFE PER SCRIVANIE PROF. CM 60 SU COMBY</b> .....	<b>25</b>
	<i>fixing stirrups for desks depth 60 cms on comby</i>	
	<b>SCRIVANIE PER COMBY</b> .....	<b>26</b>
	<i>desks for COMBY</i>	
	<b>BENCH PROF. CM 125,2 PER COMBY</b> .....	<b>28</b>
	<i>bench depth 125,2 cms for COMBY</i>	
	<b>BENCH PROF. CM 165,2 PER COMBY</b> .....	<b>28</b>
	<i>bench depth 165,2 cms for COMBY</i>	
	<b>SOSTEGNI SOTTOPIANO PER SCRIVANIE</b> .....	<b>30</b>
	<i>undertop stirrups for desks</i>	

**N.B.: CASSETTIERE SU RUOTE, ALTRE TIPOLOGIE DI MOBILI CONTENITORI  
E LIBRERIE A SPALLA UNICA**

**SONO INSERITI NEL CAPITOLO "CONTENITORI UNIVERSALI EVO"**

**PLEASE NOTE: you can find pedestal on wheels, other cabinet models  
and bookcases with shared side panel in the section "UNIVERSAL CABINETS EVO"**

<b>ELEMENTI COMUNI</b> shared elements	<b>CASSETTIERE-BASI O LATERALI PER SCRIVANIE</b> .....	<b>32</b>
	<i>base or lateral pedestals for desks</i>	
	<b>STAFFA PER CASSETTIERA-BASE</b> .....	<b>33</b>
	<i>stirrup for base pedestals</i>	
	<b>MOBILI LATERALI PER SCRIVANIE E WORKSTATION PROF. CM 60</b> .....	<b>34</b>
	<i>side cabinets for desks and workstation depth 60 cms</i>	
	<b>MOBILI LATERALI PER SCRIVANIE E WORKSTATION PROF. CM 80</b> .....	<b>35</b>
	<i>side cabinets for desks and workstation depth 80 cms</i>	
	<b>PANNELLI FRONTALI PER BENCH</b> .....	<b>36</b>
	<i>front panels for bench</i>	
	<b>PANNELLI FRONTALI PER SCRIVANIE</b> .....	<b>37</b>
	<i>front panels for desks</i>	
	<b>KIT RIVESTIMENTO PER PANNELLI FRONTALI SCRIVANIE</b> .....	<b>37</b>
	<i>upholstered sound-proofing cover kit for front panel for desks</i>	
	<b>SCHIENE PER SCRIVANIE CON BASAMENTI METALLICI</b> .....	<b>39</b>
	<i>modesty panels for desks with metal base</i>	
	<b>PIANI SCRIVANIE PROF. CM 60</b> .....	<b>40</b>
	<i>desk tops depth 60 cms</i>	
	<b>PIANI SCRIVANIE PROF. CM 80 E WORKSTATION</b> .....	<b>41</b>
	<i>desk tops depth 80 cms and workstation</i>	
	<b>ESTENSIONI CON VENATURA TRASVERSALE</b> .....	<b>41</b>
	<i>extensions with transversal wood veining</i>	
	<b>PENISOLA E ANGOLO DI RACCORDO</b> .....	<b>42</b>
	<i>terminal and joining segment</i>	
	<b>KIT ELETTTRIFICAZIONE tipo K1 (BACHMANN)</b> .....	<b>43</b>
	<i>electrification kit type K1 (by Bachmann)</i>	
	<b>KIT ELETTTRIFICAZIONE tipo K2 (BACHMANN)</b> .....	<b>43</b>
	<i>electrification kit type K2 (by Bachmann)</i>	
	<b>MODULI PERSONALIZZABILI (BACHMANN)</b> .....	<b>43</b>
	<i>customizable modules (by Bachmann)</i>	
	<b>KIT ELETTTRIFICAZIONE TIPO Y3</b> .....	<b>44</b>
	<i>electrification kit type Y3</i>	
	<b>SCHEMA DI UTILIZZO KIT ELETTTRIFICAZIONE</b> .....	<b>44</b>
	<i>scheme of use electrification kit</i>	
	<b>PARETINE MONO-PANNELLO H.109,3</b> .....	<b>47</b>
	<i>single element panels H.109,3 cms</i>	
	<b>PARETINE MONO-PANNELLO H.135</b> .....	<b>47</b>
	<i>single element panels H.135 cms</i>	
	<b>PARETINE MONO-PANNELLO H.160</b> .....	<b>48</b>
	<i>single element panels H.160 cms</i>	
	<b>MONTANTI RACCORDO PER PARETINE</b> .....	<b>48</b>
	<i>uprights for panel system</i>	
	<b>PROFILO TERMINALE PER PARETINA (OPTIONAL)</b> .....	<b>49</b>
	<i>terminal profile for partition panel (OPTIONAL)</i>	
	<b>VASCHETTE PASSACAVI PER PARETINA</b> .....	<b>49</b>
	<i>cable-trays for partition panel</i>	
	<b>SOSTEGNI PER PIANI INTEGRABILI SU PARETINE</b> .....	<b>50</b>
	<i>supports for tops connectable to partitions</i>	
	<b>ACCESSORI PER PARETINE</b> .....	<b>51</b>
	<i>accessories for partition panels</i>	
	<b>TAVOLO DA SALOTTO</b> .....	<b>53</b>
	<i>coffee table</i>	
	<b>TAVOLI RIUNIONE BASAMENTO LEGNO</b> .....	<b>53</b>
	<i>meeting table with panel base</i>	
	<b>TAVOLI RIUNIONE BASAMENTO METALLICO</b> .....	<b>54</b>
	<i>meeting table with metal base</i>	
	<b>DESCRIZIONE TECNICA</b> .....	<b>56</b>
	<b>TECHNICAL DESCRIPTIONS</b> .....	<b>59</b>
	<b>INDICE DEI CODICI</b> .....	<b>62</b>
	<i>codes index</i>	

**CARTELLA COLORI**  
colours samples card



**COD. 01**  
ARGENTO GOLF | GOLF SILVER



**COD. 06**  
NOCE PAVIA | PAVIA WALNUT



**COD. 44**  
STONE GREY | STONE GREY



**COD. 03**  
ROVERE | OAK



**COD. 42**  
GRIGIO | GREY

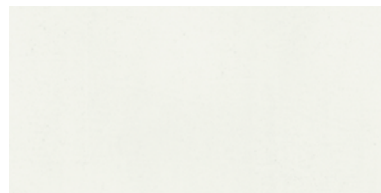

**COD. 69**  
BIANCO BR. | BR. WHITE

**STRUTTURE METALLICHE PER OXI TREND**  
OXI TREND METALLIC STRUCTURES

**STRUTTURE METALLICHE PER OXI BASIC**  
OXI BASIC METALLIC STRUCTURES



**COD. AR 02**  
ARGENTO | SILVER

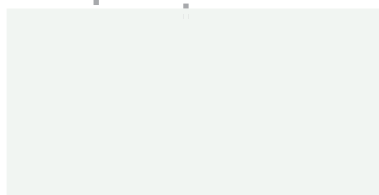

**COD. BI 02** (RAL 9016)  
BIANCO | WHITE



**COD. SG 01**  
STONE GREY | STONE GREY

**PIANI VETRO**  
GLASS DESKTOP



**COD. 72**  
TORTORA | GREY BEIGE



**COD. 79**  
BIANCO | WHITE

**TESSUTI PER PANNELLI FONO-ASSORBENTI**  
FABRICS FOR SOUND-PROOFING PANELS

**Cat. F**



**POLIESTERE STRETCH IGNIFUGO**  
100% poliestere FR riciclato  
Martindale 50.000

**FIRE-RETARDANT STRETCH POLYESTER**  
100% polyester FR recycled  
Martindale 50.000

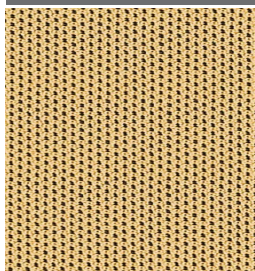

**321**  
GIALLO FRESIA | FREESIA  
YELLOW



**320**  
AZZURRO SKY | SKY BLUE



**322**  
AMARANTO | AMARANTH



**323**  
VERDE BOSCO | WOOD GREEN



**328**  
TORTORA | GREY BEIGE

ABBINAMENTI COLORI matching colours  OXI		COLORI LEGNI wooden colours					COLORI VETRI glass colours		TESSUTO POLIESTERE STRETCH IGNIFUGO fire-retardant stretch polyester fabric					COLORI METALLI metal colours			
		ROVERE oak	NOCE PAVIA pavia walnut	GRIGIO grey	STONE GREY stone grey	BIANCO BR. br. white	ARGENTO GOLF golf silver	TORTORA grey beige	BIANCO white	AZZURRO SKY sky blue	GIALLO FRESIA freesia yellow	AMARANTO amaranth	VERDE BOSCO wood green	TORTORA grey beige	ARGENTO silver	BIANCO white	STONE GREY stone grey
COMPONENTI components		Cod. 03	Cod. 06	Cod. 42	Cod. 44	Cod. 69	Cod. 01	Cod. 72	Cod. 79	Cod. 320	Cod. 321	Cod. 322	Cod. 323	Cod. 328	AR 02	BI 02	SG 01
<b>OXI BASIC</b> SCRIVANIE, TAVOLO DA SALOTTO, TAVOLI RIUNIONE desks, coffee table, meeting tables	PIANO desktop	◇	◇	◇	◇	◇											
	FIANCHI LEGNO E SCHIENA side panels and back panel				◇	◇	◇										
<b>OXI BASIC</b> SCRIVANIE, BENCH E TAVOLI RIUNIONE CON STRUTTURA METALLICA desks, bench and meeting table with metal structure	PIANO desktop	◇	◇	◇	◇	◇											
	TRAVI beam														◇	◇	
	GAMBE legs														◇	◇	
<b>OXI TREND</b> BENCH FIANCHI LEGNO desks and coffee table	PIANO desktop	◇	◇		◇	◇											
	FIANCHI LEGNO E SCHIENA side panels and back panel				◇	◇											
<b>OXI TREND</b> SCRIVANIE CON STRUTTURA METALLICA desks with metal structure	PIANO desktop	◇	◇		◇	◇		◇	◇								
	TRAVI beam														◇	◇	◇
	GAMBE legs														◇	◇	◇
<b>OXI TREND</b> COMBY	PIANO desktop	◇	◇		◇	◇											
	STRUTTURA structure				◇	◇											
MODESTY PANEL	PANNELLO panel				◇	◇	◇										
	STAFFE stirrups														◇	◇	◇
VASCHEE PASSACAVI cable trays															◇	◇	◇
MOBILI PER SCRIVANIE CASSETTIERE-BASI base-pedestals undertop cabinet	TOP top	◇	◇	◇	◇	◇											
	FRONTALI fronts panel	◇	◇	◇	◇	◇											
	STRUTTURA structure				◇	◇	◇										
PANNELLI FRONTALI front panels	PANNELLO panel				◇	◇	◇										
	SUPPORTI supports														◇	◇	◇
PARETINE partition panels					◇	◇	◇										
PANNELLI FONOASSORBENTI sound-absorbing panels										◇	◇	◇	◇	◇			
ACCESSORI accessories															◇	◇	◇

**TIPOLOGIE SCRIVANIE**  
typology desks

**OXI\_BASIC**

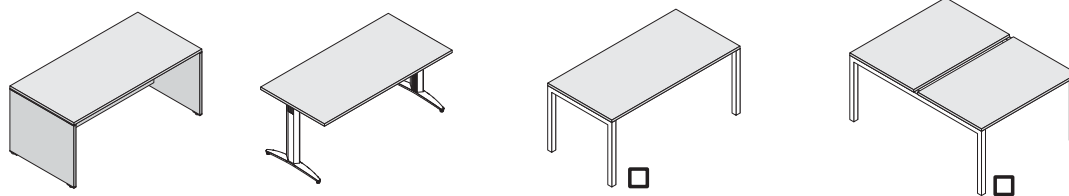

**OXI\_TREND**

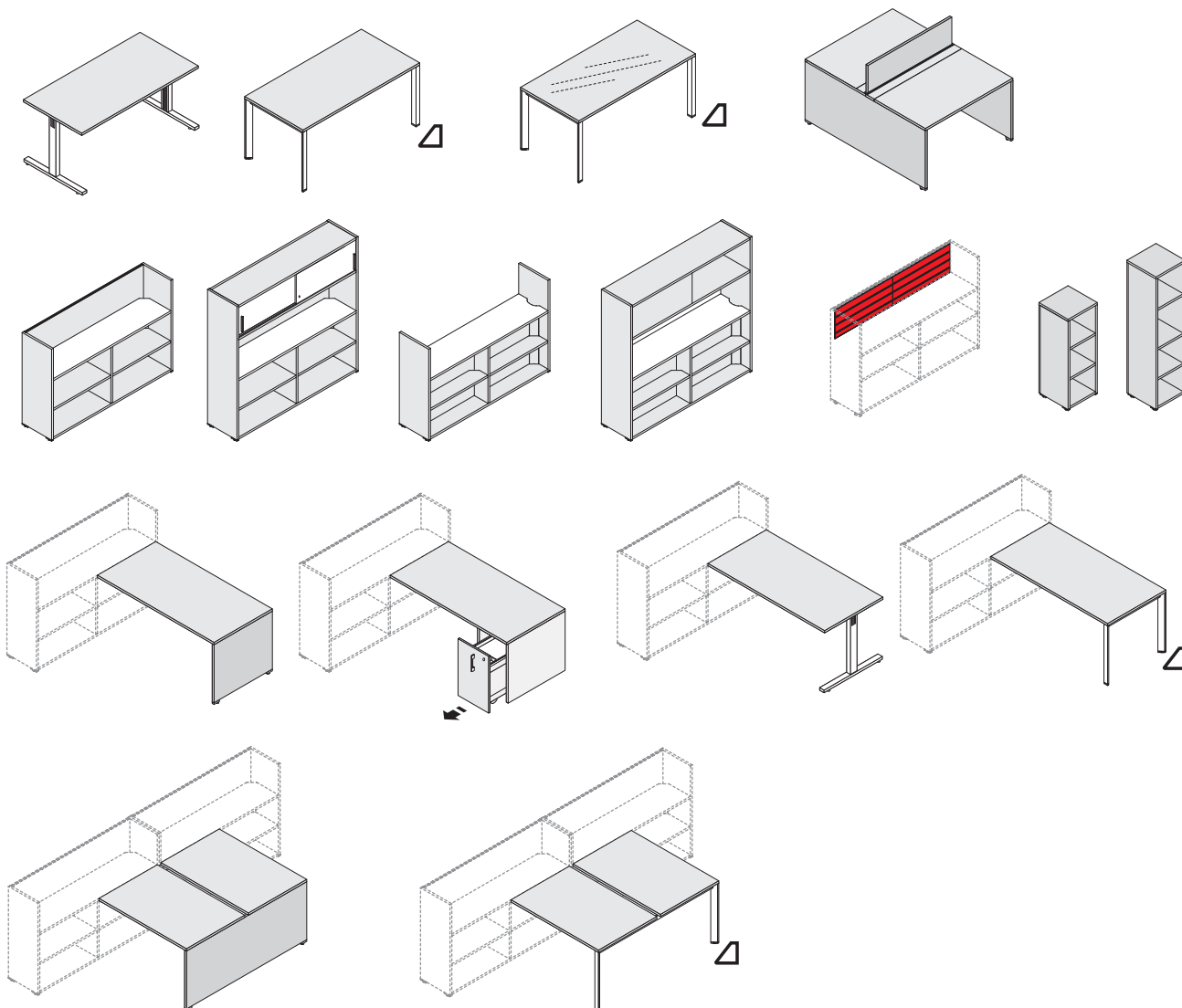

**ELEMENTI COMUNI**\_shared elements

- |                                       |                                    |
|---------------------------------------|------------------------------------|
| - CASSETTIERE E MOBILI PER SCRIVANIE  | - pedestals and cabinets for desks |
| - PANNELLI FRONTALI E ACCESSORI       | - front panel and accessories      |
| - MODESTY PANELS                      | - modesty panels                   |
| - PIANI SCRIVANIE E WORKSTATION       | - desk tops and workstation tops   |
| - PENISOLA E ANGOLO DI RACCORDO       | - terminal and joinin segment      |
| - PANNELLI PARETINA e ACCESSORI       | - partition panels and accessories |
| - SOSTEGNI PER PARETINA               | - supports for partition panels    |
| - TAVOLI DA SALOTTO E TAVOLI RIUNIONE | - coffee tables and meeting tables |



**DIMENSIONI SCRIVANIE**  
*dimensions of desks*

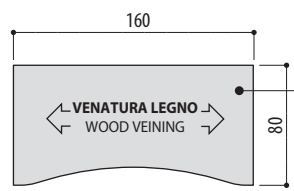
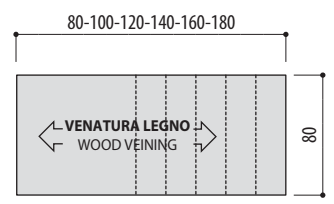
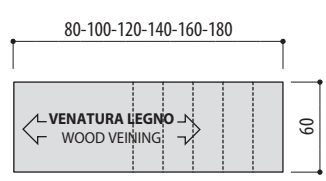

- ART. 063
- ART. 094
- ART. 122
- ART. 123
- ART. 185
- ART. 234
- ART. 327
- ART. 367
- ART. 381
- ART. 549

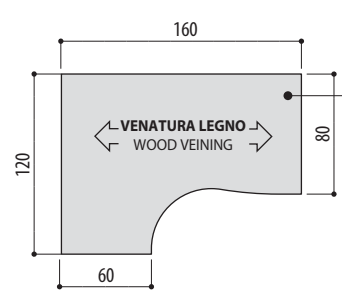
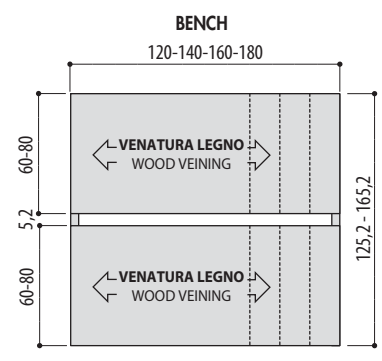

- ART. 067
- ART. 096
- ART. 128
- ART. 187
- ART. 238
- ART. 551

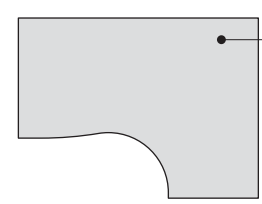

- ART. 066
- ART. 095
- ART. 127
- ART. 186
- ART. 237
- ART. 550

**CON RIDUZIONE A SX**  
 WITH LEFT REDUCTION

**CON RIDUZIONE A DX**  
 WITH RIGHT REDUCTION

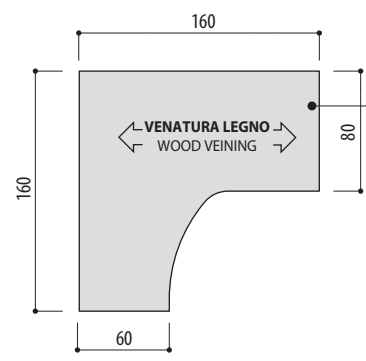

- ART. 098
- ART. 189
- ART. 553

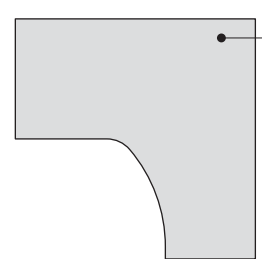

- ART. 097
- ART. 188
- ART. 552

**CON RIDUZIONE A SX**  
 WITH LEFT REDUCTION

**CON RIDUZIONE A DX**  
 WITH RIGHT REDUCTION

**WORKSTATION SIMMETRICA**  
 SYMMETRICAL WORKSTATION

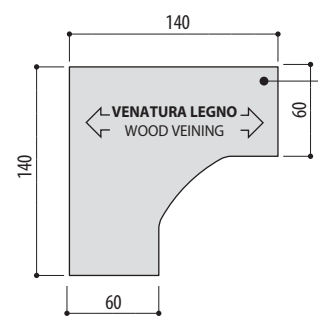

- ART. 068
- ART. 099
- ART. 190
- ART. 554

# OXI\_BASIC

**PIANI sp. 25mm**  
 tops thick. 25mm

**SCRIVANIE BASAMENTO LEGNO**
*desks with panels base*

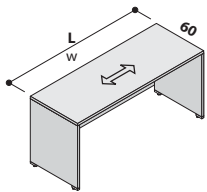
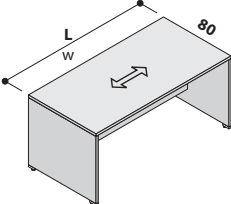
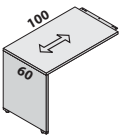
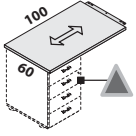
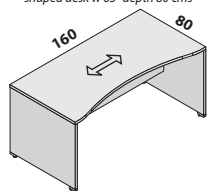
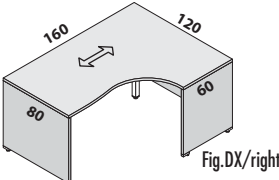
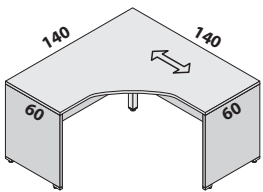
DESCRIZIONE <i>description</i>	L w	CODICE code	KG	M <sup>3</sup>	COLLI	PREZZO price	(*) CODICE FINITURA (*) finish code								
SCRIVANIE PROF. CM 60 <i>desks depth 60 cms</i>  L x p.60 x H.73,6	L.80	148 031 (*)	27	0,066	3	€ 107,00									
	L.100	148 032 (*)	30	0,075	3	€ 118,00									
	L.120	148 033 (*)	33	0,082	3	€ 126,00									
	L.140	148 034 (*)	36	0,091	3	€ 136,00									
	L.160	148 035 (*)	39	0,099	3	€ 144,00									
	L.180	148 036 (*)	42	0,107	3	€ 162,00									
								(*)	PIANO	STRUTTURA	top	structure			
							003	ROVERE	ARGENTO GOLF	oak	golf silver				
							025	GRIGIO	ARGENTO GOLF	grey	golf silver				
							040	BIANCO BR.	ARGENTO GOLF	br. white	golf silver				
							066	NOCE PAVIA	ARGENTO GOLF	pavia walnut	golf silver				
							166	NOCE PAVIA	NOCE PAVIA	pavia walnut	pavia walnut				
							403	ROVERE	BIANCO BR.	oak	br. white				
							440	BIANCO BR.	BIANCO BR.	br. white	br. white				
							466	NOCE PAVIA	BIANCO BR.	pavia walnut	br. white				
							803	ROVERE	STONE GREY	oak	stone grey				
							844	STONE GREY	STONE GREY	stone grey	stone grey				
							866	NOCE PAVIA	STONE GREY	pavia walnut	stone grey				
SCRIVANIE PROF. CM 80 <i>desks depth 80 cms</i>  L x p.80 x H.73,6	L.80	148 041 (*)	32	0,080	3	€ 124,00									
	L.100	148 042 (*)	36	0,092	3	€ 134,00									
	L.120	148 043 (*)	40	0,102	3	€ 146,00									
	L.140	148 044 (*)	44	0,113	3	€ 159,00									
	L.160	148 045 (*)	48	0,124	3	€ 169,00									
	L.180	148 046 (*)	52	0,135	3	€ 180,00									
								(*)	PIANO	STRUTTURA	top	structure			
								003	ROVERE	ARGENTO GOLF	oak	golf silver			
							025	GRIGIO	ARGENTO GOLF	grey	golf silver				
							040	BIANCO BR.	ARGENTO GOLF	br. white	golf silver				
							066	NOCE PAVIA	ARGENTO GOLF	pavia walnut	golf silver				
							166	NOCE PAVIA	NOCE PAVIA	pavia walnut	pavia walnut				
							403	ROVERE	BIANCO BR.	oak	br. white				
							440	BIANCO BR.	BIANCO BR.	br. white	br. white				
							466	NOCE PAVIA	BIANCO BR.	pavia walnut	br. white				
							803	ROVERE	STONE GREY	oak	stone grey				
							844	STONE GREY	STONE GREY	stone grey	stone grey				
							866	NOCE PAVIA	STONE GREY	pavia walnut	stone grey				
ALLUNGO LATERALE DX O SX <i>right or left lateral extension</i>  L.100 x p.60 x H.73,6	L.100	148 061 (*)	21	0,053	4	€ 118,00									
								(*)	PIANO	STRUTTURA	top	structure			
ALLUNGO LATERALE DX O SX PER CASSETTIERA-BASE <i>right or left lateral extension for base-pedestal</i>  L.100 x p.60 x H.2,5	L.100	148 062 (*)	13	0,032	2	€ 58,00									
								(*)	PIANO	STRUTTURA	top	structure			
								166	NOCE PAVIA		pavia walnut				
								200	GRIGIO		grey				
								440	BIANCO BR.		br. white				
								733	ROVERE		oak				
								844	STONE GREY		stone grey				
							DA COMPLETARE SEMPRE CON 1 CASSETTIERA-BASE ART. 396-397 (PAG.32) <i>always complete with 1 art. 396-397 (page 32)</i>								
SCRIVANIA SAGOMATA L.160 PROF. CM 80 <i>shaped desk w 63" depth 80 cms</i>  L.160 x p.80 x H.73,6	L.160	148 063 (*)	48	0,117	3	€ 200,00									
								(*)	PIANO	STRUTTURA	top	structure			
WORKSTATION L.160x120 CON RIDUZIONE <i>workstation w 63"x47 1/4" with reduction</i>  L.160 x p.120 x H.73,6 Fig.DX/right	DX right	L.160	148 066 (*)	56	0,177	4	€ 270,00				(*)	PIANO	STRUTTURA	top	structure
	SX left	L.160	148 067 (*)								003	ROVERE	ARGENTO GOLF	oak	golf silver
								025	GRIGIO	ARGENTO GOLF	grey	golf silver			
								040	BIANCO BR.	ARGENTO GOLF	br. white	golf silver			
								066	NOCE PAVIA	ARGENTO GOLF	pavia walnut	golf silver			
								166	NOCE PAVIA	NOCE PAVIA	pavia walnut	pavia walnut			
								403	ROVERE	BIANCO BR.	oak	br. white			
								440	BIANCO BR.	BIANCO BR.	br. white	br. white			
								466	NOCE PAVIA	BIANCO BR.	pavia walnut	br. white			
								803	ROVERE	STONE GREY	oak	stone grey			
							844	STONE GREY	STONE GREY	stone grey	stone grey				
							866	NOCE PAVIA	STONE GREY	pavia walnut	stone grey				
WORKSTATION SIMMETRICA L.140x140 <i>symmetrical workstation w 55 1/4"x55 1/4"</i>  L.140 x p.140 x H.73,6	L.140	148 068 (*)	61	0,168	4	€ 271,00									
								(*)	PIANO	STRUTTURA	top	structure			

**PIANI sp. 25mm**  
 tops thick. 25mm

**SCRIVANIE CON GAMBE METALLICHE A "T" SAGOMATE E TRAVE FISSA CANALIZZATA**  
*desks with "T" shaped metal legs and fixed cable-way beam*

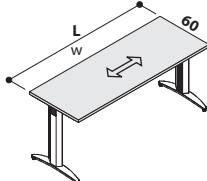
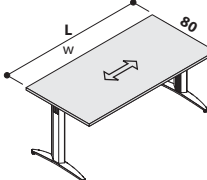
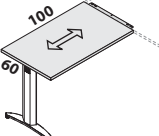
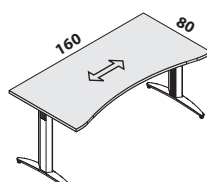
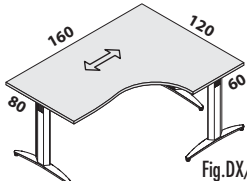
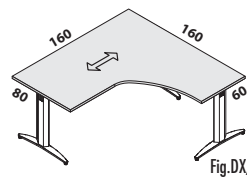
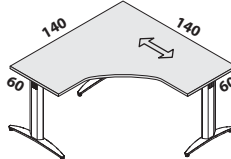
DESCRIZIONE <i>description</i>	L <i>w</i>	CODICE <i>code</i>	KG	M <sup>3</sup>	COLLI	PREZZO <i>price</i>	(*) CODICE FINITURA <i>(*) finish code</i>																																								
SCRIVANIE PROF. CM 60 <i>desks depth 60 cms</i>  L. x p.60 x H.73,6	L80	148 080 (*)	18,2	0,101	4	€ 164,00																																									
	L100	148 081 (*)	20,5	0,109	4	€ 175,00																																									
	L120	148 082 (*)	23	0,116	4	€ 183,00																																									
	L140	148 083 (*)	25,3	0,124	4	€ 193,00																																									
	L160	148 084 (*)	27,7	0,131	4	€ 200,00																																									
	L180	148 085 (*)	30	0,139	4	€ 219,00																																									
	SCRIVANIE PROF. CM 80 <i>desks depth 80 cms</i>  L. x p.80 x H.73,6	L80	148 087 (*)	21,2	0,118	4		€ 171,00																																							
L100		148 088 (*)	24,5	0,129	4	€ 181,00																																									
L120		148 089 (*)	28	0,139	4	€ 193,00																																									
L140		148 090 (*)	31,3	0,149	4	€ 206,00																																									
L160		148 091 (*)	34,7	0,159	4	€ 215,00																																									
L180		148 092 (*)	38	0,170	4	€ 227,00																																									
ALLUNGO L.100 DX O SX (COMPLETO DI STAFFA) <i>right or left extension w 39½" (with stirrup)</i>  L.100 x p.60 x H.73,6		L100	148 093 (*)	18	0,068	4	€ 130,00																																								
SCRIVANIA SAGOMATA L.160 PROF. CM 80 <i>shaped desk w 63" depth 80 cms</i>  L.160 x p.80 x H.73,6	L160	148 094 (*)	34,7	0,152	4	€ 246,00	<table border="1"> <thead> <tr> <th>(*)</th> <th>PIANO</th> <th>STRUTTURA</th> <th>top</th> <th>structure</th> </tr> </thead> <tbody> <tr> <td>003</td> <td>ROVERE</td> <td>ARGENTO</td> <td>oak</td> <td>silver</td> </tr> <tr> <td>025</td> <td>GRIGIO</td> <td>ARGENTO</td> <td>grey</td> <td>silver</td> </tr> <tr> <td>040</td> <td>BIANCO BR.</td> <td>ARGENTO</td> <td>br. white</td> <td>silver</td> </tr> <tr> <td>066</td> <td>NOCE PAVIA</td> <td>ARGENTO</td> <td>pavia walnut</td> <td>silver</td> </tr> <tr> <td>403</td> <td>ROVERE</td> <td>BIANCO</td> <td>oak</td> <td>white</td> </tr> <tr> <td>440</td> <td>BIANCO BR.</td> <td>BIANCO</td> <td>br. white</td> <td>white</td> </tr> <tr> <td>466</td> <td>NOCE PAVIA</td> <td>BIANCO</td> <td>pavia walnut</td> <td>white</td> </tr> </tbody> </table>	(*)	PIANO	STRUTTURA	top	structure	003	ROVERE	ARGENTO	oak	silver	025	GRIGIO	ARGENTO	grey	silver	040	BIANCO BR.	ARGENTO	br. white	silver	066	NOCE PAVIA	ARGENTO	pavia walnut	silver	403	ROVERE	BIANCO	oak	white	440	BIANCO BR.	BIANCO	br. white	white	466	NOCE PAVIA	BIANCO	pavia walnut	white
	(*)	PIANO	STRUTTURA	top	structure																																										
003	ROVERE	ARGENTO	oak	silver																																											
025	GRIGIO	ARGENTO	grey	silver																																											
040	BIANCO BR.	ARGENTO	br. white	silver																																											
066	NOCE PAVIA	ARGENTO	pavia walnut	silver																																											
403	ROVERE	BIANCO	oak	white																																											
440	BIANCO BR.	BIANCO	br. white	white																																											
466	NOCE PAVIA	BIANCO	pavia walnut	white																																											
WORKSTATION L.160x120 CON RIDUZIONE <i>workstation w 63"x47¼" with reduction</i>  Fig.DX/right L.160 x p.120 x H.73,6	DX right L.160	148 095 (*)	43,7	0,227	6	€ 340,00																																									
	SX left L.160	148 096 (*)																																													
WORKSTATION L.160x160 CON RIDUZIONE <i>workstation w 63"x63" with reduction</i>  Fig.DX/right L.160 x p.160 x H.73,6	DX right L.160	148 097 (*)	58,7	0,281	6	€ 428,00																																									
	SX left L.160	148 098 (*)																																													
WORKSTATION SIMMETRICA L.140x140 <i>symmetrical workstation w 55¼"x55¼"</i>  L.140 x p.140 x H.73,6	L140	148 099 (*)	47,3	0,217	6	€ 344,00																																									

**PIANI sp. 25mm**  
 tops thick. 25mm

**SCRIVANIE CON GAMBE A PONTE**
*desks with bridge legs*

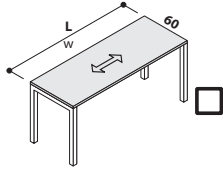
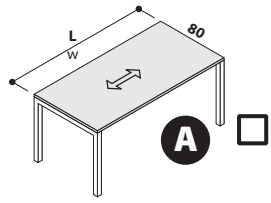
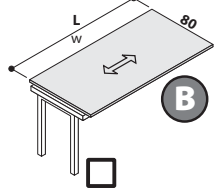
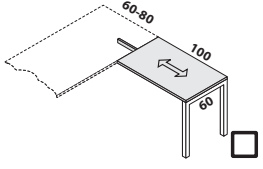
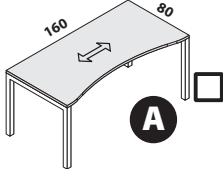
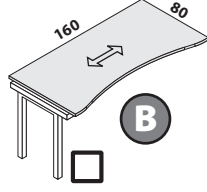
DESCRIZIONE <i>description</i>	L w	CODICE <i>code</i>	KG	M <sup>3</sup>	COLLI	PREZZO <i>price</i>	(*) CODICE FINITURA <i>(*) finish code</i>
SCRIVANIE PROF. CM 60 <i>desks depth 60 cms</i>  L. x p.60 x H.73,6	L.100	148 101 (*)	28	0,083	3	€ 239,00	
	L.120	148 102 (*)	31	0,089	3	€ 249,00	
	L.140	148 103 (*)	33,6	0,098	3	€ 262,00	
	L.160	148 104 (*)	35,6	0,108	3	€ 270,00	
	L.180	148 105 (*)	39	0,113	3	€ 287,00	
SCRIVANIE PROF. CM 80 <i>desks depth 80 cms</i>  L. x p.80 x H.73,6	L.100	148 106 (*)	33	0,108	3	€ 257,00	
	L.120	148 107 (*)	37	0,117	3	€ 271,00	
	L.140	148 108 (*)	40,6	0,129	3	€ 287,00	
	L.160	148 109 (*)	43,6	0,141	3	€ 297,00	
	L.180	148 110 (*)	48	0,149	3	€ 307,00	
SCRIVANIE PROF. CM 80 CON GAMBA INTERMEDIA <i>desks depth 80 cms with central bridge leg</i>  L. x p.80 x H.73,6	L.100	148 111 (*)	26	0,118	3	€ 168,00	
	L.120	148 112 (*)	30	0,127	3	€ 182,00	
	L.140	148 113 (*)	33,6	0,139	3	€ 198,00	
	L.160	148 114 (*)	36,6	0,151	3	€ 208,00	
	L.180	148 115 (*)	41	0,159	3	€ 218,00	
ALLUNGO PER SCRIVANIE PROF. CM 60-80 <i>extension for desks depth 60 cms-31½"</i>  L.100 x p.60 x H.73,6	L.100	148 121 (*)	19,5	0,073	3	€ 151,00	
SCRIVANIA SAGOMATA PROF. CM 80 <i>shaped desk depth 80 cms</i>  L160. x p.80 x H.73,6	L.160	148 122 (*)	43,6	0,134	3	€ 328,00	
SCRIVANIA SAGOMATA PROF. CM 80 CON GAMBA INTERMEDIA <i>shaped desk depth 80 cms with central bridge leg</i>  L160 x p.80 x H.73,6	L.160	148 123 (*)	36,6	0,144	3	€ 239,00	

(*)	PIANO	STRUTTURA	top	structure
003	ROVERE	ARGENTO	oak	silver
025	GRIGIO	ARGENTO	grey	silver
040	BIANCO BR.	ARGENTO	br. white	silver
066	NOCE PAVIA	ARGENTO	pavia walnut	silver
403	ROVERE	BIANCO	oak	white
440	BIANCO BR.	BIANCO	br. white	white
466	NOCE PAVIA	BIANCO	pavia walnut	white

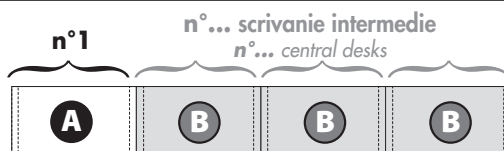

**SCRIVANIE prof. cm 80**  
*DESKS depth 80 cms*

 SPOSTARE LA GAMBA IN POSIZIONE TERMINALE  
 move the leg in terminal position

 ⇔ = VENATURA LEGNO  
 wood veining

**PIANI sp. 25mm**  
 tops thick. 25mm

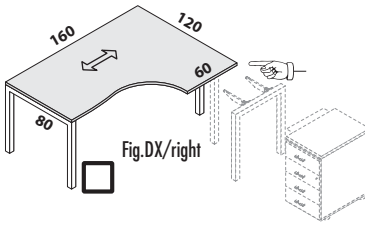
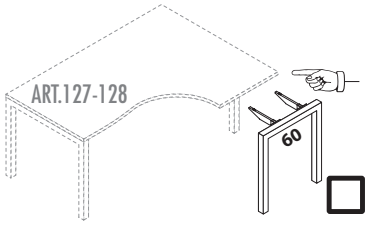
**WORKSTATION CON GAMBE A PONTE**

workstation with bridge legs

DESCRIZIONE description	L w	CODICE code	KG	M <sup>3</sup>	COLLI	PREZZO price	(*) CODICE FINITURA (*) finish code					
WORKSTATION L.160x120 <b>CON RIDUZIONE</b> workstation w 63"x47¼" <b>with reduction</b>    L.160 x p.120 x H.73,6	<b>DX</b> right	L.160	<b>148 127 (*)</b>	47,6	0,172	3	<b>€ 350,00</b>					
	<b>SX</b> left	L.160	<b>148 128 (*)</b>									
	<b>COMPLETARE SEMPRE CON / always complete with:</b>											
		N°1 ART.129 GAMBA QUADRATA / squared leg										
	OPPURE or	N°1 ART.117 GAMBA A PONTE CON TRAVI A SBALZO PROF. CM 60 / bridge leg with overanging beams										
OPPURE or	N°1 ART.396-397 CASSETTIERA-BASE PROF. CM 60 / base pedestal depth 60 cms											
OPPURE or	N°1 ART.401 TOP PROF. CM 60 / top depth 60 cms											
OPPURE or	N°1 ART.467 STAFFA / stirrup											
OPPURE or	N°1 ART.396-397 CASSETTIERA-BASE PROF. CM 60 / base pedestal depth 60 cms											
OPPURE or	N°1 ART.555 ESTENSIONI PROF. CM 60 / extension depth 60 cms											
								(*)	PIANO	STRUTTURA	top	structure
								003	ROVERE	ARGENTO	oak	silver
								025	GRIGIO	ARGENTO	grey	silver
								040	BIANCO BR.	ARGENTO	br. white	silver
								066	NOCE PAVIA	ARGENTO	pavia walnut	silver
								403	ROVERE	BIANCO	oak	white
								440	BIANCO BR.	BIANCO	br. white	white
								466	NOCE PAVIA	BIANCO	pavia walnut	white
GAMBA A PONTE CON TRAVI A SBALZO (PER WORKSTATION ART.127-128) bridge leg with overanging beams (for workstation art.127-128)    p.60 x H.71,1			<b>148 117 (*)</b>	7	0,032	2	<b>€ 112,00</b>					
									(*)			
GAMBA QUADRATA squared leg    H.71,1			<b>148 129 (*)</b>	3	0,009	1	<b>€ 37,00</b>					
									000	ARGENTO		silver
								440	BIANCO		white	

 ⇄ = VENATURA LEGNO  
 wood veining

**BENCH PROF.125,2 CON GAMBE A PONTE**

bench depth 125,2 cms with bridge legs

PIANI sp. 25mm  
tops thick. 25mm

DESCRIZIONE description	L w	CODICE code	KG	M <sup>3</sup>	COLLI	PREZZO price	(*) CODICE FINITURA (*) finish code																																														
<p>BENCH PROF. CM 125,2 bench depth 125,2 cms</p> <p>L. x p.125,2 x H.73,6</p>	L120	148 940 (*)	53	0,177	5	€ 406,00	<table border="1"> <thead> <tr> <th>(*)</th> <th>PIANO</th> <th>STRUTTURA</th> <th>top</th> <th>structure</th> </tr> </thead> <tbody> <tr> <td>003</td> <td>ROVERE</td> <td>ARGENTO</td> <td>oak</td> <td>silver</td> </tr> <tr> <td>025</td> <td>GRIGIO</td> <td>ARGENTO</td> <td>grey</td> <td>silver</td> </tr> <tr> <td>040</td> <td>BIANCO BR.</td> <td>ARGENTO</td> <td>br. white</td> <td>silver</td> </tr> <tr> <td>066</td> <td>NOCE PAVIA</td> <td>ARGENTO</td> <td>pavia walnut</td> <td>silver</td> </tr> <tr> <td>403</td> <td>ROVERE</td> <td>BIANCO</td> <td>oak</td> <td>white</td> </tr> <tr> <td>440</td> <td>BIANCO BR.</td> <td>BIANCO</td> <td>br. white</td> <td>white</td> </tr> <tr> <td>466</td> <td>NOCE PAVIA</td> <td>BIANCO</td> <td>pavia walnut</td> <td>white</td> </tr> </tbody> </table>	(*)	PIANO	STRUTTURA	top	structure	003	ROVERE	ARGENTO	oak	silver	025	GRIGIO	ARGENTO	grey	silver	040	BIANCO BR.	ARGENTO	br. white	silver	066	NOCE PAVIA	ARGENTO	pavia walnut	silver	403	ROVERE	BIANCO	oak	white	440	BIANCO BR.	BIANCO	br. white	white	466	NOCE PAVIA	BIANCO	pavia walnut	white	L140	148 941 (*)	58	0,196	5	€ 432,00
	(*)	PIANO	STRUTTURA	top	structure																																																
	003	ROVERE	ARGENTO	oak	silver																																																
	025	GRIGIO	ARGENTO	grey	silver																																																
	040	BIANCO BR.	ARGENTO	br. white	silver																																																
066	NOCE PAVIA	ARGENTO	pavia walnut	silver																																																	
403	ROVERE	BIANCO	oak	white																																																	
440	BIANCO BR.	BIANCO	br. white	white																																																	
466	NOCE PAVIA	BIANCO	pavia walnut	white																																																	
L160	148 942 (*)	62	0,214	5	€ 448,00																																																
L180	148 943 (*)	69	0,225	5	€ 482,00																																																
<p>BENCH PROF. CM 125,2 CON GAMBA INTERMEDIA bench depth 125,2 cms with central bridge leg</p> <p>L. x p.125,2 x H.73,6</p>	L120	148 945 (*)	45	0,202	5	€ 296,00																																															
	L140	148 946 (*)	50	0,221	5	€ 322,00																																															
	L160	148 947 (*)	54	0,239	5	€ 338,00																																															
	L180	148 948 (*)	61	0,250	5	€ 372,00																																															

**BENCH PROF.165,2 CON GAMBE A PONTE**

bench depth 165,2 cms with bridge legs

<p>BENCH PROF. CM 165,2 bench depth 165,2 cms</p> <p>L. x p.165,2 x H.73,6</p>	L120	148 955 (*)	66	0,234	5	€ 487,00	<table border="1"> <thead> <tr> <th>(*)</th> <th>PIANO</th> <th>STRUTTURA</th> <th>top</th> <th>structure</th> </tr> </thead> <tbody> <tr> <td>003</td> <td>ROVERE</td> <td>ARGENTO</td> <td>oak</td> <td>silver</td> </tr> <tr> <td>025</td> <td>GRIGIO</td> <td>ARGENTO</td> <td>grey</td> <td>silver</td> </tr> <tr> <td>040</td> <td>BIANCO BR.</td> <td>ARGENTO</td> <td>br. white</td> <td>silver</td> </tr> <tr> <td>066</td> <td>NOCE PAVIA</td> <td>ARGENTO</td> <td>pavia walnut</td> <td>silver</td> </tr> <tr> <td>403</td> <td>ROVERE</td> <td>BIANCO</td> <td>oak</td> <td>white</td> </tr> <tr> <td>440</td> <td>BIANCO BR.</td> <td>BIANCO</td> <td>br. white</td> <td>white</td> </tr> <tr> <td>466</td> <td>NOCE PAVIA</td> <td>BIANCO</td> <td>pavia walnut</td> <td>white</td> </tr> </tbody> </table>	(*)	PIANO	STRUTTURA	top	structure	003	ROVERE	ARGENTO	oak	silver	025	GRIGIO	ARGENTO	grey	silver	040	BIANCO BR.	ARGENTO	br. white	silver	066	NOCE PAVIA	ARGENTO	pavia walnut	silver	403	ROVERE	BIANCO	oak	white	440	BIANCO BR.	BIANCO	br. white	white	466	NOCE PAVIA	BIANCO	pavia walnut	white	L140	148 956 (*)	73	0,258	5	€ 519,00
	(*)	PIANO	STRUTTURA	top	structure																																																
	003	ROVERE	ARGENTO	oak	silver																																																
	025	GRIGIO	ARGENTO	grey	silver																																																
	040	BIANCO BR.	ARGENTO	br. white	silver																																																
066	NOCE PAVIA	ARGENTO	pavia walnut	silver																																																	
403	ROVERE	BIANCO	oak	white																																																	
440	BIANCO BR.	BIANCO	br. white	white																																																	
466	NOCE PAVIA	BIANCO	pavia walnut	white																																																	
L160	148 957 (*)	79	0,282	5	€ 539,00																																																
L180	148 958 (*)	88	0,298	5	€ 559,00																																																
<p>BENCH PROF. CM 165,2 CON GAMBA INTERMEDIA bench depth 165,2 cms with central bridge leg</p> <p>L. x p.165,2 x H.73,6</p>	L120	148 960 (*)	55	0,148	5	€ 330,00																																															
	L140	148 961 (*)	62	0,172	5	€ 362,00																																															
	L160	148 962 (*)	68	0,196	5	€ 382,00																																															
	L180	148 963 (*)	77	0,212	5	€ 402,00																																															

COPPIA PANNELLI DI TAMPONAMENTO WIRE-MANAGER  
PER GAMBA A PONTE INTERMEDIA BENCH  
set of 2 wire-manager panels for central bridge leg (BENCH)

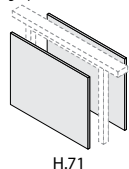

H.71

148 148 (*)	20	0,029	1	€ 66,00	<table border="1"> <thead> <tr> <th>(*)</th> <th>MELAMINICO</th> <th>melamine</th> </tr> </thead> <tbody> <tr> <td>005</td> <td>ARGENTO GOLF</td> <td>golf silver</td> </tr> <tr> <td>440</td> <td>BIANCO BR.</td> <td>br. white</td> </tr> </tbody> </table>	(*)	MELAMINICO	melamine	005	ARGENTO GOLF	golf silver	440	BIANCO BR.	br. white
(*)	MELAMINICO	melamine												
005	ARGENTO GOLF	golf silver												
440	BIANCO BR.	br. white												
<b>UTILIZZABILI SU BENCH PROF. CM 125,2 E 165,2</b> usable on bench depth 125,2-165,2 cms														

**BENCH prof. cm 125,2 (cm 60+60)**  
BENCH depth 125,2 cms (60+60 cms)

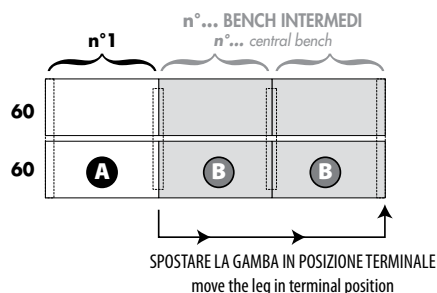

**BENCH prof. cm 165,2 (cm 80+80)**  
BENCH depth 165,2 (80+80 cms)

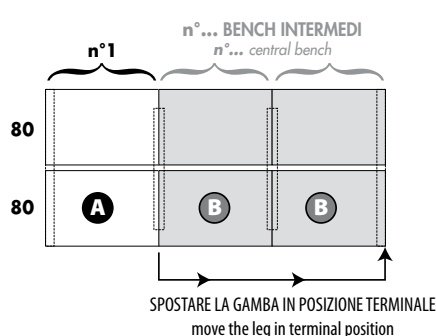

**SCHEMA DI UTILIZZO BASAMENTI METALLICI**

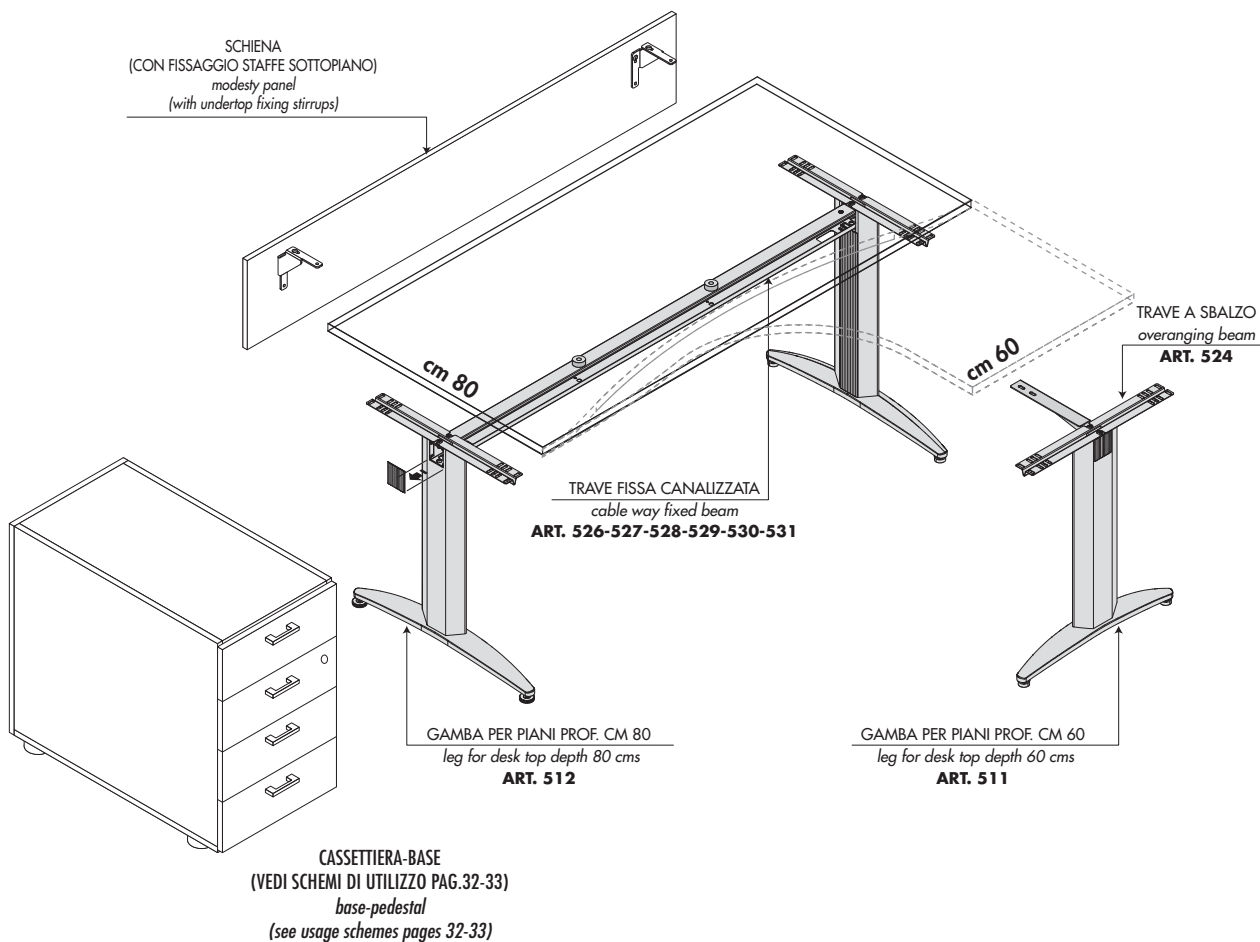

*basement use scheme*

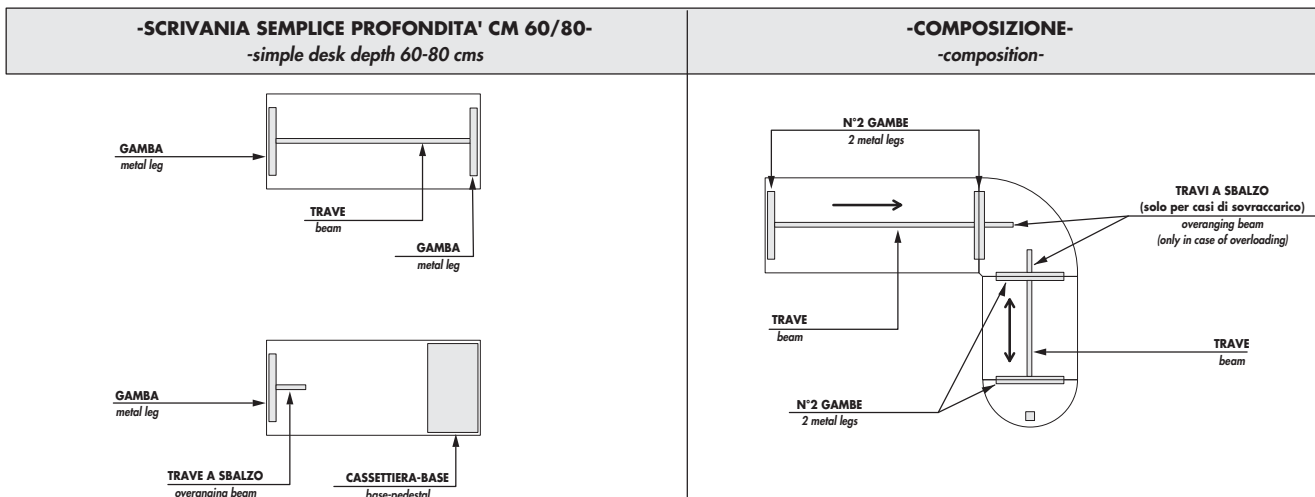

**TUTTE LE GAMBE METALLICHE POSSONO ESSERE POSTE IN POSIZIONE CENTRALE**  
*all the metallic legs may be placed in central position*



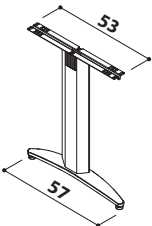
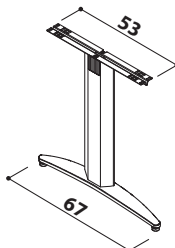

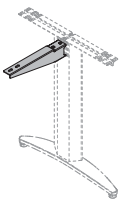
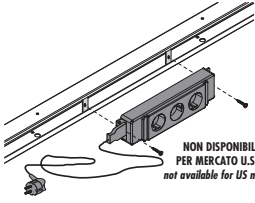
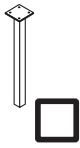
SOSTEGNI SOTTOPIANO PER SCRIVANIE								
undertop stirrups for desks								
DESCRIZIONE description	L w	CODICE code	KG	M <sup>3</sup>	COLLI	PREZZO price	(*) CODICE FINITURA (*) finish code	
GAMBA SINGOLA A "T" PER PIANI PROF. CM 60 single "T" leg for desk top depth 60 cms 		148 511 (*)	4	0,035	1	€ 55,00		
							(*)	
							GAMBA	
							leg	
							000	
							ARGENTO	
							silver	
							440	
							BIANCO	
							white	
GAMBA SINGOLA A "T" PER PIANI PROF. CM 80 single "T" leg for desk top depth 80 cms 		148 512 (*)	4,5	0,038	1	€ 55,00		
							(*)	
							GAMBA	
							leg	
							000	
							ARGENTO	
							silver	
							440	
							BIANCO	
							white	
TRAVI CANALIZZATE PER SCRIVANIE E WORKSTATION cable-way beams for desks and workstation 	PER PIANI for desktops							
	L.80	148 526 (*)	1,2	0,006	1	€ 21,00		
	L.100	148 527 (*)	1,5	0,009	1	€ 23,00		
	L.120	148 528 (*)	2	0,010	1	€ 26,00		
	L.140	148 529 (*)	2,3	0,012	1	€ 29,00		
	L.160	148 530 (*)	2,7	0,014	1	€ 31,00		
	L.180	148 531 (*)	3	0,016	1	€ 35,00		
							(*)	
							TRAVI	
							beams	
							000	
							ARGENTO	
							silver	
							440	
							BIANCO	
							white	
TRAVE A SBALZO PER SCRIVANIE, PENISOLE, ALLUNGHI E ANGOLI DI RACCORDO overanging beam for desks, terminals, extensions and joining segments 		148 524 (*)	1	0,001	1	€ 17,00		
							(*)	
							TRAVI	
							beams	
							000	
							ARGENTO	
							silver	
							440	
							BIANCO	
							white	
KIT 2 PIASTRINI+ KIT ELETTRIFICAZIONE SINGOLO CON PRESE SCHUKO E CAVO DI ALIMENTAZIONE DI MT. 2,00 kit with 2 plates+single electrification kit with SCHUKO sockets and power cable w 2 lmt. 		148 525 (*)	1	0,006	1	€ 91,00		
							(*)	
							KIT PIASTRINI	
							plates kit	
							000	
							ARGENTO	
							silver	
							KIT PRESE e CAVO: COLORE NERO sockets kit and cable: black color	
GAMBA QUADRATA squared leg 		148 129 (*)	3	0,009	1	€ 37,00		
							(*)	
							GAMBA	
							leg	
							000	
							ARGENTO	
							silver	
							440	
							BIANCO	
							white	

# OXI\_TREND

**SCRIVANIE CON GAMBE METALLICHE A "T" SQUADRATE E TRAVE FISSA CANALIZZATA**
**PIANI sp. 25mm**  
 tops thick. 25mm

*desks with "T" squared metal legs and fixed cable-way beam*

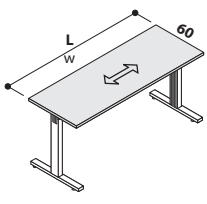
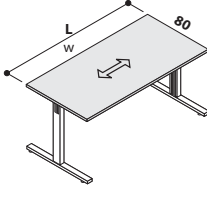
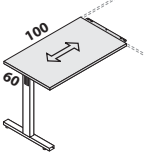
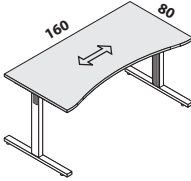
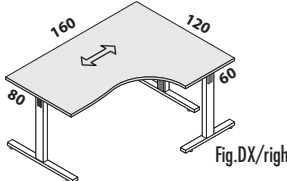
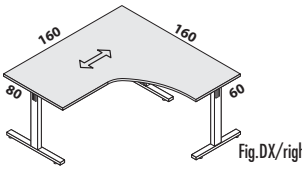
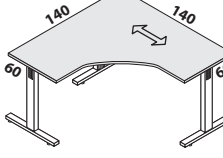
DESCRIZIONE <i>description</i>	L <i>w</i>	CODICE <i>code</i>	KG	M <sup>3</sup>	COLLI	PREZZO <i>price</i>	(*) CODICE FINITURA <i>(*) finish code</i>
SCRIVANIE PROF. CM 60 <i>desks depth 60 cms</i>  L. x p.60 x H.73,6	L.80	148 170 (*)	22,2	0,113	4	€ 186,00	
	L.100	148 171 (*)	24,5	0,121	4	€ 197,00	
	L.120	148 172 (*)	27	0,129	4	€ 205,00	
	L.140	148 173 (*)	29,3	0,136	4	€ 215,00	
	L.160	148 174 (*)	31,7	0,144	4	€ 222,00	
	L.180	148 175 (*)	34	0,151	4	€ 241,00	
SCRIVANIE PROF. CM 80 <i>desks depth 80 cms</i>  L. x p.80 x H.73,6	L.80	148 176 (*)	11	0,035	4	€ 195,00	
	L.100	148 177 (*)	29,5	0,149	4	€ 205,00	
	L.120	148 178 (*)	33	0,159	4	€ 217,00	
	L.140	148 179 (*)	36,3	0,169	4	€ 230,00	
	L.160	148 180 (*)	39,7	0,179	4	€ 239,00	
	L.180	148 181 (*)	43	0,190	4	€ 251,00	
ALLUNGO L.100 DX O SX (COMPLETO DI STAFFA) <i>right or left extension w 39½" (with stirrup)</i>  L.100 x p.60 x H.73,6	L.100	148 183 (*)	20	0,074	4	€ 141,00	
SCRIVANIA SAGOMATA L.160 PROF. CM 80 <i>shaped desk w 63" depth 80 cms</i>  L.160 x p.80 x H.73,6	L.160	148 185 (*)	39,7	0,172	4	€ 270,00	
WORKSTATION L.160x120 CON RIDUZIONE <i>workstation w 63"x47¼" with reduction</i>  Fig.DX/right L.160 x p.120 x H.73,6	DX right	L.160	148 186 (*)	50,7	0,253	6	€ 375,00
	SX left	L.160	148 187 (*)				
WORKSTATION L.160x160 CON RIDUZIONE <i>workstation w 63"x63" with reduction</i>  Fig.DX/right L.160 x p.160 x H.73,6	DX right	L.160	148 188 (*)	65,7	0,307	6	€ 463,00
	SX left	L.160	148 189 (*)				
WORKSTATION SIMMETRICA L.140x140 <i>symmetrical workstation w 55¼"x55¼"</i>  L.140 x p.140 x H.73,6	L.140	148 190 (*)	53,3	0,235	6	€ 377,00	

(*)	PIANO	STRUTTURA	top	structure
003	ROVERE	ARGENTO	oak	silver
040	BIANCO BR.	ARGENTO	br. white	silver
066	NOCE PAVIA	ARGENTO	pavia walnut	silver
403	ROVERE	BIANCO	oak	white
440	BIANCO BR.	BIANCO	br. white	white
466	NOCE PAVIA	BIANCO	pavia walnut	white
803	ROVERE	STONE GREY	oak	stone grey
844	STONE GREY	STONE GREY	stone grey	stone grey
866	NOCE PAVIA	STONE GREY	pavia walnut	stone grey

PIANI sp. 25mm  
tops thick. 25mm

**SCRIVANIE CON GAMBE A PONTE TRAPEZOIDALI**

*desks with trapezoid bridge legs*

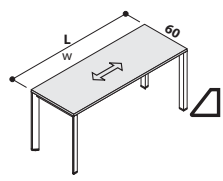
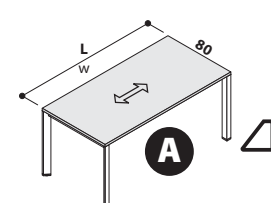
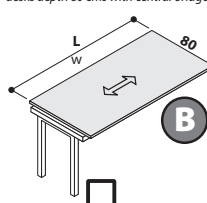
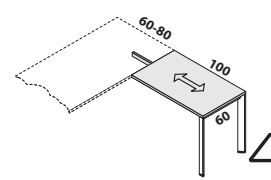
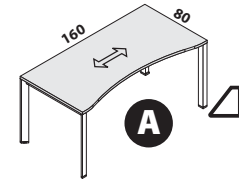
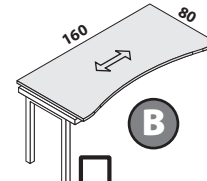

DESCRIZIONE <i>description</i>	L w	CODICE <i>code</i>	KG	M <sup>3</sup>	COLLI	PREZZO <i>price</i>	(*) CODICE FINITURA <i>(*) finish code</i>
SCRIVANIE PROF. CM 60 <i>desks depth 60 cms</i>  L. x p.60 x H.73,6	L.100	148 215 (*)	29	0,079	3	€ 260,00	
	L.120	148 216 (*)	32	0,085	3	€ 270,00	
	L.140	148 217 (*)	34,6	0,094	3	€ 283,00	
	L.160	148 218 (*)	36,6	0,103	3	€ 291,00	
	L.180	148 219 (*)	40	0,109	3	€ 308,00	
SCRIVANIE PROF. CM 80 <i>desks depth 80 cms</i>  L. x p.80 x H.73,6	L.100	148 221 (*)	33	0,096	3	€ 272,00	
	L.120	148 222 (*)	37	0,105	3	€ 286,00	
	L.140	148 223 (*)	40,6	0,117	3	€ 302,00	
	L.160	148 224 (*)	43,6	0,129	3	€ 312,00	
	L.180	148 225 (*)	48	0,137	3	€ 322,00	
SCRIVANIE PROF. CM 80 CON GAMBA INTERMEDIA <i>desks depth 80 cms with central bridge leg</i>  L. x p.80 x H.73,6	L.100	148 111 (*)	26	0,118	3	€ 168,00	
	L.120	148 112 (*)	30	0,127	3	€ 182,00	
	L.140	148 113 (*)	33,6	0,139	3	€ 198,00	
	L.160	148 114 (*)	36,6	0,151	3	€ 208,00	
	L.180	148 115 (*)	41	0,159	3	€ 218,00	
ALLUNGO PER SCRIVANIE PROF. CM 60-80 <i>extension for desks depth 60 cms-31 1/2"</i>  L.100 x p.60 x H.73,6	L.100	148 233 (*)	21	0,082	4	€ 181,00	
SCRIVANIA SAGOMATA PROF. CM 80 <i>shaped desk depth 80 cms</i>  L160. x p.80 x H.73,6	L.160	148 234 (*)	43,6	0,122	3	€ 343,00	
SCRIVANIA SAGOMATA PROF. CM 80 CON GAMBA INTERMEDIA <i>shaped desk depth 80 cms with central bridge leg</i>  L160 x p.80 x H.73,6	L.160	148 123 (*)	36,6	0,144	3	€ 239,00	

(*)	PIANO	STRUTTURA	top	structure
003	ROVERE	ARGENTO	oak	silver
040	BIANCO BR.	ARGENTO	br. white	silver
066	NOCE PAVIA	ARGENTO	pavia walnut	silver
403	ROVERE	BIANCO	oak	white
440	BIANCO BR.	BIANCO	br. white	white
466	NOCE PAVIA	BIANCO	pavia walnut	white
803	ROVERE	STONE GREY	oak	stone grey
844	STONE GREY	STONE GREY	stone grey	stone grey
866	NOCE PAVIA	STONE GREY	pavia walnut	stone grey

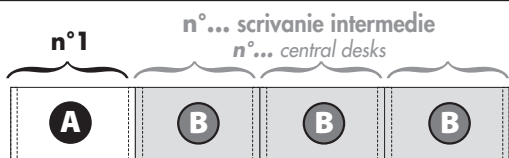
**SCRIVANIE prof. cm 80**  
*DESKS depth 80 cms*

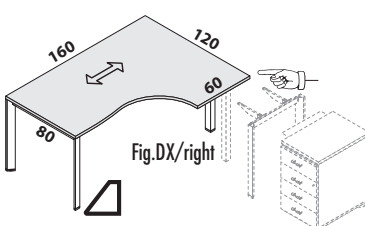
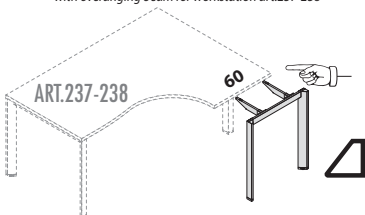

SPOSTARE LA GAMBA IN POSIZIONE TERMINALE  
*move the leg in terminal position*

WORKSTATION CON GAMBE A PONTE TRAPEZOIDALI workstation with trapezoid bridge legs							PIANI sp. 25mm tops thick. 25mm																																																			
DESCRIZIONE description	L w	CODICE code	KG	M <sup>3</sup>	COLLI	PREZZO price	(*) CODICE FINITURA (*) finish code																																																			
WORKSTATION L.160x120 CON RIDUZIONE workstation w 63"x47 1/4" with reduction   Fig.DX/right  L.160 x p.120 x H.73,6	DX right	L.160	148 237 (*)	47,6	0,160	3	€ 365,00																																																			
	SX left	L.160	148 238 (*)																																																							
	COMPLETARE SEMPRE CON / always complete with:																																																									
		N°1 ART.129 GAMBA QUADRATA / squared leg																																																								
	OPPURE or	N°1 ART.480 GAMBA A PONTE CON TRAVI A SBALZO PROF. CM 60 / bridge leg with overanging beams depth 23%																																																								
	OPPURE or	N°1 ART.396-397 CASSETTIERA-BASE PROF. CM 60 / base pedestal depth 60 cms N°1 ART.401 TOP PROF. CM 60 / top depth 60 cms N°1 ART.467 STAFFA / stirrup																																																								
OPPURE or	N°1 ART.396-397 CASSETTIERA-BASE PROF. CM 60 / base pedestal depth 60 cms N°1 ART.555 ESTENSIONI PROF. CM 60 / extension depth 60 cms																																																									
<table border="1"> <thead> <tr> <th>(*)</th> <th>PIANO</th> <th>STRUTTURA</th> <th>top</th> <th>structure</th> </tr> </thead> <tbody> <tr> <td>003</td> <td>ROVERE</td> <td>ARGENTO</td> <td>oak</td> <td>silver</td> </tr> <tr> <td>040</td> <td>BIANCO BR.</td> <td>ARGENTO</td> <td>br. white</td> <td>silver</td> </tr> <tr> <td>066</td> <td>NOCE PAVIA</td> <td>ARGENTO</td> <td>pavia walnut</td> <td>silver</td> </tr> <tr> <td>403</td> <td>ROVERE</td> <td>BIANCO</td> <td>oak</td> <td>white</td> </tr> <tr> <td>440</td> <td>BIANCO BR.</td> <td>BIANCO</td> <td>br. white</td> <td>white</td> </tr> <tr> <td>466</td> <td>NOCE PAVIA</td> <td>BIANCO</td> <td>pavia walnut</td> <td>white</td> </tr> <tr> <td>803</td> <td>ROVERE</td> <td>STONE GREY</td> <td>oak</td> <td>stone grey</td> </tr> <tr> <td>844</td> <td>STONE GREY</td> <td>STONE GREY</td> <td>stone grey</td> <td>stone grey</td> </tr> <tr> <td>866</td> <td>NOCE PAVIA</td> <td>STONE GREY</td> <td>pavia walnut</td> <td>stone grey</td> </tr> </tbody> </table>									(*)	PIANO	STRUTTURA	top	structure	003	ROVERE	ARGENTO	oak	silver	040	BIANCO BR.	ARGENTO	br. white	silver	066	NOCE PAVIA	ARGENTO	pavia walnut	silver	403	ROVERE	BIANCO	oak	white	440	BIANCO BR.	BIANCO	br. white	white	466	NOCE PAVIA	BIANCO	pavia walnut	white	803	ROVERE	STONE GREY	oak	stone grey	844	STONE GREY	STONE GREY	stone grey	stone grey	866	NOCE PAVIA	STONE GREY	pavia walnut	stone grey
(*)	PIANO	STRUTTURA	top	structure																																																						
003	ROVERE	ARGENTO	oak	silver																																																						
040	BIANCO BR.	ARGENTO	br. white	silver																																																						
066	NOCE PAVIA	ARGENTO	pavia walnut	silver																																																						
403	ROVERE	BIANCO	oak	white																																																						
440	BIANCO BR.	BIANCO	br. white	white																																																						
466	NOCE PAVIA	BIANCO	pavia walnut	white																																																						
803	ROVERE	STONE GREY	oak	stone grey																																																						
844	STONE GREY	STONE GREY	stone grey	stone grey																																																						
866	NOCE PAVIA	STONE GREY	pavia walnut	stone grey																																																						
GAMBA A "PONTE" A SEZIONE TRAPEZOIDALE CON TRAVI A SBALZO PER WORKSTATION ART.237-238 "bridge" leg with trapezoidal section with overanging beam for workstation art.237-238   ART.237-238  p.60 x H.71,1																																																										
<table border="1"> <tbody> <tr> <td>p.60</td> <td>148 480 (*)</td> <td>7,5</td> <td>0,039</td> <td>2</td> <td>€ 116,00</td> <td colspan="2"></td> </tr> <tr> <td colspan="9"> <table border="1"> <thead> <tr> <th>(*)</th> <th>PIANO</th> <th>STRUTTURA</th> <th>top</th> <th>structure</th> </tr> </thead> <tbody> <tr> <td>000</td> <td>ARGENTO</td> <td></td> <td>silver</td> <td></td> </tr> <tr> <td>440</td> <td>BIANCO</td> <td></td> <td>white</td> <td></td> </tr> <tr> <td>844</td> <td>STONE GREY</td> <td></td> <td>stone grey</td> <td></td> </tr> </tbody> </table> </td> </tr> </tbody> </table>									p.60	148 480 (*)	7,5	0,039	2	€ 116,00			<table border="1"> <thead> <tr> <th>(*)</th> <th>PIANO</th> <th>STRUTTURA</th> <th>top</th> <th>structure</th> </tr> </thead> <tbody> <tr> <td>000</td> <td>ARGENTO</td> <td></td> <td>silver</td> <td></td> </tr> <tr> <td>440</td> <td>BIANCO</td> <td></td> <td>white</td> <td></td> </tr> <tr> <td>844</td> <td>STONE GREY</td> <td></td> <td>stone grey</td> <td></td> </tr> </tbody> </table>									(*)	PIANO	STRUTTURA	top	structure	000	ARGENTO		silver		440	BIANCO		white		844	STONE GREY		stone grey														
p.60	148 480 (*)	7,5	0,039	2	€ 116,00																																																					
<table border="1"> <thead> <tr> <th>(*)</th> <th>PIANO</th> <th>STRUTTURA</th> <th>top</th> <th>structure</th> </tr> </thead> <tbody> <tr> <td>000</td> <td>ARGENTO</td> <td></td> <td>silver</td> <td></td> </tr> <tr> <td>440</td> <td>BIANCO</td> <td></td> <td>white</td> <td></td> </tr> <tr> <td>844</td> <td>STONE GREY</td> <td></td> <td>stone grey</td> <td></td> </tr> </tbody> </table>									(*)	PIANO	STRUTTURA	top	structure	000	ARGENTO		silver		440	BIANCO		white		844	STONE GREY		stone grey																															
(*)	PIANO	STRUTTURA	top	structure																																																						
000	ARGENTO		silver																																																							
440	BIANCO		white																																																							
844	STONE GREY		stone grey																																																							
GAMBA QUADRATA squared leg   H.71,1																																																										
<table border="1"> <tbody> <tr> <td></td> <td>148 129 (*)</td> <td>3</td> <td>0,009</td> <td>1</td> <td>€ 37,00</td> <td colspan="2"></td> </tr> </tbody> </table>										148 129 (*)	3	0,009	1	€ 37,00																																												
	148 129 (*)	3	0,009	1	€ 37,00																																																					

### SCRIVANIE CON GAMBE A PONTE TRAPEZOIDALI (PIANI IN VETRO FLOAT SP. MM 10 RETROLACCATO) desks with trapezoid bridge legs (square edged rear-lacquered float glazed tops thick.10 mm)

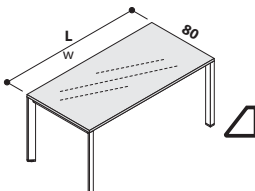
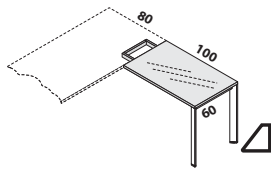
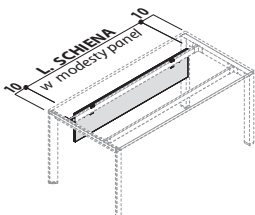
SCRIVANIE PROF. CM 80 CON PIANO IN VETRO desks depth 80 cms with glass top   L. x p.80 x H.73,6	PIANO sp.10mm top thick. 10mm		L.160	148 241 (*)	41,1	0,110	4	€ 535,00																						
	L.180	148 242 (*)	46,5	0,113	4	€ 570,00																								
<table border="1"> <thead> <tr> <th>(*)</th> <th>PIANO</th> <th>STRUTTURA</th> <th>top</th> <th>structure</th> </tr> </thead> <tbody> <tr> <td>079</td> <td>BIANCO</td> <td>ARGENTO</td> <td>white</td> <td>silver</td> </tr> <tr> <td>479</td> <td>BIANCO</td> <td>BIANCO</td> <td>white</td> <td>white</td> </tr> <tr> <td>872</td> <td>TORTORA</td> <td>STONE GREY</td> <td>grey beige</td> <td>stone grey</td> </tr> </tbody> </table>											(*)	PIANO	STRUTTURA	top	structure	079	BIANCO	ARGENTO	white	silver	479	BIANCO	BIANCO	white	white	872	TORTORA	STONE GREY	grey beige	stone grey
(*)	PIANO	STRUTTURA	top	structure																										
079	BIANCO	ARGENTO	white	silver																										
479	BIANCO	BIANCO	white	white																										
872	TORTORA	STONE GREY	grey beige	stone grey																										
ALLUNGO DX O SX CON PIANO IN VETRO right or left extension with glass top   L.100 x p.60 x H.73,6	PIANO sp.10mm top thick. 10mm		L.100	148 243 (*)	24,5	0,104	3	€ 306,00																						
SCHIENA PER SCRIVANIE CON PIANO IN VETRO modesty panels for desks with glass top   L. x p.1,8 x H.30	L. SCHIENA w modesty panel		L.140	148 247 (*)	6,2	0,017	2	€ 48,00																						
	L.160	148 248 (*)	7	0,022	2	€ 51,00																								
	<table border="1"> <thead> <tr> <th colspan="2">PROSPETTO INFORMATIVO information sheet</th> </tr> <tr> <th>SCHIENA modesty panel</th> <th>PER SCRIVANIE for desks</th> </tr> </thead> <tbody> <tr> <td>ART.247</td> <td>ART.241</td> </tr> <tr> <td>ART.248</td> <td>ART.242</td> </tr> </tbody> </table>									PROSPETTO INFORMATIVO information sheet		SCHIENA modesty panel	PER SCRIVANIE for desks	ART.247	ART.241	ART.248	ART.242													
PROSPETTO INFORMATIVO information sheet																														
SCHIENA modesty panel	PER SCRIVANIE for desks																													
ART.247	ART.241																													
ART.248	ART.242																													
<table border="1"> <thead> <tr> <th>(*)</th> <th>PIANO</th> <th>STRUTTURA</th> <th>top</th> <th>structure</th> </tr> </thead> <tbody> <tr> <td>005</td> <td>ARGENTO GOLF</td> <td></td> <td>golf silver</td> <td></td> </tr> <tr> <td>440</td> <td>BIANCO BR.</td> <td></td> <td>br. white</td> <td></td> </tr> <tr> <td>844</td> <td>STONE GREY</td> <td></td> <td>stone grey</td> <td></td> </tr> </tbody> </table>											(*)	PIANO	STRUTTURA	top	structure	005	ARGENTO GOLF		golf silver		440	BIANCO BR.		br. white		844	STONE GREY		stone grey	
(*)	PIANO	STRUTTURA	top	structure																										
005	ARGENTO GOLF		golf silver																											
440	BIANCO BR.		br. white																											
844	STONE GREY		stone grey																											

PIANI sp. 25mm  
tops thick. 25mm

**BENCH PROF. CM 165,2 CON TOP ACCESS A RIBALTA**

bench depth 165,2 cms with top access tip-up door

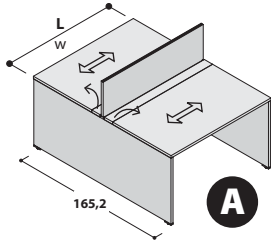
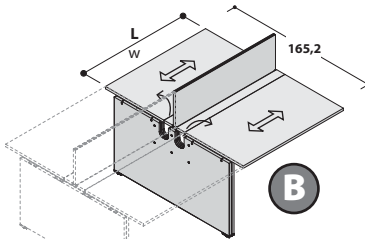
DESCRIZIONE description	L w	CODICE code	KG	M <sup>3</sup>	COLLI	PREZZO price	(*) CODICE FINITURA (*) finish code																																			
BENCH PROF. CM 165,2 (CON TOP ACCESS E VASCHEFFE PASSACAVI INTEGRATI) bench depth 165,2 cms (with top access and cable trays)  L. x p.165,2 x H.73,6-109,3	L.120	148 <b>260</b> (*)	92	0,214	7	€ 510,00	<table border="1"> <thead> <tr> <th>(*)</th> <th>PIANO</th> <th>STRUTTURA</th> <th>top</th> <th>structure</th> </tr> </thead> <tbody> <tr> <td>403</td> <td>ROVERE</td> <td>BIANCO BR.</td> <td>oak</td> <td>br. white</td> </tr> <tr> <td>440</td> <td>BIANCO BR.</td> <td>BIANCO BR.</td> <td>br. white</td> <td>br. white</td> </tr> <tr> <td>466</td> <td>NOCE PAVIA</td> <td>BIANCO BR.</td> <td>pavia walnut</td> <td>br. white</td> </tr> <tr> <td>803</td> <td>ROVERE</td> <td>STONE GREY</td> <td>oak</td> <td>stone grey</td> </tr> <tr> <td>844</td> <td>STONE GREY</td> <td>STONE GREY</td> <td>stone grey</td> <td>stone grey</td> </tr> <tr> <td>866</td> <td>NOCE PAVIA</td> <td>STONE GREY</td> <td>pavia walnut</td> <td>stone grey</td> </tr> </tbody> </table>	(*)	PIANO	STRUTTURA	top	structure	403	ROVERE	BIANCO BR.	oak	br. white	440	BIANCO BR.	BIANCO BR.	br. white	br. white	466	NOCE PAVIA	BIANCO BR.	pavia walnut	br. white	803	ROVERE	STONE GREY	oak	stone grey	844	STONE GREY	STONE GREY	stone grey	stone grey	866	NOCE PAVIA	STONE GREY	pavia walnut	stone grey
	(*)	PIANO	STRUTTURA	top	structure																																					
	403	ROVERE	BIANCO BR.	oak	br. white																																					
	440	BIANCO BR.	BIANCO BR.	br. white	br. white																																					
466	NOCE PAVIA	BIANCO BR.	pavia walnut	br. white																																						
803	ROVERE	STONE GREY	oak	stone grey																																						
844	STONE GREY	STONE GREY	stone grey	stone grey																																						
866	NOCE PAVIA	STONE GREY	pavia walnut	stone grey																																						
L.140	148 <b>261</b> (*)	101	0,233	7	€ 554,00																																					
L.160	148 <b>262</b> (*)	110	0,259	7	€ 618,00																																					
L.180	148 <b>263</b> (*)	118,5	0,270	7	€ 661,00																																					
BENCH PROF. CM 165,2 E FIANCHI INTERMEDI (CON TOP ACCESS E VASCHEFFE PASSACAVI INTEGRATI) bench depth 165,2 cms with central panels (with top access and cable trays)  L. x p.165,2 x H.73,6-109,3	L.120	148 <b>265</b> (*)	71	0,185	6	€ 474,00																																				
	L.140	148 <b>266</b> (*)	80	0,204	6	€ 518,00																																				
	L.160	148 <b>267</b> (*)	89	0,230	6	€ 582,00																																				
	L.180	148 <b>268</b> (*)	97,5	0,241	6	€ 625,00																																				

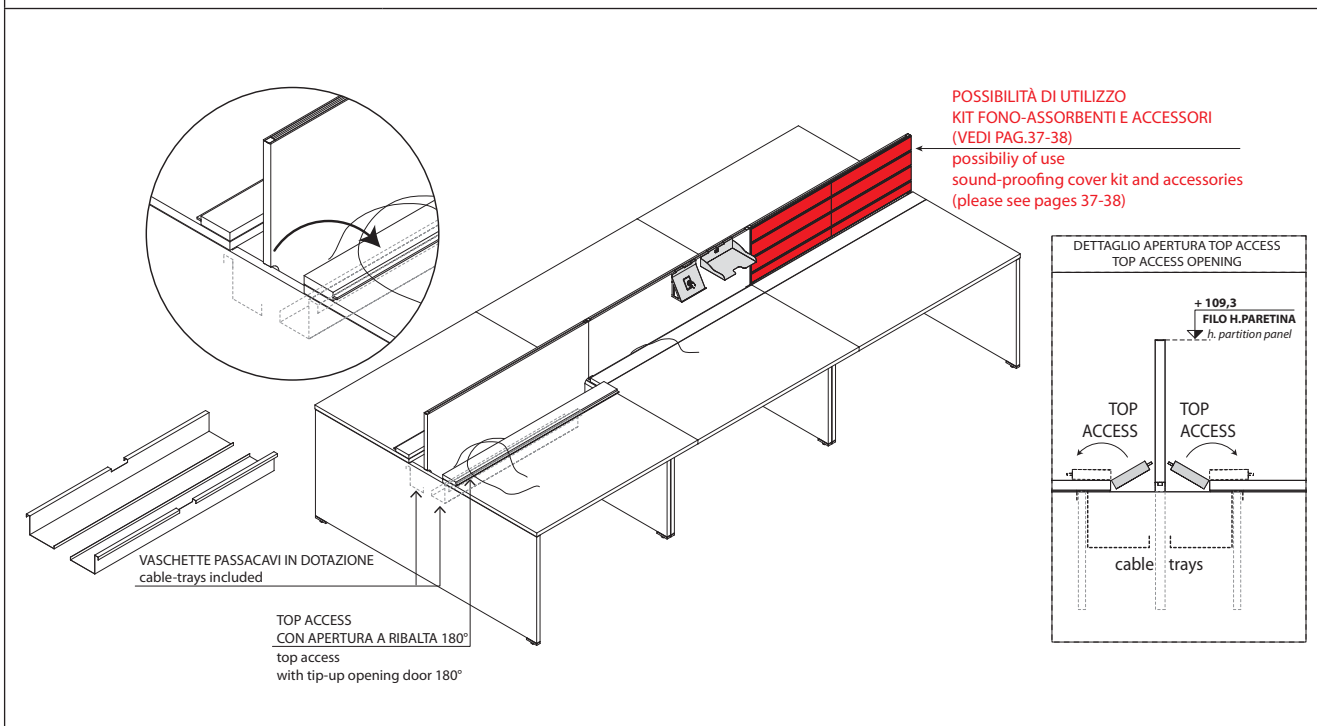
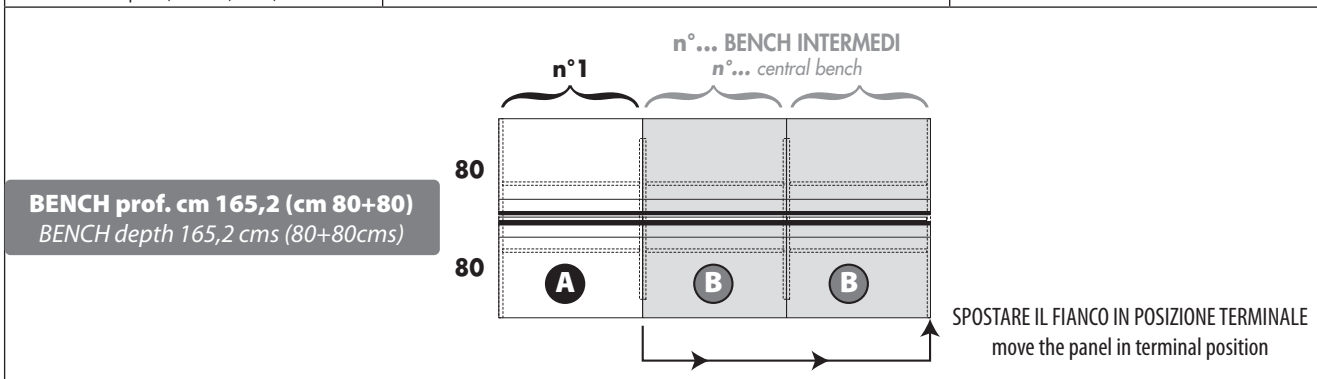

↔ = VENATURA LEGNO  
wood veining

**PIANI sp. 25mm**  
 tops thick. 25mm

**COMBY MONO-FACCIALI**  
*single-side COMBY*

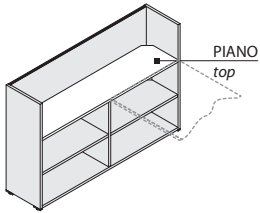
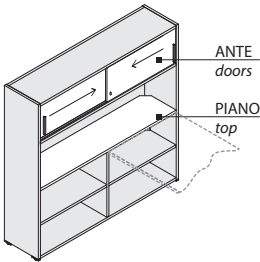
DESCRIZIONE <i>description</i>	L w	CODICE <i>code</i>	KG	M <sup>3</sup>	COLLI	PREZZO <i>price</i>	(*) CODICE FINITURA <i>(*) finish code</i>
COMBY MONO-FACCIALE H.109,3 (DOTATO DI 1 SALITA CAVI) <i>single-side comby h.43" (1 rising cable included)</i> 		<b>148 333 (*)</b>	80	0,217	7	<b>€ 295,00</b>	
L.165 x p.40 x H.109,3							
COMBY MONO-FACCIALE H.160 CON 2 ANTE SCORREVOLI CON SERRATURA (DOTATO DI 1 SALITA CAVI) <i>single-side comby h.160 cms (1 rising cable included)            with 2 sliding doors with lock</i> 		<b>148 334 (*)</b>	132	0,335	10	<b>€ 604,00</b>	
L.165 x p.40 x H.160							

(*)	PIANO e ANTE	STRUTTURA	top and doors	structure
403	ROVERE	BIANCO BR.	oak	br. white
440	BIANCO BR.	BIANCO BR.	br. white	br. white
466	NOCE PAVIA	BIANCO BR.	pavia walnut	br. white
803	ROVERE	STONE GREY	oak	stone grey
840	BIANCO BR.	STONE GREY	br. white	stone grey
844	STONE GREY	STONE GREY	stone grey	stone grey
866	NOCE PAVIA	STONE GREY	pavia walnut	stone grey

**COMBY BI-FACCIALI**  
*double-side COMBY*

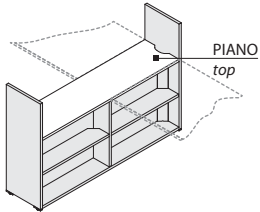
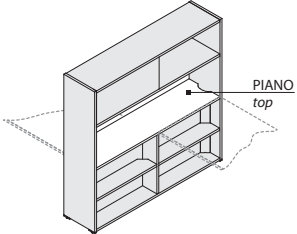
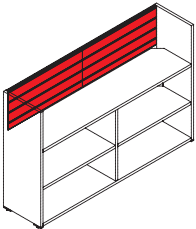
COMBY BI-FACCIALE H.109,3 (DOTATO DI 2 SALITE CAVI) <i>double-side comby h.43" (2 rising cable included)</i> 		<b>148 338 (*)</b>	72	0,187	9	<b>€ 294,00</b>	
L.165 x p.40 x H.109,3							
COMBY BI-FACCIALE H.160 (DOTATO DI 2 SALITE CAVI) <i>double-side comby h.160 cms (2 rising cable included)</i> 		<b>148 339 (*)</b>	110	0,278	11	<b>€ 442,00</b>	
L.165 x p.40 x H.160							
KIT FONOASSORBENTE PER 1 SOLO LATO <i>upholstered soundproofing cover kit for one side only</i> 		<b>148 905 (*)</b>	1,3	0,013	1	<b>€ 82,00</b>	
L.159,4 x sp.0,6 x H.35,3							



(*)	PIANO	STRUTTURA	top	structure
403	ROVERE	BIANCO BR.	oak	br. white
440	BIANCO BR.	BIANCO BR.	br. white	br. white
466	NOCE PAVIA	BIANCO BR.	pavia walnut	br. white
803	ROVERE	STONE GREY	oak	stone grey
840	BIANCO BR.	STONE GREY	br. white	stone grey
844	STONE GREY	STONE GREY	stone grey	stone grey
866	NOCE PAVIA	STONE GREY	pavia walnut	stone grey

(*)	TESSUTO POLIESTERE STRETCH IGNIFUGO	fire-retardant stretch polyester fabric
320	AZZURRO SKY	sky blue
321	GIALLO FRESIA	freesia yellow
322	AMARANTO	amaranth
323	VERDE BOSCO	wood green
328	TORTORA	grey beige



**PIANI sp. 25mm**  
 tops thick. 25mm

**CANALINE PER COMBY**
*cabl tray for comby*

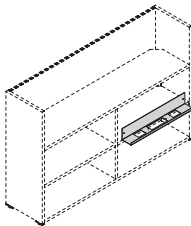
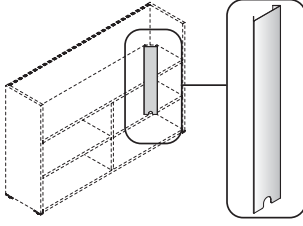
DESCRIZIONE <i>description</i>	L <i>w</i>	CODICE <i>code</i>	KG 	M <sup>3</sup> 	COLLI 	PREZZO <i>price</i>	(*) CODICE FINITURA <i>(*) finish code</i>
CANALINA ORIZZONTALE PER COMBY <i>horizontal cable-tray for comby</i>  L.64,5 x p.9,5 x H.10		148 310 (*)	4	0,024	1	€ 16,00	
SALITA CAVI SUPPLEMENTARE PER COMBY <i>additional rising cable tray for comby</i>  L.7 x p.7 x H.56,5		148 311 (*)	1	0,001	1	€ 12,00	

(*)		
440	BIANCO	white
844	STONE GREY	stone grey

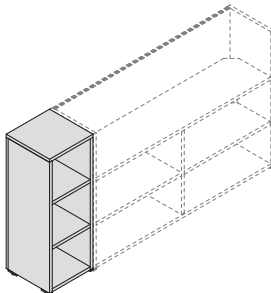
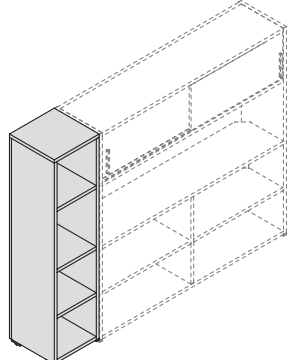

**LIBRERIE PER ESTENSIONE COMBY**
*bookcases for extension comby*

LIBRERIA H.109,3 <i>bookcase h.109,3 cms</i>  L.40 x p.40 x H.109,3		148 341 (*)	33	0,063	2	€ 120,00	
LIBRERIA H.160 <i>bookcase -</i>  L.40 x p.40 x H.160		148 342 (*)	38,3	0,079	3	€ 160,00	

(*)	STRUTTURA	structure
440	BIANCO BR.	br. white
844	STONE GREY	stone grey

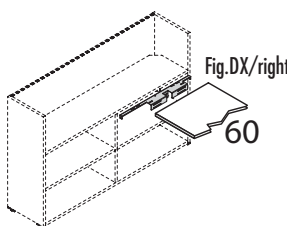

**STAFFE PER SCRIVANIE PROF. CM 60 SU COMBY***fixing stirrups for desks depth 60 cms on comby*

DESCRIZIONE <i>description</i>	L <i>w</i>	CODICE <i>code</i>	KG 	M <sup>3</sup> 	COLLI 	PREZZO <i>price</i>	(*) CODICE FINITURA <i>(*) finish code</i>			
STAFFA PER ATTACCO PIANI PROF. CM 60 A COMBY <i>fixing stirrup for desk top depth 60 cms with connection at comby</i>    L. x p.2 x H.7										
	DX <i>right</i>	L.60	148 312 (*)	2,5	0,012	1	€ 45,00	(*)		
	SX <i>left</i>	L.60	148 313 (*)					000	ARGENTO	<i>silver</i>
								440	BIANCO BR.	<i>br. white</i>
							844	STONE GREY	<i>stone grey</i>	

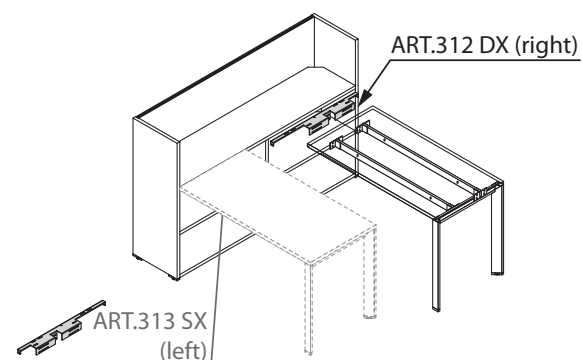
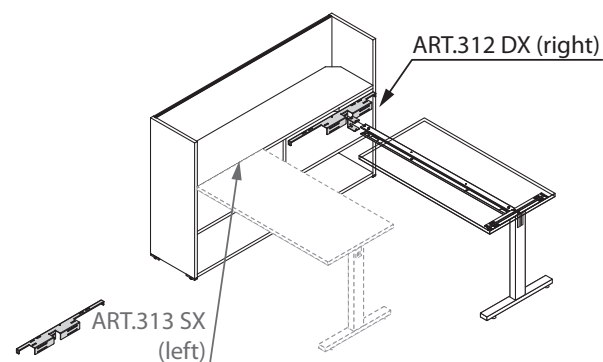
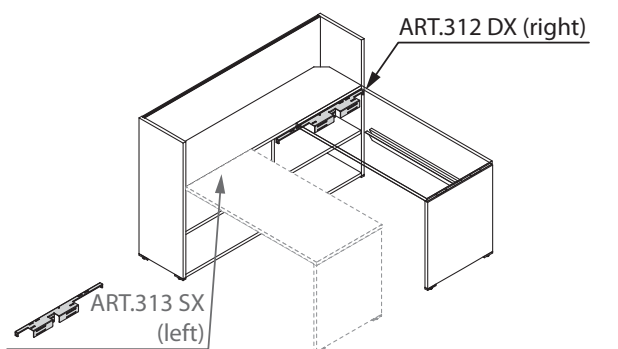
**ESEMPI DI UTILIZZO STAFFE ART.312 DX-313 SX SU SCRIVANIE PROF. CM 60***example of use stirrups art.312 (right) -313 (left) with desktops depth 60 cms*

**PIANI sp. 25mm**  
 tops thick. 25mm

**SCRIVANIE PER COMBY**  
 desks for COMBY

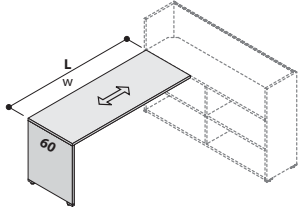
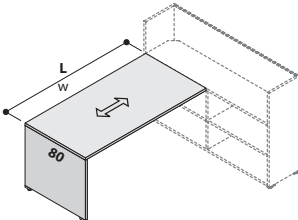
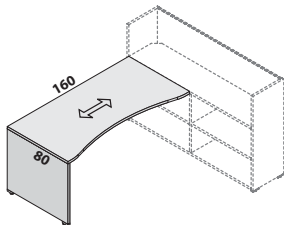
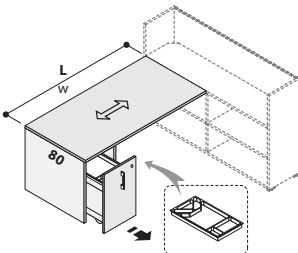
DESCRIZIONE description	L w	CODICE code	KG	M <sup>3</sup>	COLLI	PREZZO price	(*) CODICE FINITURA (*) finish code
SCRIVANIE PROF. CM 60 desks depth 60 cms    L. x p.60 x H.73,6	L.120	148 319 (*)	22,5	0,065	3	€ 116,00	
	L.140	148 320 (*)	24,5	0,070	3	€ 123,00	
	L.160	148 321 (*)	26,5	0,076	3	€ 128,00	
	L.180	148 322 (*)	28,5	0,082	3	€ 143,00	
	<b>COMPLETARE CON 1 STAFFA ART.312 DX O ART.313 SX</b> <b>(VEDI SCHEMA PAG.25)</b> <i>to be always complete with 1 stirrup art.312 (right) or 313 (left), please see page 25</i>						
SCRIVANIE PROF. CM 80 <b>(CON STAFFA FISSAGGIO A COMBY INCLUSA)</b> desks depth 80 cms <i>(with stirrup for fixing to comby included)</i>    L. x p.80 x H.73,6	L.120	148 323 (*)	31	0,099	4	€ 178,00	(*) PIANO FIANCO top side panel
	L.140	148 324 (*)	34	0,107	4	€ 188,00	403 ROVERE BIANCO BR. oak br. white
	L.160	148 325 (*)	37	0,116	4	€ 195,00	440 BIANCO BR. BIANCO BR. br. white br. white
	L.180	148 326 (*)	40	0,124	4	€ 203,00	466 NOCE PAVIA BIANCO BR. pavia walnut br. white
							803 ROVERE STONE GREY oak stone grey
SCRIVANIA SAGOMATA L.160 PROF. CM 80 <b>(CON STAFFA FISSAGGIO A COMBY INCLUSA)</b> shaped desk w 63" depth 80 cms <i>(with stirrup for fixing to comby included)</i>    L.160 x p.80 x H.73,6	L.160	148 327 (*)	37	0,109	4	€ 226,00	844 STONE GREY STONE GREY stone grey stone grey
							866 NOCE PAVIA STONE GREY pavia walnut stone grey
SCRIVANIE PROF. CM 80 <b>(CON STAFFA FISSAGGIO A COMBY INCLUSA)</b> desks depth 80 cms <i>(with stirrup for fixing to comby included)</i>    L. x p.80 x H.73,6	L.120	148 328 (*)	62,5	0,223	7	€ 552,00	(*) PIANO e FRONTALE STORAGE top and storage
	L.140	148 329 (*)	65,5	0,231	7	€ 562,00	403 ROVERE BIANCO BR. oak br. white
	L.160	148 330 (*)	68,5	0,239	7	€ 569,00	440 BIANCO BR. BIANCO BR. br. white br. white
	L.180	148 331 (*)	71,5	0,248	7	€ 577,00	466 NOCE PAVIA BIANCO BR. pavia walnut br. white
							803 ROVERE STONE GREY oak stone grey
						844 STONE GREY STONE GREY stone grey stone grey	
						866 NOCE PAVIA STONE GREY pavia walnut stone grey	

 ⇄ = VENATURA LEGNO  
 wood veining

**PIANI sp. 25mm**  
 tops thick. 25mm

**SCRIVANIE PER COMBY**  
 desks for COMBY

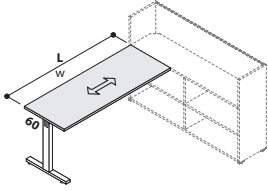
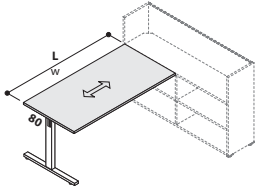
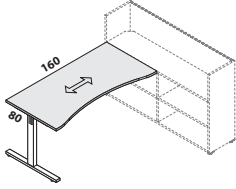
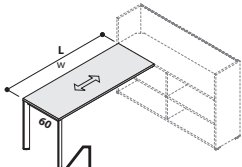
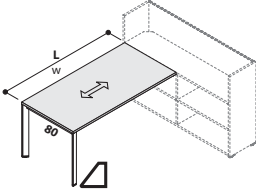
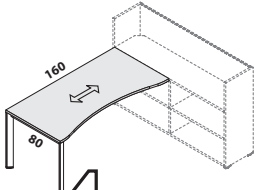
DESCRIZIONE description	L w	CODICE code	KG	M <sup>3</sup>	COLLI	PREZZO price	(*) CODICE FINITURA (*) finish code
SCRIVANIE PROF. CM 60 desks depth 60 cms  L. x p.60 x H.73,6	L.120	148 <b>353</b> (*)	21,5	0,089	4	€ 147,00	
	L.140	148 <b>354</b> (*)	23,8	0,096	4	€ 157,00	
	L.160	148 <b>355</b> (*)	26,2	0,104	4	€ 164,00	
	L.180	148 <b>356</b> (*)	28,5	0,111	4	€ 183,00	
	<b>COMPLETARE CON 1 STAFFA ART.312 DX O ART.313 SX</b> (VEDI SCHEMA PAG.25) <i>to be always complete with 1 stirrup art.312 (right) or 313 (left), please see page 25</i>						
SCRIVANIE PROF. CM 80 <b>(CON STAFFA FISSAGGIO A COMBY INCLUSA)</b> desks depth 80 cms (with stirrup for fixing to comby included)  L. x p.80 x H.73,6	L.120	148 <b>363</b> (*)	29	0,125	5	€ 205,00	(*) PIANO STRUTTURA top structure
	L.140	148 <b>364</b> (*)	29,8	0,122	5	€ 218,00	003 ROVERE ARGENTO oak silver
	L.160	148 <b>365</b> (*)	35,7	0,145	5	€ 227,00	040 BIANCO BR. ARGENTO br. white silver
	L.180	148 <b>366</b> (*)	39	0,155	5	€ 239,00	066 NOCE PAVIA ARGENTO pavia walnut silver
							403 ROVERE BIANCO oak white
							440 BIANCO BR. BIANCO br. white white
							466 NOCE PAVIA BIANCO pavia walnut white
							803 ROVERE STONE GREY oak stone grey
							844 STONE GREY STONE GREY stone grey stone grey
							866 NOCE PAVIA STONE GREY pavia walnut stone grey
SCRIVANIA SAGOMATA L.160 PROF. CM 80 <b>(CON STAFFA FISSAGGIO A COMBY INCLUSA)</b> shaped desk w 63° depth 80 cms (with stirrup for fixing to comby included)  L.160 x p.80 x H.73,6	L.160	148 <b>367</b> (*)	35,7	0,138	5	€ 258,00	
	<b>COMPLETARE CON 1 STAFFA ART.312 DX O ART.313 SX</b> (VEDI SCHEMA PAG.25) <i>to be always complete with 1 stirrup art.312 (right) or 313 (left), please see page 25</i>						
SCRIVANIE PROF. CM 60 desks depth 60 cms  L. x p.60 x H.73,6	L.120	148 <b>372</b> (*)	24,5	0,088	3	€ 184,00	
	L.140	148 <b>373</b> (*)	27,1	0,097	3	€ 197,00	
	L.160	148 <b>374</b> (*)	29,1	0,106	3	€ 205,00	
	L.180	148 <b>375</b> (*)	32,5	0,112	3	€ 222,00	
	<b>COMPLETARE CON 1 STAFFA ART.312 DX O ART.313 SX</b> (VEDI SCHEMA PAG.25) <i>to be always complete with 1 stirrup art.312 (right) or 313 (left), please see page 25</i>						
SCRIVANIE PROF. CM 80 <b>(CON STAFFA FISSAGGIO A COMBY INCLUSA)</b> desks depth 80 cms (with stirrup for fixing to comby included)  L. x p.80 x H.73,6	L.120	148 <b>377</b> (*)	31,5	0,130	4	€ 244,00	(*) PIANO STRUTTURA top structure
	L.140	148 <b>378</b> (*)	35,1	0,142	4	€ 260,00	003 ROVERE ARGENTO oak silver
	L.160	148 <b>379</b> (*)	38,1	0,154	4	€ 270,00	040 BIANCO BR. ARGENTO br. white silver
	L.180	148 <b>380</b> (*)	42,5	0,162	4	€ 280,00	066 NOCE PAVIA ARGENTO pavia walnut silver
							403 ROVERE BIANCO oak white
							440 BIANCO BR. BIANCO br. white white
							466 NOCE PAVIA BIANCO pavia walnut white
							803 ROVERE STONE GREY oak stone grey
							844 STONE GREY STONE GREY stone grey stone grey
							866 NOCE PAVIA STONE GREY pavia walnut stone grey
SCRIVANIA SAGOMATA L.160 PROF. CM 80 <b>(CON STAFFA FISSAGGIO A COMBY INCLUSA)</b> shaped desk w 63° depth 80 cms (with stirrup for fixing to comby included)  L.160 x p.80 x H.73,6	L.160	148 <b>381</b> (*)	38,1	0,147	4	€ 301,00	
	<b>COMPLETARE CON 1 STAFFA ART.312 DX O ART.313 SX</b> (VEDI SCHEMA PAG.25) <i>to be always complete with 1 stirrup art.312 (right) or 313 (left), please see page 25</i>						

**BENCH PROF. CM 125,2 PER COMBY**

bench depth 125,2 cms for COMBY

PIANI sp. 25mm  
tops thick. 25mm

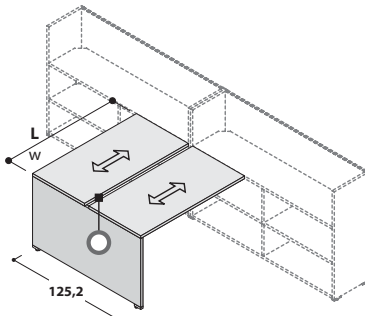
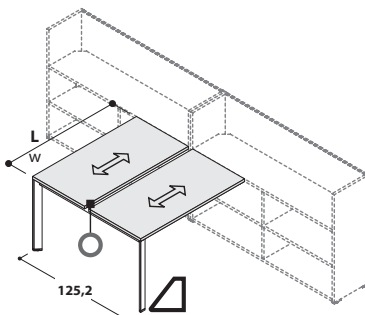
DESCRIZIONE description	L w	CODICE code	KG	M <sup>3</sup>	COLLI	PREZZO price	(*) CODICE FINITURA (*) finish code				
BENCH PROF. CM 125,2 (CON STAFFE FISSAGGIO A COMBY INCLUDE) bench depth 125,2 cms (with stirrups for fixing to comby included)  <p>L. x p.125,2 x H.73,6</p>	L.120	148 404 (*)	51	0,142	7	€ 322,00	(*)	PIANO	FIANCO	top	side panel
	L.140	148 405 (*)	55	0,153	7	€ 336,00	403	ROVERE	BIANCO BR.	oak	br. white
	L.160	148 406 (*)	59	0,165	7	€ 346,00	440	BIANCO BR.	BIANCO BR.	br. white	br. white
	L.180	148 407 (*)	63	0,176	7	€ 376,00	466	NOCE PAVIA	BIANCO BR.	pavia walnut	br. white
							803	ROVERE	STONE GREY	oak	stone grey
BENCH PROF. CM 125,2 (CON STAFFE FISSAGGIO A COMBY INCLUDE) bench depth 125,2 cms (with stirrups for fixing to comby included)  <p>L. x p.125,2 x H.73,6</p>	L.120	148 384 (*)	49	0,204	7	€ 396,00	(*)	PIANO	STRUTTURA	top	structure
	L.140	148 385 (*)	54,2	0,223	7	€ 422,00	003	ROVERE	ARGENTO	oak	silver
	L.160	148 386 (*)	58,2	0,241	7	€ 438,00	040	BIANCO BR.	ARGENTO	br. white	silver
	L.180	148 387 (*)	65	0,252	7	€ 472,00	066	NOCE PAVIA	ARGENTO	pavia walnut	silver
							403	ROVERE	BIANCO	oak	white
							440	BIANCO BR.	BIANCO	br. white	white
							466	NOCE PAVIA	BIANCO	pavia walnut	white
							803	ROVERE	STONE GREY	oak	stone grey
							844	STONE GREY	STONE GREY	stone grey	stone grey
							866	NOCE PAVIA	STONE GREY	pavia walnut	stone grey

**BENCH PROF. CM 165,2 PER COMBY**

bench depth 165,2 cms for COMBY

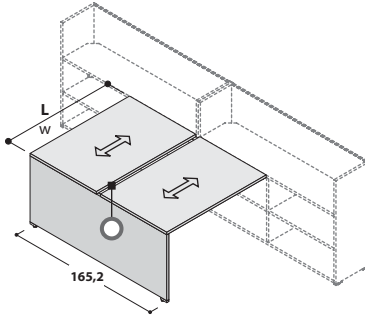
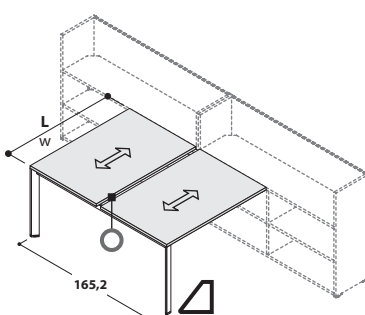
BENCH PROF. CM 165,2 (CON STAFFE FISSAGGIO A COMBY INCLUDE) bench depth 165,2 cms (with stirrups for fixing to comby included)  <p>L. x p.165,2 x H.73,6</p>	L.120	148 408 (*)	62	0,177	7	€ 359,00	(*)	PIANO	FIANCO	top	side panel
	L.140	148 409 (*)	68	0,194	7	€ 379,00	403	ROVERE	BIANCO BR.	oak	br. white
	L.160	148 410 (*)	74	0,211	7	€ 393,00	440	BIANCO BR.	BIANCO BR.	br. white	br. white
	L.180	148 411 (*)	80	0,227	7	€ 409,00	466	NOCE PAVIA	BIANCO BR.	pavia walnut	br. white
							803	ROVERE	STONE GREY	oak	stone grey
BENCH PROF. CM 165,2 (CON STAFFE FISSAGGIO A COMBY INCLUDE) bench depth 165,2 cms (with stirrups for fixing to comby included)  <p>L. x p.165,2 x H.73,6</p>	L.120	148 390 (*)	58	0,258	7	€ 427,00	(*)	PIANO	STRUTTURA	top	structure
	L.140	148 391 (*)	65,2	0,282	7	€ 459,00	003	ROVERE	ARGENTO	oak	silver
	L.160	148 392 (*)	71,2	0,306	7	€ 479,00	040	BIANCO BR.	ARGENTO	br. white	silver
	L.180	148 393 (*)	80	0,322	7	€ 499,00	066	NOCE PAVIA	ARGENTO	pavia walnut	silver
							403	ROVERE	BIANCO	oak	white
							440	BIANCO BR.	BIANCO	br. white	white
							466	NOCE PAVIA	BIANCO	pavia walnut	white
							803	ROVERE	STONE GREY	oak	stone grey
							844	STONE GREY	STONE GREY	stone grey	stone grey
							866	NOCE PAVIA	STONE GREY	pavia walnut	stone grey

**SCHEMA DI UTILIZZO BASAMENTI METALLICI**  
*basement use scheme*

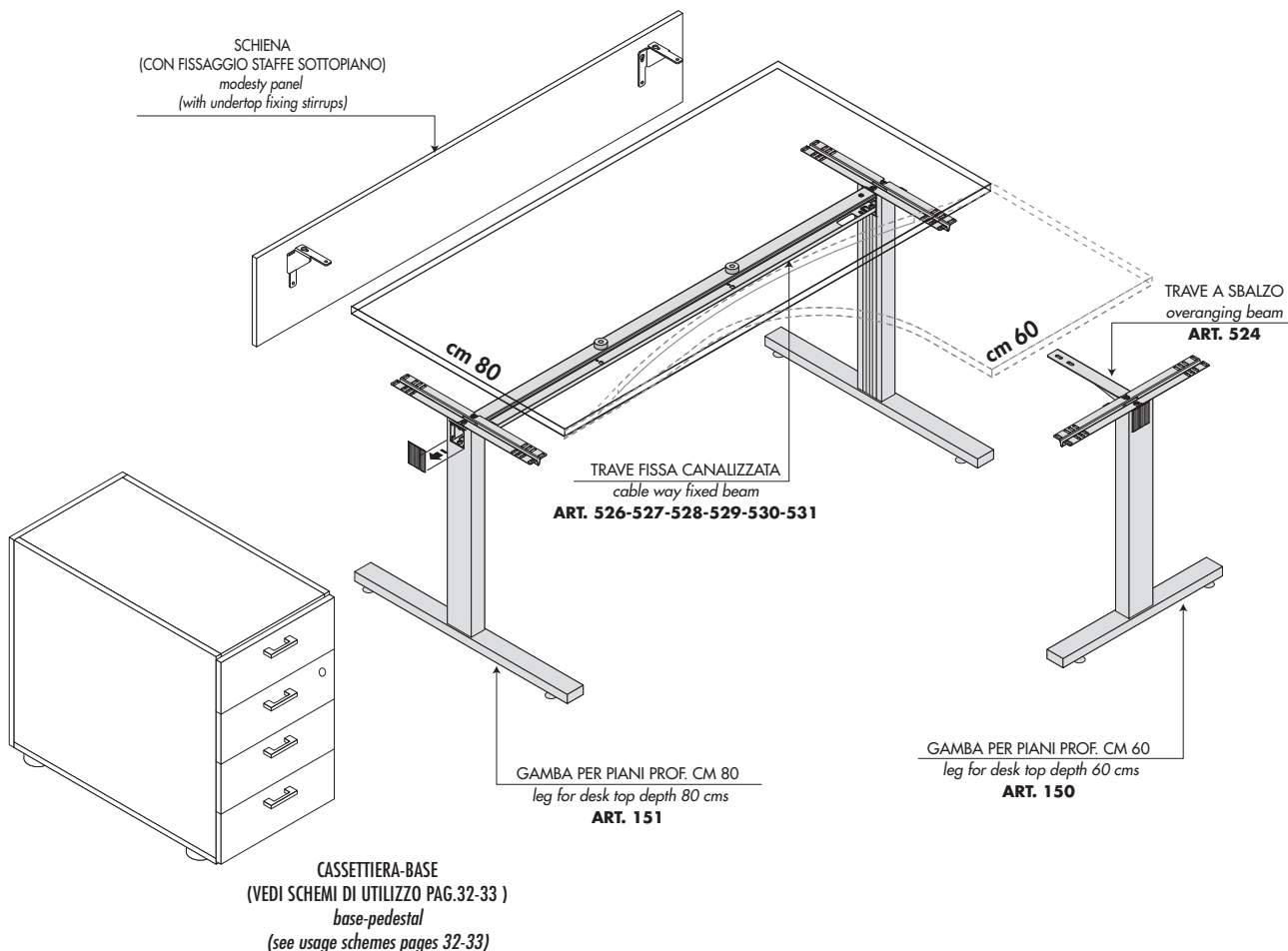

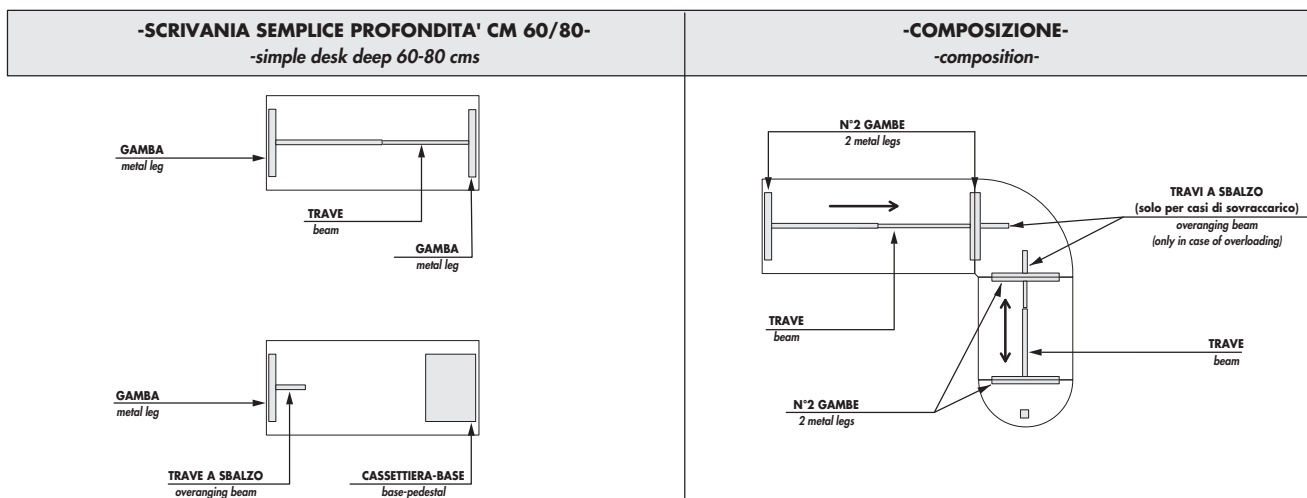

**TUTTE LE GAMBE METALLICHE POSSONO ESSERE POSTE IN POSIZIONE CENTRALE**  
*all the metallic legs may be placed in central position*





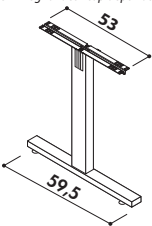
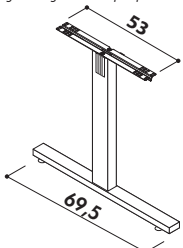

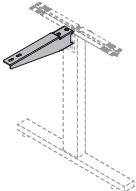
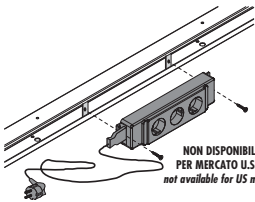
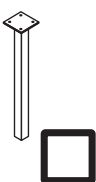
## SOSTEGNI SOTTOPIANO PER SCRIVANIE

undertop stirrups for desks

DESCRIZIONE description	L w	CODICE code	KG	M <sup>3</sup>	COLLI	PREZZO price	(*) CODICE FINITURA (*) finish code												
GAMBA SINGOLA A "T" PER PIANI PROF. CM 60 single "T" leg for desk top depth 60 cms  H.71,1		148 150 (*)	6	0,041	1	€ 66,00													
GAMBA SINGOLA A "T" PER PIANI PROF. CM 80 single "T" leg for desk top depth 80 cms  H.71,1		148 151 (*)	7	0,048	1	€ 67,00													
TRAVI CANALIZZATE PER SCRIVANIE E WORKSTATION cable-way beams for desks and workstation 		<b>PER PIANI for desktops</b>																	
	L.80	148 526 (*)	1,2	0,006	1	€ 21,00													
	L.100	148 527 (*)	1,5	0,009	1	€ 23,00													
	L.120	148 528 (*)	2	0,010	1	€ 26,00													
	L.140	148 529 (*)	2,3	0,012	1	€ 29,00													
	L.160	148 530 (*)	2,7	0,014	1	€ 31,00													
	L.180	148 531 (*)	3	0,016	1	€ 35,00													
TRAVE A SBALZO PER SCRIVANIE, PENISOLE, ALLUNGHI E ANGOLI DI RACCORDO overanging beam for desks, terminals, extensions and joining segments  L.32		148 524 (*)	1	0,001	1	€ 17,00													
KIT 2 PIASTRINI+ KIT ELETTRIFICAZIONE SINGOLO CON PRESE SCHUKO E CAVO DI ALIMENTAZIONE DI MT. 2,00 kit with 2 plates+single electrification kit with SCHUKO sockets and power cable w 2 lmt.  NON DISPONIBILE PER MERCATO U.S.A. not available for US market		148 525 (*)	1	0,006	1	€ 91,00													
GAMBA QUADRATA squared leg  H.71,1		148 129 (*)	3	0,009	1	€ 37,00													
							<table border="1"> <thead> <tr> <th>(*)</th> <th>GAMBA</th> <th>leg</th> </tr> </thead> <tbody> <tr> <td>000</td> <td>ARGENTO</td> <td>silver</td> </tr> <tr> <td>440</td> <td>BIANCO BR.</td> <td>br. white</td> </tr> <tr> <td>844</td> <td>STONE GREY</td> <td>stone grey</td> </tr> </tbody> </table>	(*)	GAMBA	leg	000	ARGENTO	silver	440	BIANCO BR.	br. white	844	STONE GREY	stone grey
(*)	GAMBA	leg																	
000	ARGENTO	silver																	
440	BIANCO BR.	br. white																	
844	STONE GREY	stone grey																	
							<table border="1"> <thead> <tr> <th>(*)</th> <th>TRAVI</th> <th>beams</th> </tr> </thead> <tbody> <tr> <td>000</td> <td>ARGENTO</td> <td>silver</td> </tr> <tr> <td>440</td> <td>BIANCO BR.</td> <td>br. white</td> </tr> <tr> <td>844</td> <td>STONE GREY</td> <td>stone grey</td> </tr> </tbody> </table>	(*)	TRAVI	beams	000	ARGENTO	silver	440	BIANCO BR.	br. white	844	STONE GREY	stone grey
(*)	TRAVI	beams																	
000	ARGENTO	silver																	
440	BIANCO BR.	br. white																	
844	STONE GREY	stone grey																	
							<table border="1"> <thead> <tr> <th>(*)</th> <th>KIT PIASTRINI</th> <th>plates kit</th> </tr> </thead> <tbody> <tr> <td>000</td> <td>ARGENTO</td> <td>silver</td> </tr> </tbody> </table> KIT PRESE e CAVO: COLORE NERO sockets kit and cable: black color	(*)	KIT PIASTRINI	plates kit	000	ARGENTO	silver						
(*)	KIT PIASTRINI	plates kit																	
000	ARGENTO	silver																	

# ELEMENTI COMUNI\_SHARED ELEMENTS

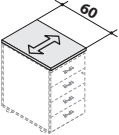
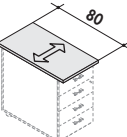
CASSETTIERE-BASI O LATERALI PER SCRIVANIE base or lateral pedestals for desks																																																														
DESCRIZIONE description	L w	CODICE code	KG	M <sup>3</sup>	COLLI	PREZZO price	(*) CODICE FINITURA (* finish code)																																																							
CASSETTIERA-BASE O LATERALE CON 4 CASSETTI CON SERRATURA <b>(PER PIANI PROF. CM 60)</b> base or lateral pedestal with 4 drawers with lock (for tops depth 60 cms)  L.41,7 x p.59,4 x H.71		<table border="1"> <tr> <th>CASSETTI IN LEGNO wooden drawers</th> <th>CON CHIUSURA AMMORTIZZATA with soft-close</th> </tr> <tr> <td>148 <b>396</b> (*)</td> <td>32   0,210   1</td> </tr> </table>	CASSETTI IN LEGNO wooden drawers	CON CHIUSURA AMMORTIZZATA with soft-close	148 <b>396</b> (*)	32   0,210   1				€ 209,00																																																				
	CASSETTI IN LEGNO wooden drawers	CON CHIUSURA AMMORTIZZATA with soft-close																																																												
148 <b>396</b> (*)	32   0,210   1																																																													
CASSETTIERA-BASE O LATERALE CON 1 CASSETTO CLASSIFICATORE CON SERRATURA <b>(PER PIANI PROF. CM 60)</b> base or lateral pedestal with 1 file-drawer with lock (for tops depth 60 cms)  L.41,7 x p.59,4 x H.71		<table border="1"> <tr> <th>CASSETTI IN LEGNO wooden drawers</th> <th>CON CHIUSURA AMMORTIZZATA with soft-close</th> </tr> <tr> <td>148 <b>397</b> (*)</td> <td>27   0,232   1</td> </tr> </table>	CASSETTI IN LEGNO wooden drawers	CON CHIUSURA AMMORTIZZATA with soft-close	148 <b>397</b> (*)	27   0,232   1				€ 225,00																																																				
	CASSETTI IN LEGNO wooden drawers	CON CHIUSURA AMMORTIZZATA with soft-close																																																												
148 <b>397</b> (*)	27   0,232   1																																																													
							<table border="1"> <tr> <th colspan="3">VERSIONE MONO-COLORE / single-color version</th> </tr> <tr> <th>(*)</th> <th></th> <th></th> </tr> <tr> <td>166</td> <td>NOCE PAVIA</td> <td>pavia walnut</td> </tr> <tr> <td>440</td> <td>BIANCO BR.</td> <td>br. white</td> </tr> <tr> <td>844</td> <td>STONE GREY</td> <td>stone grey</td> </tr> </table> <table border="1"> <tr> <th colspan="4">VERSIONE BI-COLORE / double-color version</th> </tr> <tr> <th>(*)</th> <th>FRONTALI</th> <th>STRUTTURA</th> <th>fronts structure</th> </tr> <tr> <td>003</td> <td>ROVERE</td> <td>ARGENTO GOLF</td> <td>oak golf silver</td> </tr> <tr> <td>025</td> <td>GRIGIO</td> <td>ARGENTO GOLF</td> <td>grey golf silver</td> </tr> <tr> <td>040</td> <td>BIANCO BR.</td> <td>ARGENTO GOLF</td> <td>br. white golf silver</td> </tr> <tr> <td>066</td> <td>NOCE PAVIA</td> <td>ARGENTO GOLF</td> <td>pavia walnut golf silver</td> </tr> <tr> <td>403</td> <td>ROVERE</td> <td>BIANCO BR.</td> <td>oak br. white</td> </tr> <tr> <td>466</td> <td>NOCE PAVIA</td> <td>BIANCO BR.</td> <td>pavia walnut br. white</td> </tr> <tr> <td>803</td> <td>ROVERE</td> <td>STONE GREY</td> <td>oak stone grey</td> </tr> <tr> <td>866</td> <td>NOCE PAVIA</td> <td>STONE GREY</td> <td>pavia walnut stone grey</td> </tr> </table>	VERSIONE MONO-COLORE / single-color version			(*)			166	NOCE PAVIA	pavia walnut	440	BIANCO BR.	br. white	844	STONE GREY	stone grey	VERSIONE BI-COLORE / double-color version				(*)	FRONTALI	STRUTTURA	fronts structure	003	ROVERE	ARGENTO GOLF	oak golf silver	025	GRIGIO	ARGENTO GOLF	grey golf silver	040	BIANCO BR.	ARGENTO GOLF	br. white golf silver	066	NOCE PAVIA	ARGENTO GOLF	pavia walnut golf silver	403	ROVERE	BIANCO BR.	oak br. white	466	NOCE PAVIA	BIANCO BR.	pavia walnut br. white	803	ROVERE	STONE GREY	oak stone grey	866	NOCE PAVIA	STONE GREY	pavia walnut stone grey
VERSIONE MONO-COLORE / single-color version																																																														
(*)																																																														
166	NOCE PAVIA	pavia walnut																																																												
440	BIANCO BR.	br. white																																																												
844	STONE GREY	stone grey																																																												
VERSIONE BI-COLORE / double-color version																																																														
(*)	FRONTALI	STRUTTURA	fronts structure																																																											
003	ROVERE	ARGENTO GOLF	oak golf silver																																																											
025	GRIGIO	ARGENTO GOLF	grey golf silver																																																											
040	BIANCO BR.	ARGENTO GOLF	br. white golf silver																																																											
066	NOCE PAVIA	ARGENTO GOLF	pavia walnut golf silver																																																											
403	ROVERE	BIANCO BR.	oak br. white																																																											
466	NOCE PAVIA	BIANCO BR.	pavia walnut br. white																																																											
803	ROVERE	STONE GREY	oak stone grey																																																											
866	NOCE PAVIA	STONE GREY	pavia walnut stone grey																																																											
CASSETTIERA-BASE O LATERALE CON 4 CASSETTI CON SERRATURA <b>(PER PIANI PROF. CM 80)</b> base or lateral pedestal with 4 drawers with lock (for tops depth 80 cms)  L.41,7 x p.77,6 x H.71		<table border="1"> <tr> <th>CASSETTI IN LEGNO wooden drawers</th> <th>CON CHIUSURA AMMORTIZZATA with soft-close</th> </tr> <tr> <td>148 <b>398</b> (*)</td> <td>36   0,210   1</td> </tr> </table>	CASSETTI IN LEGNO wooden drawers	CON CHIUSURA AMMORTIZZATA with soft-close	148 <b>398</b> (*)	36   0,210   1				€ 233,00																																																				
	CASSETTI IN LEGNO wooden drawers	CON CHIUSURA AMMORTIZZATA with soft-close																																																												
148 <b>398</b> (*)	36   0,210   1																																																													
CASSETTIERA-BASE O LATERALE CON 1 CASSETTO CLASSIFICATORE CON SERRATURA <b>(PER PIANI PROF. CM 80)</b> base or lateral pedestal with 1 file-drawer with lock (for tops depth 80 cms)  L.41,7 x p.77,6 x H.71		<table border="1"> <tr> <th>CASSETTI IN LEGNO wooden drawers</th> <th>CON CHIUSURA AMMORTIZZATA with soft-close</th> </tr> <tr> <td>148 <b>399</b> (*)</td> <td>31   0,232   1</td> </tr> </table>	CASSETTI IN LEGNO wooden drawers	CON CHIUSURA AMMORTIZZATA with soft-close	148 <b>399</b> (*)	31   0,232   1				€ 249,00																																																				
	CASSETTI IN LEGNO wooden drawers	CON CHIUSURA AMMORTIZZATA with soft-close																																																												
148 <b>399</b> (*)	31   0,232   1																																																													
TOP PER CASSETTIERA LATERALE PROF. CM 60 finishing top for lateral pedestal depth 60 cms  L.42 x p.60 x H.2,5		<table border="1"> <tr> <th>PIANO sp. 25mm top thick. 25mm</th> </tr> <tr> <td>148 <b>401</b> (*)</td> </tr> </table>	PIANO sp. 25mm top thick. 25mm	148 <b>401</b> (*)				€ 21,00																																																						
	PIANO sp. 25mm top thick. 25mm																																																													
148 <b>401</b> (*)																																																														
							<table border="1"> <tr> <th>(*)</th> <th>PIANO</th> <th>top</th> </tr> <tr> <td>166</td> <td>NOCE PAVIA</td> <td>pavia walnut</td> </tr> <tr> <td>200</td> <td>GRIGIO</td> <td>grey</td> </tr> <tr> <td>440</td> <td>BIANCO BR.</td> <td>br. white</td> </tr> <tr> <td>733</td> <td>ROVERE</td> <td>oak</td> </tr> <tr> <td>844</td> <td>STONE GREY</td> <td>stone grey</td> </tr> </table>	(*)	PIANO	top	166	NOCE PAVIA	pavia walnut	200	GRIGIO	grey	440	BIANCO BR.	br. white	733	ROVERE	oak	844	STONE GREY	stone grey																																					
(*)	PIANO	top																																																												
166	NOCE PAVIA	pavia walnut																																																												
200	GRIGIO	grey																																																												
440	BIANCO BR.	br. white																																																												
733	ROVERE	oak																																																												
844	STONE GREY	stone grey																																																												
TOP PER CASSETTIERA LATERALE PROF. CM 80 finishing top for lateral pedestal depth 80 cms  L.42 x p.80 x H.2,5		<table border="1"> <tr> <th>PIANO sp. 25mm top thick. 25mm</th> </tr> <tr> <td>148 <b>402</b> (*)</td> </tr> </table>	PIANO sp. 25mm top thick. 25mm	148 <b>402</b> (*)				€ 28,00																																																						
	PIANO sp. 25mm top thick. 25mm																																																													
148 <b>402</b> (*)																																																														

**SCHEMA DI UTILIZZO  
CARTELLE SU CLASSIFICATORI  
scheme for using folders in file-cabinets**

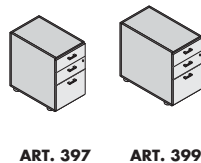

POS.	TIPO DI CARTELLA type of folder	INTERASSE CENTER DISTANCE (cm)
A	GRANDE EUROPA big Europe	cm 39
B	PICCOLA EUROPA little Europe	cm 33
C	GRANDE U.S.A. big U.S.A.	cm 38,5
D	PICCOLA U.S.A. little U.S.A.	cm 31
E	GRANDE CILE big Chile	cm 37,2

! = CON DOTAZIONE STANDARD ARCHIVIAZIONE EUROPEA  
= European filing by standard outfit



↔ = VENATURA LEGNO  
wood veining



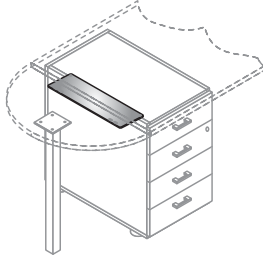

STAFFA PER CASSETTIERA-BASE stirrup for base pedestals							
DESCRIZIONE description	L w	CODICE code	KG	M <sup>3</sup>	COLLI	PREZZO price	(*) CODICE FINITURA (*) finish code
STAFFA PER COLLEGAMENTO CASSETTIERA-BASE A PENISOLE O ANGOLO DI RACCORDO stirrup for connection base-pedestal to terminal or joining segments    L.47 x p.12,5 x H.0,15		148 467 (*)	1	0,004	1	€ 15,00	
							(*)
							000 ARGENTO silver
							440 BIANCO white
							844 STONE GREY stone grey

**SCHEMA DI UTILIZZO STAFFA ART.467**  
scheme of using stirrup art.467

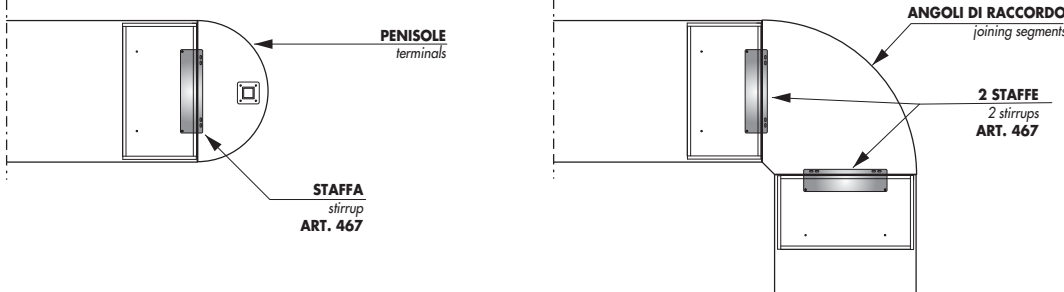
**ATTENZIONE!**  
SUL LATO ADIACENTE ALLE PENISOLE O ANGOLI DI RACCORDO  
LA CASSETTIERA-BASE DEVE ESSERE COMPLETATA CON STAFFA ART. 467  
*Attention!*  
on the side adjoining peninsulas or extensions the base-pedestal must be completed with a stirrup art. 467

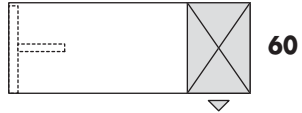

**SCHEMA DI UTILIZZO CASSETTIERE-BASI**  
scheme for using the base-pedestals

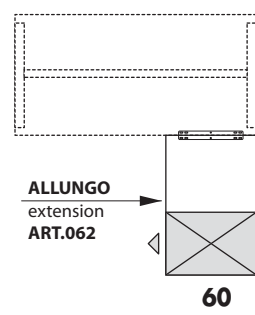
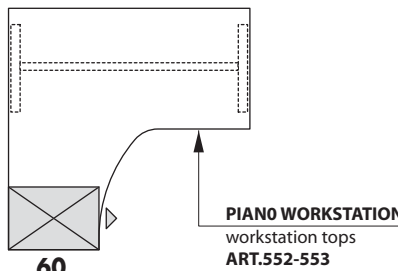
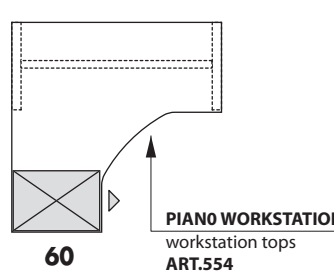
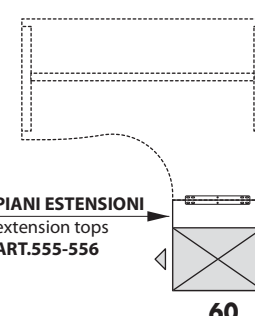
A CON GAMBA METALLICA + TRAVE A SBALZO with metal legs - overranging beam	A CON GAMBA METALLICA + TRAVE A SBALZO with metal legs - overranging beam	
 <b>60</b>  PIANI SCRIVANIE PROF. CM 60 desk tops depth 23¾" cms ART.544-545-546-547-548	 <b>80</b>  PIANI SCRIVANIE PROF. CM 80 desk tops depth 31½" cms ART.534-535-536-537-538	 <b>60</b>  ALLUNGO extension ART.062
B CON BASAMENTO METALLICO with metal base	B CON BASAMENTO METALLICO with metal base	
 <b>60</b>  PIANO WORKSTATION workstation tops ART.552-553  <b>ESEMPIO CON RIDUZIONE A SX</b> example with left reduction	 <b>60</b>  PIANO WORKSTATION workstation tops ART.554	 <b>60</b>  PIANI ESTENSIONI extension tops ART.555-556

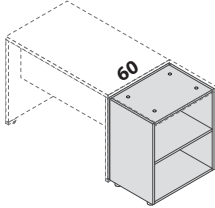
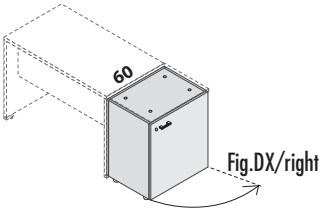
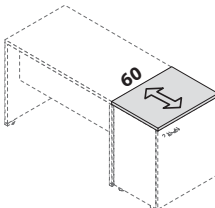
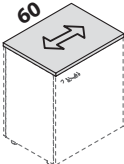
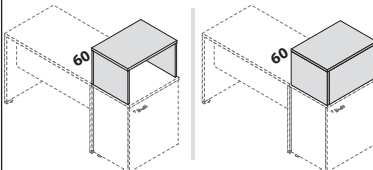
MOBILI LATERALI PER SCRIVANIE E WORKSTATION PROF. CM 60								
side cabinets for desks and workstation depth 60 cms								
DESCRIZIONE description	L w	CODICE code	KG	M <sup>3</sup>	COLLI	PREZZO price	(*) CODICE FINITURA (*) finish code	
MOBILE LATERALE A GIORNO PER SCRIVANIA <i>lateral open cabinet for desk</i>    L.60 x p.44,2 x H.71	L.60	148 <b>666</b> (*)	20	0,041	2	€ 87,00	(*)	
	<b>COMPLETARE SEMPRE CON TOP / always complete with top</b> ART.672-676						005	ARGENTO GOLF golf silver
							166	NOCE PAVIA pavia walnut
						440	BIANCO BR. br. white	
						844	STONE GREY stone grey	
MOBILE LATERALE PER SCRIVANIA CON SERRATURA <i>side cabinet for desk with lock</i>   Fig.DX/right  L.60 x p.46,2 x H.71	VERSIONE MONO-COLORE / <i>single-color version</i>							
							(*)	
							166	NOCE PAVIA pavia walnut
						440	BIANCO BR. br. white	
						844	STONE GREY stone grey	
							VERSIONE BI-COLORE / <i>double-color version</i>	
						(*)	ANTA STRUTTURA door structure	
						003	ROVERE ARGENTO GOLF oak golf silver	
						025	GRIGIO ARGENTO GOLF grey golf silver	
						040	BIANCO BR. ARGENTO GOLF br. white golf silver	
						066	NOCE PAVIA ARGENTO GOLF pavia walnut golf silver	
						403	ROVERE BIANCO BR. oak br. white	
						466	NOCE PAVIA BIANCO BR. pavia walnut br. white	
						803	ROVERE STONE GREY oak stone grey	
						866	NOCE PAVIA STONE GREY pavia walnut stone grey	
TOP PER MOBILE LATERALE CON VENATURA TRASVERSALE <i>top for side cabinet for desk with transversal wood veining</i>    L.60 x p.46,2 x H.2,5	PIANO sp. mm 25 top thick. 25mm		CON VENATURA TRASVERSALE transversal wood veining					
	L.60	148 <b>672</b> (*)	5	0,008	1	€ 28,00	(*)	
							PIANO	top
						166	NOCE PAVIA pavia walnut	
						200	GRIGIO grey	
						440	BIANCO BR. br. white	
						733	ROVERE oak	
						844	STONE GREY stone grey	
TOP PER MOBILE LATERALE (FREESTANDING) <i>top for side cabinet for desk (freestanding)</i>    L.60 x p.46,2 x H.2,5	PIANO sp. mm 25 top thick. 25mm							
	L.60	148 <b>676</b> (*)	5	0,009	1	€ 28,00	(*)	
SOPRALZO PER MOBILE LATERALE <i>upper element for side cabinet</i>  IL MONTAGGIO DEL SOPRALZO E' REVERSIBILE <i>the assembling of the upper element is reversible</i>    L.x p.44,2 x H.38	L.60	148 <b>678</b> (*)	9	0,023	1	€ 46,00	(*)	
							005	ARGENTO GOLF golf silver
							166	NOCE PAVIA pavia walnut
						200	GRIGIO grey	
						440	BIANCO BR. br. white	
						733	ROVERE oak	
						844	STONE GREY stone grey	

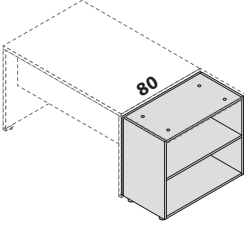
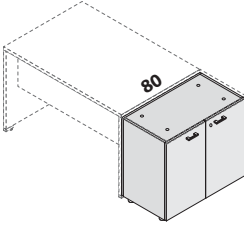
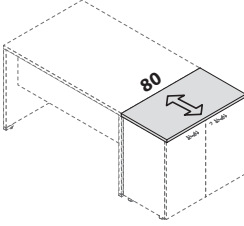
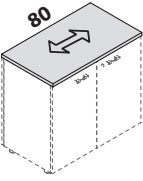
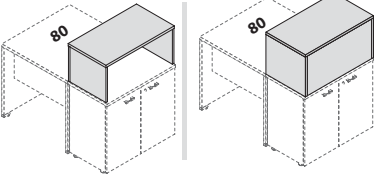
MOBILI LATERALI PER SCRIVANIE E WORKSTATION PROF. CM 80								
side cabinets for desks and workstation depth 80 cms								
DESCRIZIONE description	L w	CODICE code	KG	M <sup>3</sup>	COLLI	PREZZO price	(*) CODICE FINITURA (*) finish code	
MOBILE LATERALE A GIORNO PER SCRIVANIA <i>lateral open cabinet for desk</i>    L.80 x p.44,2 x H.71	L.80	148 669 (*)	24	0,051	2	€ 100,00	(*)	
	COMPLETARE SEMPRE CON TOP / always complete with top ART.673-677						005	ARGENTO GOLF golf silver
							166	NOCE PAVIA pavia walnut
						440	BIANCO BR. br. white	
						844	STONE GREY stone grey	
MOBILE LATERALE PER SCRIVANIA CON SERRATURA <i>side cabinet for desk with lock</i>    L.80 x p.46,2 x H.71	L.80	148 671 (*)	35	0,084	3	€ 161,00	(*)	
	COMPLETARE SEMPRE CON TOP / always complete with top ART.673-677						VERSIONE MONO-COLORE / single-color version	
							166	NOCE PAVIA pavia walnut
						440	BIANCO BR. br. white	
						844	STONE GREY stone grey	
						VERSIONE BI-COLORE / double-color version		
						003	ROVERE ARGENTO GOLF oak golf silver	
						025	GRIGIO ARGENTO GOLF grey golf silver	
						040	BIANCO BR. ARGENTO GOLF br. white golf silver	
						066	NOCE PAVIA ARGENTO GOLF pavia walnut golf silver	
						403	ROVERE BIANCO BR. oak br. white	
						466	NOCE PAVIA BIANCO BR. pavia walnut br. white	
						803	ROVERE STONE GREY oak stone grey	
						866	NOCE PAVIA STONE GREY pavia walnut stone grey	
TOP PER MOBILE LATERALE CON VENATURA TRASVERSALE <i>top for side cabinet for desk with transversal wood veining</i>    L.80 x p.46,2 x H.2,5	PIANO sp. mm 25 top thick. 25mm		CON VENATURA TRASVERSALE transversal wood veining				(*)	
	L.80	148 673 (*)	10	0,019	1	€ 31,00	PIANO top	
						166	NOCE PAVIA pavia walnut	
						200	GRIGIO grey	
TOP PER MOBILE LATERALE (FREESTANDING) <i>top for side cabinet for desk (freestanding)</i>    L.80 x p.46,2 x H.2,5	PIANO sp. mm 25 top thick. 25mm						(*)	
	L.80	148 677 (*)	10	0,019	1	€ 31,00	PIANO top	
						440	BIANCO BR. br. white	
						733	ROVERE oak	
						844	STONE GREY stone grey	
SOPRALZO PER MOBILE LATERALE <i>upper element for side cabinet</i>  IL MONTAGGIO DEL SOPRALZO E' REVERSIBILE <i>the assembling of the upper element is reversible</i>    L.80 x p.44,2 x H.38	L.80	148 679 (*)	12	0,030	1	€ 55,00	(*)	
							005	ARGENTO GOLF golf silver
							166	NOCE PAVIA pavia walnut
						200	GRIGIO grey	
						440	BIANCO BR. br. white	
						733	ROVERE oak	
						844	STONE GREY stone grey	

**PANNELLI FRONTALI PER BENCH**

front panels for bench

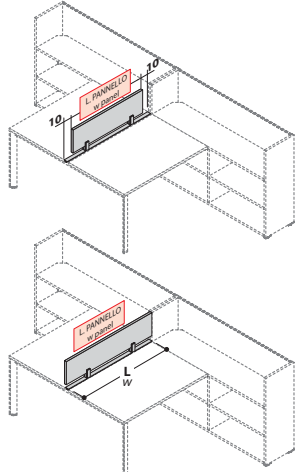
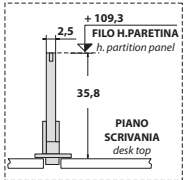
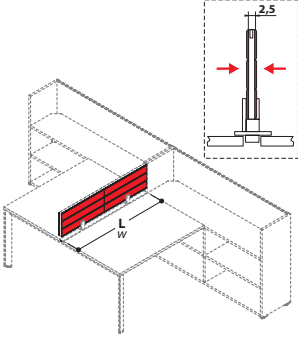
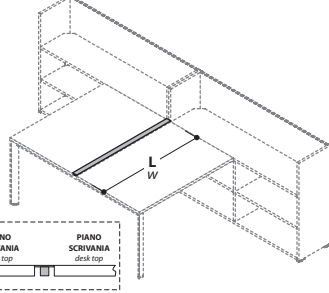
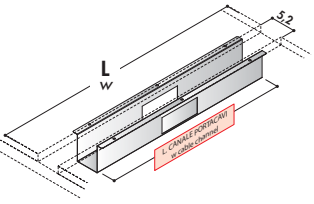
DESCRIZIONE description	L w	L w	CODICE code	KG	M <sup>3</sup>	COLLI	PREZZO price	(*) CODICE FINITURA (*) finish code	
PANNELLI FRONTALI PER BENCH (CON COPERTURA CENTRALE PASSACAVI) front panels for bench (with cable ways central covers)   <p>L. x p.2,5 x H.36</p>									
			<b>L. PANNELLO w panel</b>	<b>UTILIZZARE SU PIANI use for desktop</b>	<b>MELAMINICO melamine</b>				
	L100	L120	148 <b>255</b> (*)	9,5	0,028	3	€ 86,00	(*) PANNELLO, MORSETTI E COPERTURA panel, clamps and cover	
	L120	L120-140	148 <b>256</b> (*)	10,5	0,035	3	€ 97,00	000 ARGENTO silver	
	L140	L140-160	148 <b>257</b> (*)	12,5	0,040	3	€ 105,00	440 BIANCO BR. br. white	
	L160	L160-180	148 <b>258</b> (*)	13,5	0,048	3	€ 113,00	844 STONE GREY stone grey	
	L180	148 <b>259</b> (*)	15	0,051	3	€ 124,00			
KIT FONO-ASSORBENTE BIFACCIALE sound-proofing fabric cover for double sides  <p>L. x p.0,6+ 0,6 x H.28,7</p>									
					<b>TESSUTO fabric</b>				
	L100		148 <b>909</b> (*)	1,3	0,010	1	€ 111,00	(*) TESSUTO POLIESTERE STRETCH IGNIFUGO fire-retardant stretch polyester fabric	
	L120		148 <b>910</b> (*)	1,6	0,010	1	€ 122,00	320 AZZURRO SKY sky blue	
	L140		148 <b>911</b> (*)	2,1	0,013	1	€ 142,00	321 GIALLO FRESIA freesia yellow	
	L160		148 <b>912</b> (*)	2,1	0,013	1	€ 158,00	322 AMARANTO amaranth	
	L180	148 <b>913</b> (*)	2,3	0,013	1	€ 181,00	323 VERDE BOSCO wood green		
							328 TORTORA grey beige		
COPERTURE CENTRALI PASSACAVI PER BENCH cable ways central covers for bench  <p>PIANO SCRIVANIA desk top</p>									
	L120		148 <b>209</b> (*)	1	0,006	1	€ 35,00	(*)	
	L140		148 <b>210</b> (*)	1	0,008	1	€ 37,00	000 ARGENTO silver	
	L160		148 <b>211</b> (*)	2	0,008	1	€ 39,00	440 BIANCO BR. br. white	
	L180		148 <b>212</b> (*)	2	0,012	1	€ 42,00	844 STONE GREY stone grey	
CANALI PORTACAVI IN LAMIERA METALLICA PER BENCH cable channels in metal sheet for bench  <p>L. x p.5,2</p>									
			<b>L. PORTACAVI w cable channel</b>	<b>UTILIZZARE SU PIANI use for desktop</b>					
	L70	L120	148 <b>347</b> (*)	1	0,016	1	€ 39,00		
	L90	L140	148 <b>348</b> (*)	1	0,016	1	€ 48,00		
	L110	L160	148 <b>349</b> (*)	1	0,022	1	€ 55,00		
	L180	148 <b>350</b> (*)	1	0,022	1	€ 63,00			



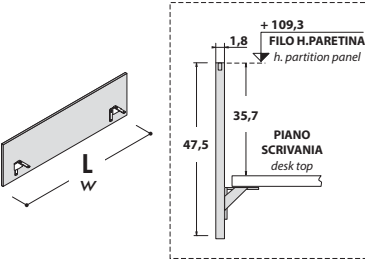

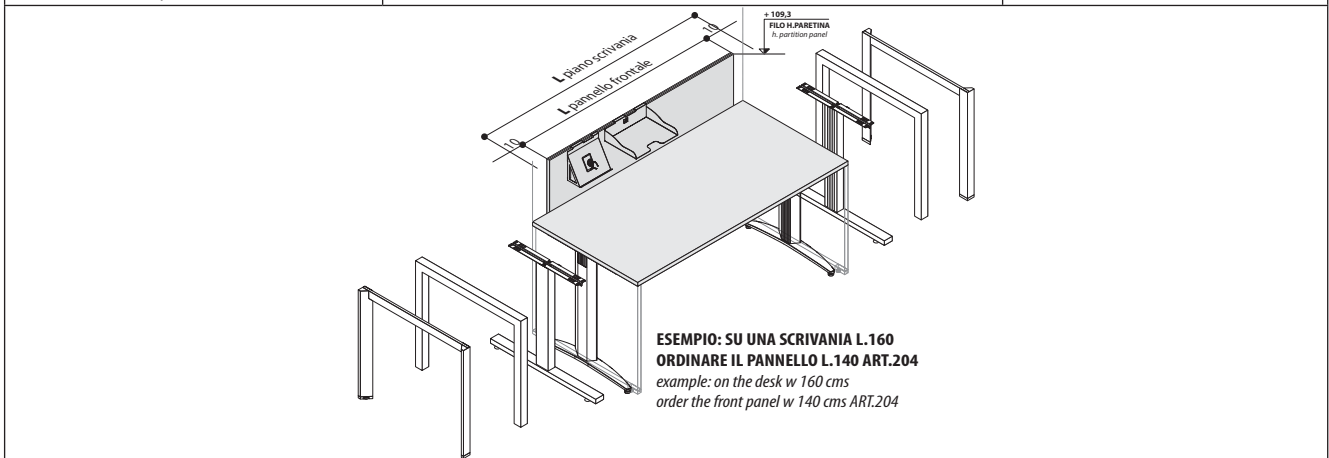

**PANNELLI FRONTALI PER SCRIVANIE**  
front panels for desks

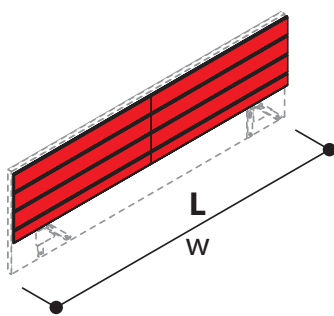
DESCRIZIONE description	L w	L w	CODICE code	KG	M <sup>3</sup>	COLLI	PREZZO price	(*) CODICE FINITURA (*) finish code	
PANNELLI FRONTALI front panels  	<b>L. PANNELLO</b> w front panel		<b>UTILIZZARE SU PIANI</b> use for desktop						
	L60	L80	148 <b>200</b> (*)	4	0,014	2	€ 38,00	(*)	
	L80	L100	148 <b>201</b> (*)	5	0,018	2	€ 44,00	005 ARGENTO GOLF golf silver	
	L100	L120	148 <b>202</b> (*)	7	0,020	2	€ 50,00	440 BIANCO BR. br. white	
	L120	L140	148 <b>203</b> (*)	9	0,025	2	€ 55,00	844 STONE GREY stone grey	
	L140	L160	148 <b>204</b> (*)	10	0,029	2	€ 61,00		
	L160	L180	148 <b>205</b> (*)	12	0,032	2	€ 68,00		
	L. x p.1,8 x H.47,5								

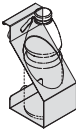

**KIT RIVESTIMENTO PER PANNELLI FRONTALI SCRIVANIE**  
upholstered sound-proofing cover kit for front panel for desks

DESCRIZIONE description	L w	L w	CODICE code	KG	M <sup>3</sup>	COLLI	PREZZO price	(*) CODICE FINITURA (*) finish code	
KIT RIVESTIMENTO FONO-ASSORBENTE PER 1 SOLO LATO upholstered sound-proofing cover kit for one side only  	<b>L. PANNELLO</b> w front panel		<b>UTILIZZARE SU PIANI</b> use for desktop						
	L60	L80	148 <b>900</b> (*)	0,5	0,007	1	€ 34,00	(*)	
	L80	L100	148 <b>901</b> (*)	0,7	0,009	1	€ 43,00	320 AZZURRO SKY sky blue	
	L100	L120	148 <b>902</b> (*)	0,8	0,010	1	€ 58,00	321 GIALLO FRESIA freesia yellow	
	L120	L140	148 <b>903</b> (*)	0,9	0,010	1	€ 64,00	322 AMARANTO amaranth	
	L140	L160	148 <b>904</b> (*)	1	0,013	1	€ 75,00	323 VERDE BOSCO wood green	
	L160	L180	148 <b>905</b> (*)	1,3	0,013	1	€ 82,00	328 TORTORA grey beige	
	L180	L180	148 <b>906</b> (*)	1,3	0,013	1	€ 93,00		
	L. x p.0,6 x H.35,3								

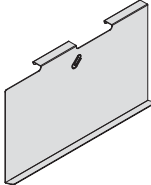
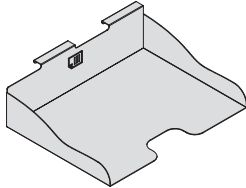
ACCESSORI PER PANNELLI FRONTALI																			
accessories for front panels																			
DESCRIZIONE description	L w	CODICE code	KG	M <sup>3</sup>	COLLI	PREZZO price	(*) CODICE FINITURA (*) finish code												
<p>1 GANCIO 1 hook</p>  <p>L.2,5 x p.3,3 x H.13,4</p>		148 927 (*)	0,3	0,002	1	€ 24,00													
<p>PORTA-FIORE CON PROVETTA flower-holder with tube</p>  <p>L.4 x p.10 x H.13,4</p>		148 928 (*)	0,3	0,002	1	€ 29,00													
<p>PORTA-BOTTIGLIA bottle-holder</p>  <p>L.8 x p.10 x H.17,6</p>		148 929 (*)	0,3	0,002	1	€ 28,00													
<p>PORTA-PENNE pen-holder</p>  <p>L.8,2 x p.8 x H.11</p>		148 930 (*)	0,3	0,002	1	€ 28,00													
<p>PORTA-CELLULARE smartphone-holder</p>  <p>L.16,4 x p.9 x H.13,4</p>		148 931 (*)	0,3	0,002	1	€ 30,00	<table border="1"> <tr> <td>(*)</td> <td></td> <td></td> </tr> <tr> <td>000</td> <td>ARGENTO</td> <td>silver</td> </tr> <tr> <td>440</td> <td>BIANCO</td> <td>white</td> </tr> <tr> <td>844</td> <td>STONE GREY</td> <td>stone grey</td> </tr> </table>	(*)			000	ARGENTO	silver	440	BIANCO	white	844	STONE GREY	stone grey
(*)																			
000	ARGENTO	silver																	
440	BIANCO	white																	
844	STONE GREY	stone grey																	
<p>PORTA-TABLET tablet-holder</p>  <p>L.25 x p.13,2 x H.20,6</p>		148 932 (*)	0,7	0,025	1	€ 35,00													
<p>LAVAGNA METALLICA metallic board</p>  <p>L.33 x p.3,7 x H.19,3</p>		148 933 (*)	0,7	0,025	1	€ 35,00													
<p>PORTA-CARTA A4 A4 paper-holder</p>  <p>L.33,2 x p.26,9 x H.9</p>		148 934 (*)	1,2	0,025	1	€ 35,00													

**SCHIENE PER SCRIVANIE CON BASAMENTI METALLICI**

*modesty panels for desks with metal base*

DESCRIZIONE <i>description</i>	L <i>w</i>	L <i>w</i>	CODICE <i>code</i>	KG 	M <sup>3</sup> 	COLLI 	PREZZO <i>price</i>	(*) CODICE FINITURA <i>(*) finish code</i>								
SCHIENE PER SCRIVANIE O WORKSTATION <i>modesty panel for desks or workstation</i>    L.x p.1,8 x H.30	<b>L. SCHIENA</b> <i>w modesty</i>		<b>UTILIZZARE SU PIANI</b> <i>use for desktop</i>													
	L60	L80	148 <b>685</b> (*)	4	0,011	2	€ 29,00	(*)								
	L80	L100	148 <b>686</b> (*)	4,5	0,011	2	€ 32,00	005								
	L100	L120	148 <b>687</b> (*)	4,5	0,011	2	€ 35,00	440								
	L120	L140	148 <b>688</b> (*)	5,2	0,012	2	€ 39,00	844								
	L140	L160	148 <b>689</b> (*)	6,2	0,017	2	€ 42,00									
	L160	L180	148 <b>690</b> (*)	7	0,022	2	€ 45,00									
									<table border="1"> <thead> <tr> <th>PANNELLO</th> <th><i>panel</i></th> </tr> </thead> <tbody> <tr> <td>ARGENTO GOLF</td> <td><i>golf silver</i></td> </tr> <tr> <td>BIANCO BR.</td> <td><i>br. white</i></td> </tr> <tr> <td>STONE GREY</td> <td><i>stone grey</i></td> </tr> </tbody> </table>	PANNELLO	<i>panel</i>	ARGENTO GOLF	<i>golf silver</i>	BIANCO BR.	<i>br. white</i>	STONE GREY
PANNELLO	<i>panel</i>															
ARGENTO GOLF	<i>golf silver</i>															
BIANCO BR.	<i>br. white</i>															
STONE GREY	<i>stone grey</i>															

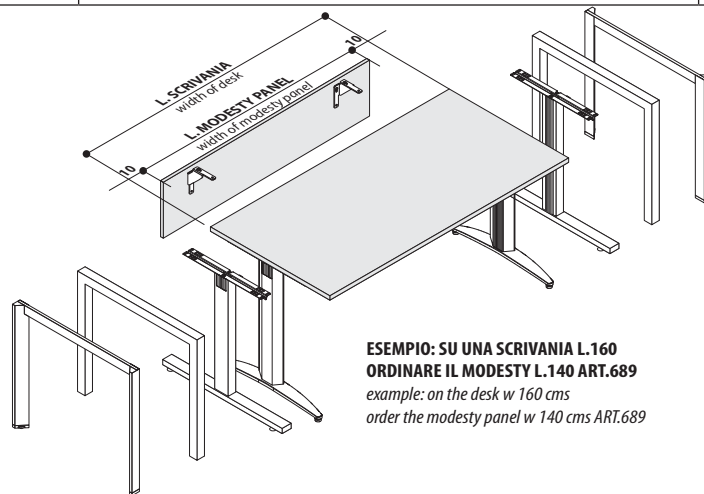

**SCHEMA DI UTILIZZO PANNELLO FRONTALE INSIEME A SCHIENA**

*scheme of use front panel together with modesty panels*

**POSSIBILITA' DI UTILIZZO DI PANNELLO FRONTALE+SCHIENA**  
*use of front panel together with modesty panel*

SUPPORTI SOTTOPIANO <i>undertop supports</i>	PIANI PROF. CM 60 <i>tops deep 60 cms</i>	PIANI PROF. CM 80 <i>tops deep 80 cms</i>
	✓	✓
	---	✓

PIANI sp. 25mm  
tops thick. 25mm

**PIANI SCRIVANIE PROF. CM 60**

desk tops depth 60 cms

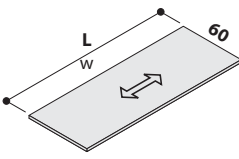
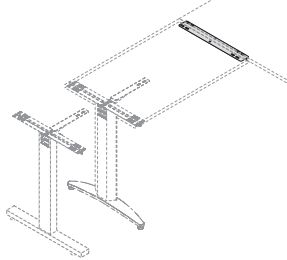
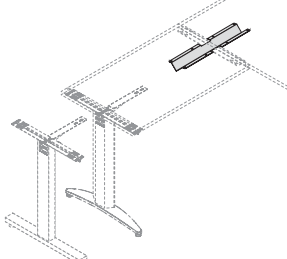
DESCRIZIONE description	L w	CODICE code	KG	M <sup>3</sup>	COLLI	PREZZO price	(*) CODICE FINITURA (*) finish code
PIANI SCRIVANIE PROF. CM 60 desk tops depth 60 cms    L. x p.60 x H.2,5	L.80	148 543 (*)	9	0,024	1	€ 33,00	
	△ L.100	148 544 (*)	11	0,030	1	€ 42,00	
	L.120	148 545 (*)	13	0,036	1	€ 47,00	(*) PIANO top
	L.140	148 546 (*)	15	0,041	1	€ 54,00	166 NOCE PAVIA pavia walnut
	L.160	148 547 (*)	17	0,047	1	€ 59,00	200 GRIGIO grey
	L.180	148 548 (*)	19	0,053	1	€ 74,00	440 BIANCO BR. br. white
							733 ROVERE oak
△ IN CASO DI UTILIZZO COME ALLUNGO LATERALE DA COMPLETARE SEMPRE CON 1 STAFFA ART.498 incase of utilization as lateral extension always complete with 1 stirrup art.498							
STAFFA PER ALLUNGO LATERALE ART.544 stirrup for lateral extension art.544    L.42 x p.5,5 x H.0,3		148 498 (*)	2	0,002	1	€ 16,00	(*) ARGENTO silver
							000 ARGENTO silver
STAFFA DI RINFORZO SOTTOPIANO PER ALLUNGO LATERALE ART.544 undertop stirrup for lateral extension art.544    L.48 x p.9 x H.3,2		148 659 (*)	1	0,004	1	€ 23,00	440 BIANCO white
							844 STONE GREY stone grey

**SCHEMA DI UTILIZZO PIANO ALLUNGO LATERALE ART.544**

scheme of utilization the lateral extension art.544

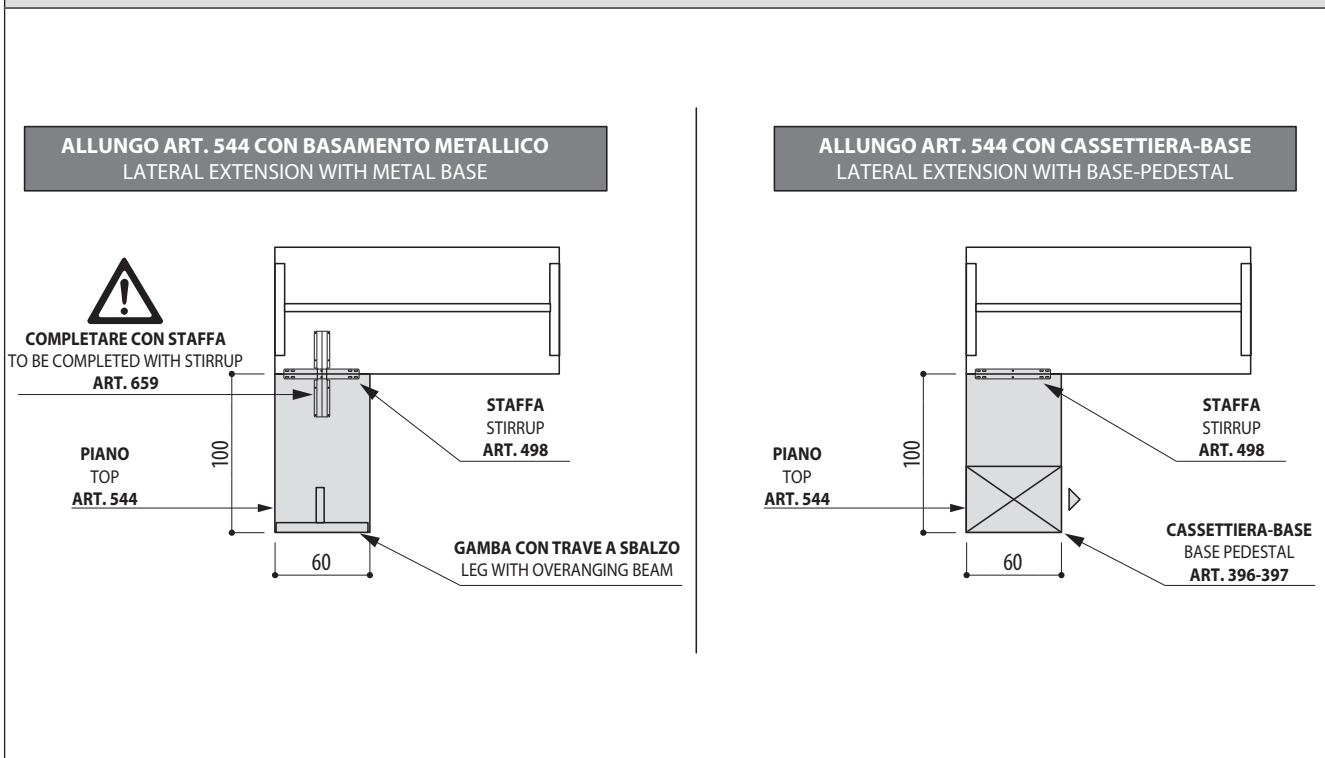

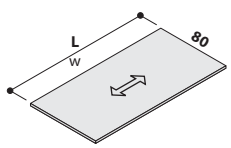
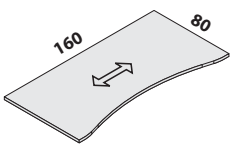
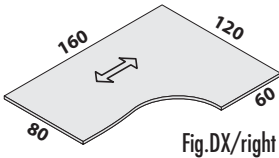
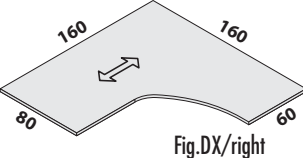
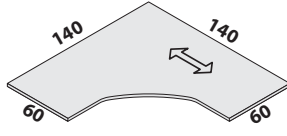

**PIANI SCRIVANIE PROF. CM 80 E WORKSTATION**  
*desk tops depth 80 cms and workstation*

DESCRIZIONE <i>description</i>	L w	CODICE code	KG	M <sup>3</sup>	COLLI	PREZZO price	(*) CODICE FINITURA (*) finish code
<b>PIANI SCRIVANIE PROF. CM 80</b> <i>desk tops depth 80 cms</i>   L. x p.80 x H.2,5	L.80	148 <b>533</b> (*)	11	0,035	1	€ 40,00	
	L.100	148 <b>534</b> (*)	14	0,044	1	€ 48,00	
	L.120	148 <b>535</b> (*)	17	0,052	1	€ 57,00	
	L.140	148 <b>536</b> (*)	20	0,060	1	€ 67,00	
	L.160	148 <b>537</b> (*)	23	0,069	1	€ 74,00	
	L.180	148 <b>538</b> (*)	26	0,077	1	€ 82,00	
<b>PIANO SCRIVANIA SAGOMATA L.160</b> <i>shaped desk top w 63"</i>   L.160 x p.80 x H.2,5	L.160	148 <b>549</b> (*)	23	0,062	1	€ 105,00	
<b>PIANO WORKSTATION L.160x120 CON RIDUZIONE</b> <i>workstation top w 63"x47¼" with reduction</i>   Fig.DX/right L.160 x p.120 x H.2,5	DX right L.160	148 <b>550</b> (*)	27	0,100	1	€ 127,00	(*) PIANO top
	SX left L.160	148 <b>551</b> (*)					166 NOCE PAVIA pavia walnut
<b>PIANO WORKSTATION L.160x160 CON RIDUZIONE</b> <i>workstation top w 63"x63" with reduction</i>   Fig.DX/right L.160 x p.160/80-60 x H.2,5	DX right L.160	148 <b>552</b> (*)	42	0,154	1	€ 215,00	200 GRIGIO grey
	SX left L.160	148 <b>553</b> (*)					440 BIANCO BR. br. white
<b>PIANO WORKSTATION SIMMETRICA L.140x140 CON LATI PROF. CM 60</b> <i>symmetrical workstation top w 55¼"x55¼" with deep sides 23¼"</i>   L.140 x p.140/60 x H.2,5	L.140	148 <b>554</b> (*)	32	0,118	1	€ 133,00	733 ROVERE oak
							844 STONE GREY stone grey

**ESTENSIONI CON VENATURA TRASVERSALE**  
*extensions with transversal wood veining*

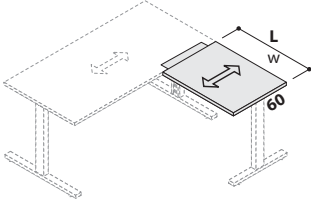
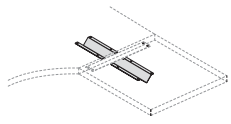
<b>ESTENSIONI CON VENATURA TRASVERSALE E STAFFA</b> <i>extensions with transversal veinig and stirrup</i>   L.x p.60 x H.2,5	L.60	148 <b>555</b> (*)	10	0,022	2	€ 53,00	(*) PIANO top
	L.80	148 <b>556</b> (*)	11	0,026	2	€ 59,00	166 NOCE PAVIA pavia walnut
<b>STAFFA DI RINFORZO SOTTOPIANO PER ESTENSIONI</b> <i>undertop stirrup for extension</i>   L.48 x p.9 x H.3,2	L.50	148 <b>659</b> (*)	1	0,004	1	€ 23,00	200 GRIGIO grey
							440 BIANCO white
							844 STONE GREY stone grey

## PENISOLA E ANGOLO DI RACCORDO

terminal and joining segment

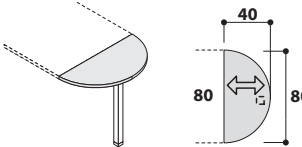
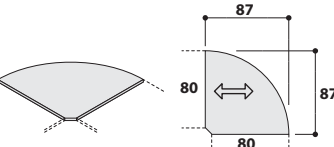
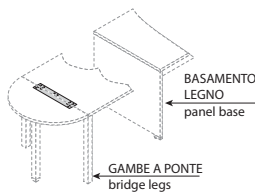
DESCRIZIONE description	L w	CODICE code	KG	M <sup>3</sup>	COLLI	PREZZO price	(*) CODICE FINITURA (*) finish code																																																							
PENISOLA PER SCRIVANIA PROF. CM 80 terminal for desk depth 80 cms    H.73,6		148 558 (*)	11	0,029	2	€ 85,00	<table border="1"> <thead> <tr> <th>(*)</th> <th>PIANO</th> <th>GAMBA</th> <th>top</th> <th>leg</th> </tr> </thead> <tbody> <tr> <td>003</td> <td>ROVERE</td> <td>ARGENTO</td> <td>oak</td> <td>silver</td> </tr> <tr> <td>025</td> <td>GRIGIO</td> <td>ARGENTO</td> <td>grey</td> <td>silver</td> </tr> <tr> <td>040</td> <td>BIANCO BR.</td> <td>ARGENTO</td> <td>br. white</td> <td>silver</td> </tr> <tr> <td>066</td> <td>NOCE PAVIA</td> <td>ARGENTO</td> <td>pavia walnut</td> <td>silver</td> </tr> <tr> <td>403</td> <td>ROVERE</td> <td>BIANCO</td> <td>oak</td> <td>white</td> </tr> <tr> <td>440</td> <td>BIANCO BR.</td> <td>BIANCO</td> <td>br. white</td> <td>white</td> </tr> <tr> <td>466</td> <td>NOCE PAVIA</td> <td>BIANCO</td> <td>pavia walnut</td> <td>white</td> </tr> <tr> <td>803</td> <td>ROVERE</td> <td>STONE GREY</td> <td>oak</td> <td>stone grey</td> </tr> <tr> <td>844</td> <td>STONE GREY</td> <td>STONE GREY</td> <td>stone grey</td> <td>stone grey</td> </tr> <tr> <td>866</td> <td>NOCE PAVIA</td> <td>STONE GREY</td> <td>pavia walnut</td> <td>stone grey</td> </tr> </tbody> </table>	(*)	PIANO	GAMBA	top	leg	003	ROVERE	ARGENTO	oak	silver	025	GRIGIO	ARGENTO	grey	silver	040	BIANCO BR.	ARGENTO	br. white	silver	066	NOCE PAVIA	ARGENTO	pavia walnut	silver	403	ROVERE	BIANCO	oak	white	440	BIANCO BR.	BIANCO	br. white	white	466	NOCE PAVIA	BIANCO	pavia walnut	white	803	ROVERE	STONE GREY	oak	stone grey	844	STONE GREY	STONE GREY	stone grey	stone grey	866	NOCE PAVIA	STONE GREY	pavia walnut	stone grey
	(*)	PIANO	GAMBA	top	leg																																																									
	003	ROVERE	ARGENTO	oak	silver																																																									
	025	GRIGIO	ARGENTO	grey	silver																																																									
	040	BIANCO BR.	ARGENTO	br. white	silver																																																									
	066	NOCE PAVIA	ARGENTO	pavia walnut	silver																																																									
	403	ROVERE	BIANCO	oak	white																																																									
	440	BIANCO BR.	BIANCO	br. white	white																																																									
	466	NOCE PAVIA	BIANCO	pavia walnut	white																																																									
	803	ROVERE	STONE GREY	oak	stone grey																																																									
844	STONE GREY	STONE GREY	stone grey	stone grey																																																										
866	NOCE PAVIA	STONE GREY	pavia walnut	stone grey																																																										
<b>ATTENZIONE! IN ABBINAMENTO A SCRIVANIE CON BASAMENTO LEGNO O GAMBE A PONTE COMPLETARE SEMPRE CON 1 STAFFA ART.275 (VEDI SCHEMA SOTTO)</b> <i>attention! in combining to desks with panel base or bridge legs to be always complete with 1 stirrup art.275 (please see scheme)</i>																																																														
ANGOLO DI RACCORDO 90° PER SCRIVANIE PROF. CM 80 90° joining segment for desks depth 80 cms    H.2,5		148 559 (*)	12	0,046	1	€ 67,00	<table border="1"> <thead> <tr> <th>(*)</th> <th>PIANO</th> <th>top</th> </tr> </thead> <tbody> <tr> <td>166</td> <td>NOCE PAVIA</td> <td>pavia walnut</td> </tr> <tr> <td>200</td> <td>GRIGIO</td> <td>grey</td> </tr> <tr> <td>440</td> <td>BIANCO BR.</td> <td>br. white</td> </tr> <tr> <td>733</td> <td>ROVERE</td> <td>oak</td> </tr> <tr> <td>844</td> <td>STONE GREY</td> <td>stone grey</td> </tr> </tbody> </table>	(*)	PIANO	top	166	NOCE PAVIA	pavia walnut	200	GRIGIO	grey	440	BIANCO BR.	br. white	733	ROVERE	oak	844	STONE GREY	stone grey																																					
	(*)	PIANO	top																																																											
	166	NOCE PAVIA	pavia walnut																																																											
	200	GRIGIO	grey																																																											
	440	BIANCO BR.	br. white																																																											
	733	ROVERE	oak																																																											
	844	STONE GREY	stone grey																																																											
	<b>ATTENZIONE! IN ABBINAMENTO A SCRIVANIE CON BASAMENTO LEGNO O GAMBE A PONTE COMPLETARE SEMPRE CON 2 STAFFE ART.275 (VEDI SCHEMA SOTTO)</b> <i>attention! in combining to desks with panel base or bridge legs to be always complete with 2 stirrups art.275 (please see scheme)</i>																																																													
	STAFFA PER FISSAGGIO PENISOLA E ANGOLO (ART.558-559) <b>SU SCRIVANIE CON BASAMENTO LEGNO O GAMBE A PONTE</b> fixing stirrup terminal and joining segment (ART.558-559) <b>on desks with panel base or bridge legs</b>   L.55 x p.7,1 x H.0,12	L.55	148 275 (*)	2	0,005	1	€ 15,00	<table border="1"> <thead> <tr> <th>(*)</th> <th></th> <th></th> </tr> </thead> <tbody> <tr> <td>000</td> <td>ARGENTO</td> <td>silver</td> </tr> <tr> <td>440</td> <td>BIANCO</td> <td>white</td> </tr> <tr> <td>844</td> <td>STONE GREY</td> <td>stone grey</td> </tr> </tbody> </table>	(*)			000	ARGENTO	silver	440	BIANCO	white	844	STONE GREY	stone grey																																										
		(*)																																																												
000		ARGENTO	silver																																																											
440		BIANCO	white																																																											
844	STONE GREY	stone grey																																																												
<b>ATTENZIONE! IN ABBINAMENTO A SCRIVANIE CON BASAMENTO LEGNO O GAMBE A PONTE COMPLETARE SEMPRE CON 2 STAFFE ART.275 (VEDI SCHEMA SOTTO)</b> <i>attention! in combining to desks with panel base or bridge legs to be always complete with 2 stirrups art.275 (please see scheme)</i>																																																														

## SCHEMA DI UTILIZZO PENISOLA E ANGOLO DI RACCORDO

scheme for using the terminal and joining segment

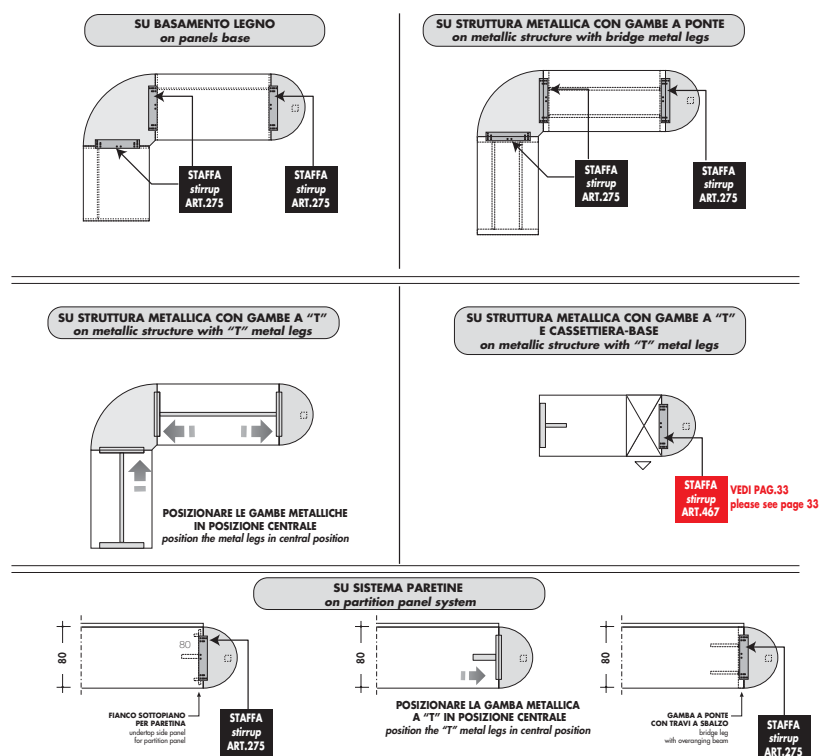

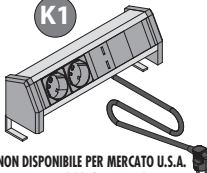
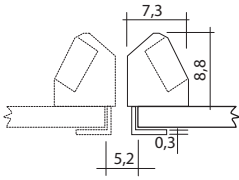
KIT ELETRIFICAZIONE tipo K1 (BACHMANN) electrification kit type K1 (by Bachmann)							BACHMANN			
DESCRIZIONE description	L w	CODICE code	KG	M <sup>3</sup>	COLLI	PREZZO price	(*) CODICE FINITURA (*) finish code			
1 KIT ELETRIFICAZIONE ORIZZONTALE CON MORSETTO PER FISSAGGIO A SCRIVANIA (CON CAVO DI ALIMENTAZIONE MT. 2,00 E PRESE STANDARD) CON 1 MODULO PERSONALIZZABILE OPTIONAL 1 electrification kit with fixing clamp on desktop (power cable of w 2 lmt. and standard sockets) with 1 customizable module (OPTIONAL)   <p><b>K1</b></p> <p>NON DISPONIBILE PER MERCATO U.S.A. not available for US market</p>  <p>L.28,1 x p.7,3 x H.8,8</p>		175 117 (*)	1,5	0,010	2	€ 257,00				
			175 118 (*)	1,5	0,010	2	€ 243,00			
			175 119 (*)	1,5	0,010	2	€ 270,00			
								(*)		
								000	ARGENTO	silver

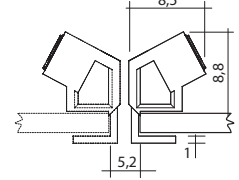
KIT ELETRIFICAZIONE tipo K2 (BACHMANN) electrification kit type K2 (by Bachmann)							BACHMANN			
DESCRIZIONE description	L w	CODICE code	KG	M <sup>3</sup>	COLLI	PREZZO price	(*) CODICE FINITURA (*) finish code			
1 KIT ELETRIFICAZIONE ORIZZONTALE CON MORSETTO PER FISSAGGIO A SCRIVANIA (CON CAVO DI ALIMENTAZIONE MT. 2,00 E PRESE STANDARD) CON 1 MODULO PERSONALIZZABILE OPTIONAL 1 electrification kit with fixing clamp on desktop (power cable of w 2 lmt. and standard sockets) with 1 customizable module (OPTIONAL)   <p><b>K2</b></p> <p>NON DISPONIBILE PER MERCATO U.S.A. not available for US market</p>  <p>L.28,1 x p.8,5 x H.8,8</p>		175 120 (*)	1,5	0,010	2	€ 317,00				
			175 121 (*)	1,5	0,010	2	€ 285,00			
			175 122 (*)	1,5	0,010	2	€ 343,00			
								(*)		
								450	BIANCO	white
								500	NERO	black

MODULI PERSONALIZZABILI (BACHMANN) customizable modules (by Bachmann)							BACHMANN		
DESCRIZIONE description	L w	CODICE code	KG	M <sup>3</sup>	COLLI	PREZZO price	(*) CODICE FINITURA (*) finish code		
1 MODULO PERSONALIZZABILE 1 customizable module  RIMUOVERE IL TAPPO IN DOTAZIONE E INSERIRE QUI REMOVE THE CAP AND INSERT HERE   <p>L.4,5 x H.4,5</p>		175 123 (*)	0,5	0,001	1	€ 39,00			
		175 124 (*)	0,5	0,001	1	€ 73,00			
		175 125 (*)	0,5	0,001	1	€ 73,00			
								(*)	
							500	NERO	black



**KIT ELETTTRIFICAZIONE TIPO Y3**

*electrification kit type Y3*

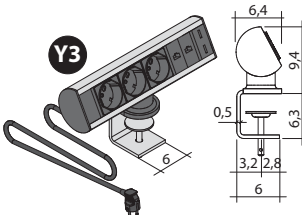
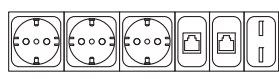
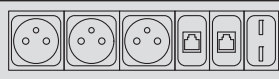
DESCRIZIONE <i>description</i>	L <i>w</i>	CODICE <i>code</i>	KG	M <sup>3</sup>	COLLI	PREZZO <i>price</i>	(*) CODICE FINITURA <i>(*) finish code</i>	
<p>KIT ELETTTRIFICAZIONE ORIZZONTALE CON MORSETTO PER FISSAGGIO A SCRIVANIA (CON CAVO DI ALIMENTAZIONE MT. 3,00 E PRESE STANDARD) <i>electrification kit with fixing clamp on desktop (power cable of w 3 lmt. and standard sockets)</i></p>  <p><b>NON DISPONIBILE PER MERCATO U.S.A.</b> <i>not available for US market</i></p> <p>L.26 x p.6,4 x H.9,4+6,3</p>		<b>175 106 (*)</b>	2	0,010	1	<b>€ 144,00</b>		
			<b>3 PRESE STANDARD ITALIA/GERMANIA (SCHUKO)</b> <b>2 KIT DATI RJ45 CAT.6 + 2 USB</b> <i>3 Italia/Germany standard sockets 2 data kit RJ45 Cat.6 + 2 USB</i>					
		<b>175 107 (*)</b>	2	0,010	1	<b>€ 144,00</b>		
			<b>3 PRESE STANDARD FRANCIA</b> <b>2 KIT DATI RJ45 CAT.6 + 2 USB</b> <i>3 France standard sockets 2 data kit RJ45 Cat.6 + 2 USB</i>					
							(*) <b>000</b> ARGENTO <i>silver</i>	

**SCHEMA DI UTILIZZO KIT ELETTTRIFICAZIONE**

*scheme of use electrification kit*

**OXI**

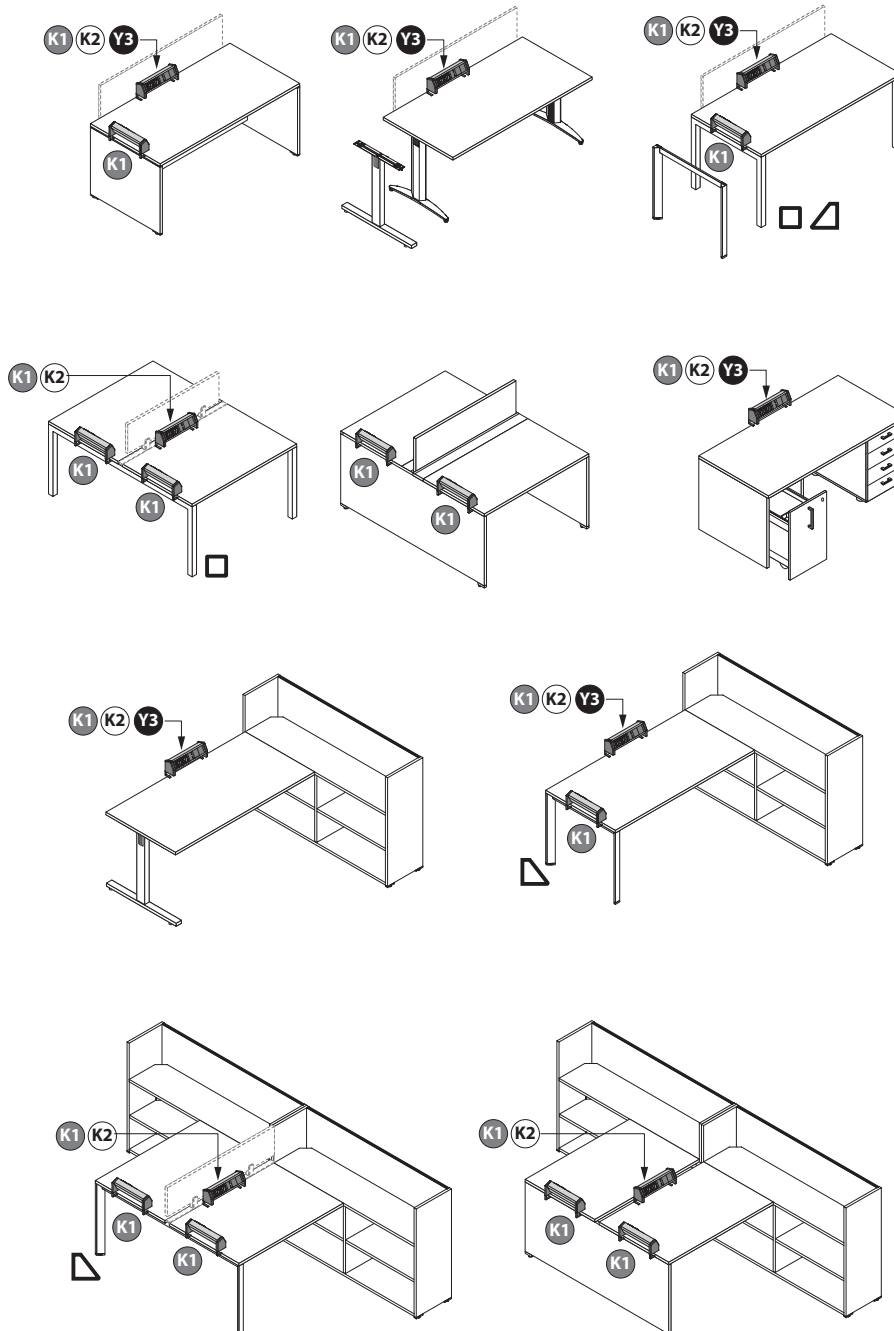

- INFORMAZIONI TECNICHE -  
-Technical information-

**SCHEMA BASAMENTI SOTTOPIANO E PARETINE UTILIZZABILI PER SUPPORTARE PIANI LINEARI**  
scheme of undertop base and partition walls used as support of linear tops

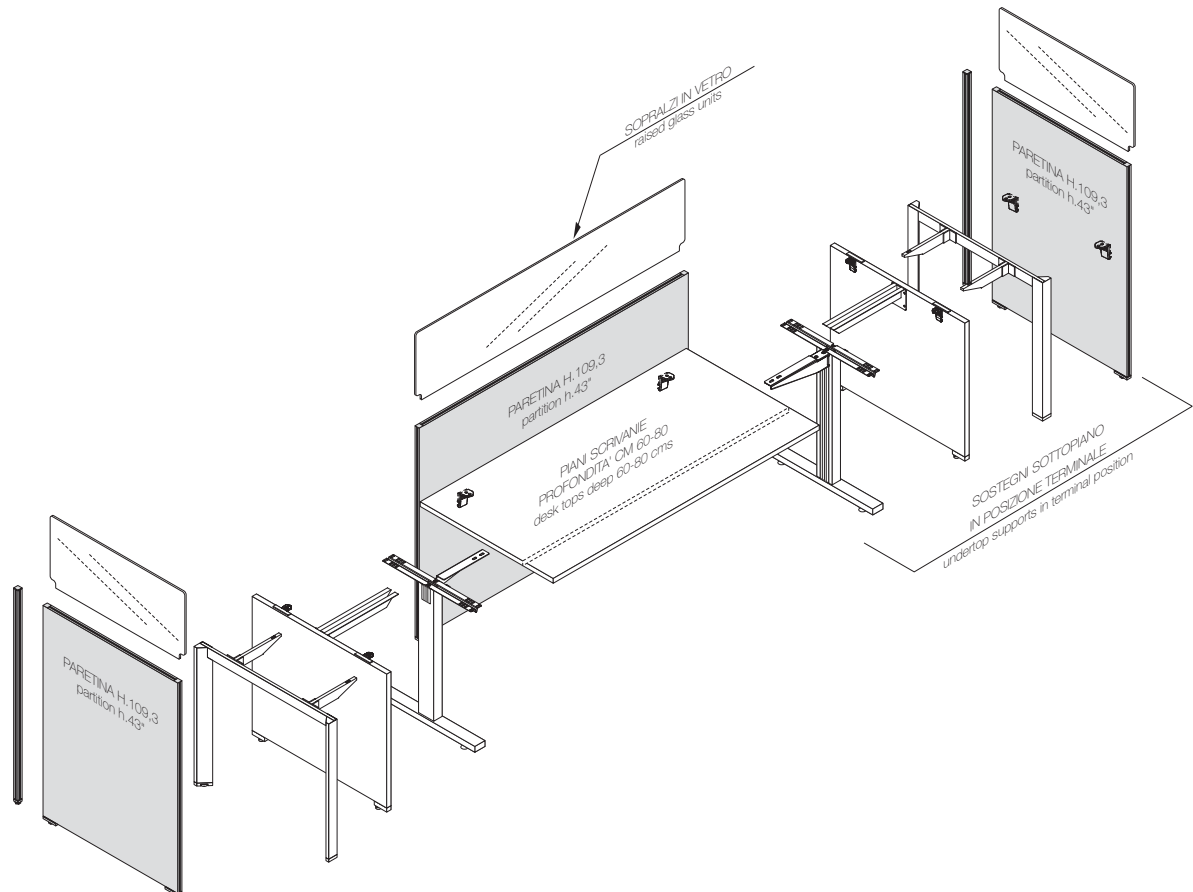

**SCHEMA DI UTILIZZO SOSTEGNI SOTTOPIANO**  
scheme of using for undertop supports

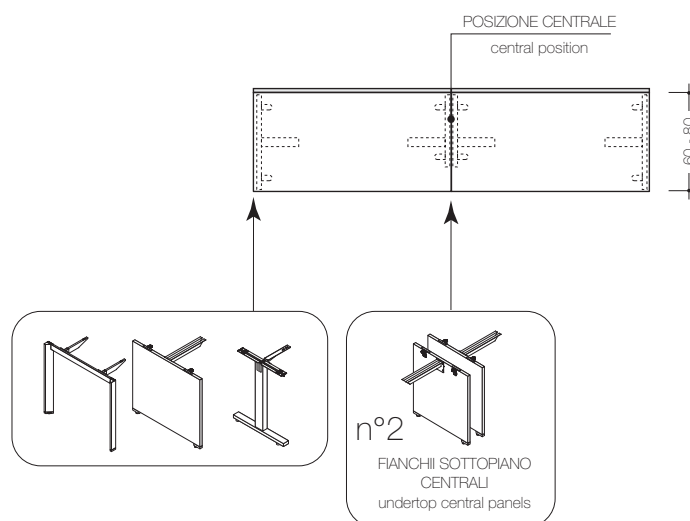

- INFORMAZIONI TECNICHE -  
-Technical information-

**SCHEMA BASAMENTI SOTTOPIANO E PARETINE UTILIZZABILI PER SUPPORTARE PIANI WORKSTATION**  
scheme of undertop base and partition walls used as support of workstation tops

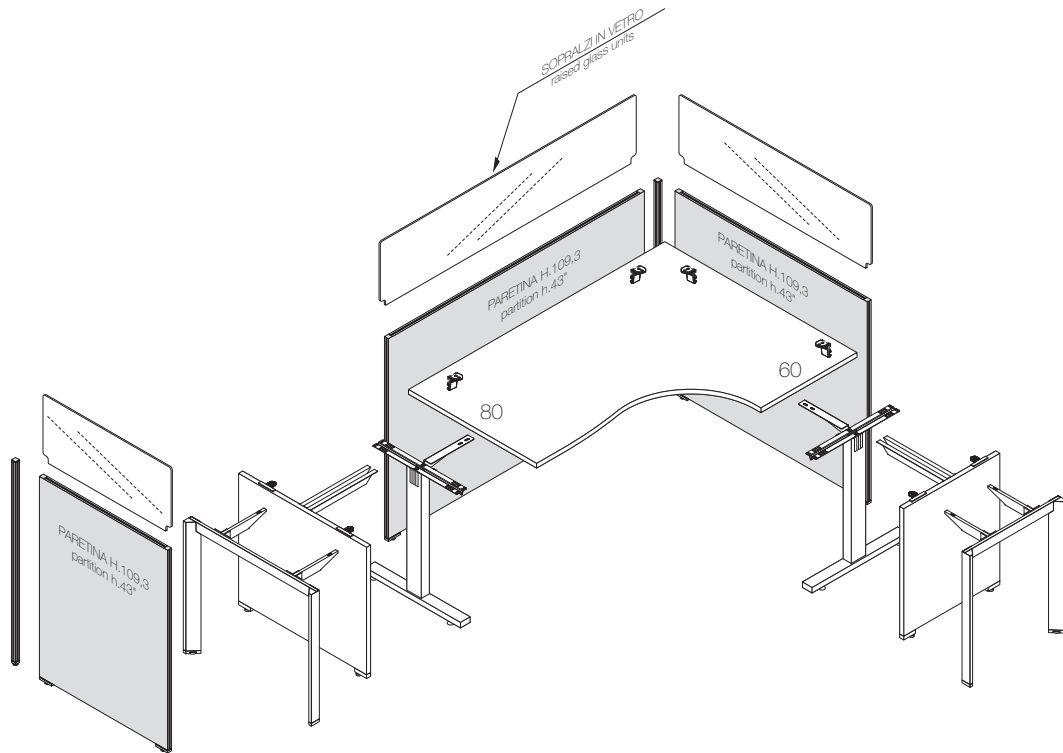

SCHEMA DI UTILIZZO SOSTEGNI SOTTOPIANO  
scheme of using for undertop supports

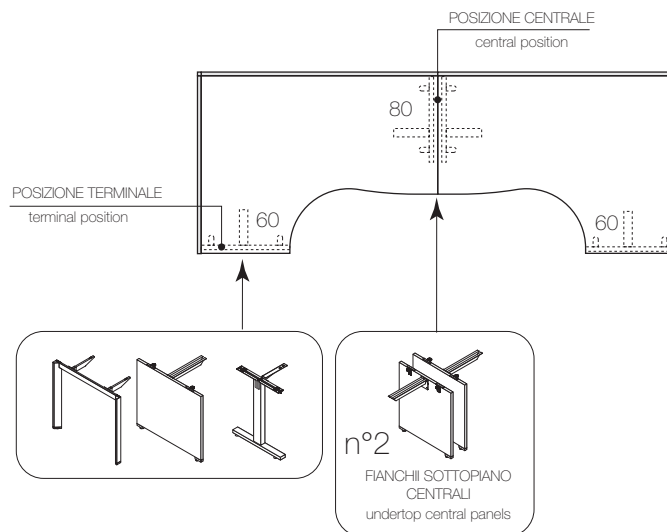

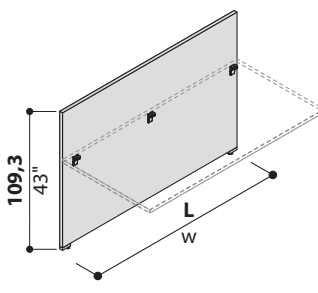
PARETINE MONO-PANNELLO H.109,3 single element panels H.109,3 cms							
DESCRIZIONE description	L W	CODICE code	KG	M <sup>3</sup>	COLLI	PREZZO price	(*) CODICE FINITURA (*) finish code
PARETINE MONO-PANNELLO H.109,3 single element panels h.109,3 cms  	MELAMINICO melamine	L.60	148 415 (*)	12	0,035	1	€ 101,00
		L.80	148 416 (*)	15	0,046	1	€ 116,00
		L.100	148 417 (*)	18	0,057	1	€ 137,00
		L.120	148 418 (*)	22	0,068	1	€ 158,00
		L.140	148 419 (*)	26	0,080	1	€ 174,00
		L.160	148 420 (*)	29	0,090	1	€ 190,00
		L.180	148 421 (*)	33	0,102	1	€ 207,00
		A FINE COMPOSIZIONE COMPLETARE CON PROFILO TERMINALE PER PARETINA (OPTIONAL) VEDI PAGINA 49 for complete the composition add terminal profile for partition panel (OPTIONAL), please see page 49					
							(*)
							MELAMINICO
							melamine
							005 ARGENTO GOLF
							golf silver
							440 BIANCO BR.
							br. white
							844 STONE GREY
							stone grey
L. x p.2,5 x H.109,3							

**PARETINE MONO-PANNELLO H.135**  
single element panels H.135 cms

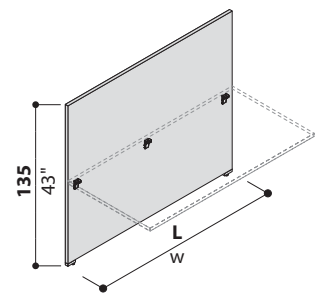
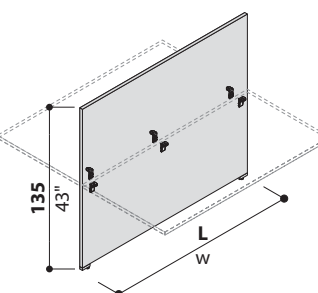
PARETINE MONO-PANNELLO H.135 single element panels h 135 cms  	MELAMINICO melamine	L.60	148 450 (*)	15	0,041	1	€ 118,00
		L.80	148 451 (*)	19	0,054	1	€ 137,00
		L.100	148 452 (*)	23	0,077	1	€ 156,00
		L.120	148 453 (*)	27	0,101	1	€ 182,00
		L.140	148 460 (*)	31	0,090	1	€ 201,00
		L.160	148 461 (*)	36	0,102	1	€ 221,00
		L.180	148 462 (*)	42	0,115	1	€ 240,00
		A FINE COMPOSIZIONE COMPLETARE CON PROFILO TERMINALE PER PARETINA (OPTIONAL) VEDI PAGINA 49 for complete the composition add terminal profile for partition panel (OPTIONAL), please see page 49					
							(*)
							MELAMINICO
							melamine
							005 ARGENTO GOLF
							golf silver
							440 BIANCO BR.
							br. white
							844 STONE GREY
							stone grey
L. x p.2,5 x H.135							
PARETINE MONO-PANNELLO CENTRALI H.135 central single element panels h 135 cms  	MELAMINICO melamine	L.60	148 455 (*)	15	0,041	1	€ 123,00
		L.80	148 456 (*)	19	0,054	1	€ 142,00
		L.100	148 457 (*)	23	0,077	1	€ 162,00
		L.120	148 458 (*)	27	0,101	1	€ 190,00
		L.140	148 463 (*)	31	0,090	1	€ 210,00
		L.160	148 464 (*)	36	0,102	1	€ 229,00
		L.180	148 465 (*)	42	0,115	1	€ 248,00
		A FINE COMPOSIZIONE COMPLETARE CON PROFILO TERMINALE PER PARETINA (OPTIONAL) VEDI PAGINA 49 for complete the composition add terminal profile for partition panel (OPTIONAL), please see page 49					
							(*)
							MELAMINICO
							melamine
							005 ARGENTO GOLF
							golf silver
							440 BIANCO BR.
							br. white
							844 STONE GREY
							stone grey
L. x p.2,5 x H.135							



**PARETINE MONO-PANNELLO H.160**  
single element panels H.160 cms

DESCRIZIONE description	L w	CODICE code	KG	M <sup>3</sup>	COLLI	PREZZO price	(*) CODICE FINITURA (*) finish code
----------------------------	--------	----------------	----	----------------	-------	-----------------	----------------------------------------

PARETINE MONO-PANNELLO H.160  
single element panels h 160 cms

L x p.2,5 x H.160

MELAMINICO melamine	L	148	KG	M <sup>3</sup>	COLLI	PREZZO
L.60	<b>468 (*)</b>	19	0,047	1	€ 134,00	
L.70	<b>469 (*)</b>	21	0,053	1	€ 145,00	
L.80	<b>470 (*)</b>	23	0,062	1	€ 157,00	
L.90	<b>471 (*)</b>	23	0,077	1	€ 168,00	
L.100	<b>472 (*)</b>	27	0,090	1	€ 180,00	
L.120	<b>473 (*)</b>	34	0,107	1	€ 203,00	

**A FINE COMPOSIZIONE COMPLETARE CON PROFILO TERMINALE PER PARETINA (OPTIONAL) VEDI PAGINA 49**  
for complete the composition add terminal profile for partition panel (OPTIONAL), please see page 49

(*)	MELAMINICO	melamine
005	ARGENTO GOLF	golf silver
440	BIANCO BR.	br. white
844	STONE GREY	stone grey

PARETINE MONO-PANNELLO **CENTRALI** H.160  
central single element panels h 160 cms

L x p.2,5 x H.160

MELAMINICO melamine	L	148	KG	M <sup>3</sup>	COLLI	PREZZO
L.60	<b>474 (*)</b>	19	0,047	1	€ 139,00	
L.70	<b>475 (*)</b>	21	0,053	1	€ 150,00	
L.80	<b>476 (*)</b>	23	0,062	1	€ 162,00	
L.90	<b>477 (*)</b>	27	0,077	1	€ 173,00	
L.100	<b>478 (*)</b>	31	0,090	1	€ 185,00	
L.120	<b>479 (*)</b>	34	0,107	1	€ 212,00	

**A FINE COMPOSIZIONE COMPLETARE CON PROFILO TERMINALE PER PARETINA (OPTIONAL) VEDI PAGINA 49**  
for complete the composition add terminal profile for partition panel (OPTIONAL), please see page 49

**MONTANTI RACCORDO PER PARETINE**  
uprights for panel system

MONTANTE DI RACCORDO 2-3-4 VIE  
joining upright 2-3-4 ways

L.2,5 x p.2,5 x H.

H	148	KG	M <sup>3</sup>	COLLI	PREZZO
H.109,3	<b>486 (*)</b>	1	0,008	1	€ 26,00
H.135	<b>487 (*)</b>	2	0,010	1	€ 27,00
H.160	<b>488 (*)</b>	2,5	0,011	1	€ 28,00

(*)		
200	GRIGIO	grey
440	BIANCO	white
844	STONE GREY	stone grey

**PER OGNI CONNESSIONE A 2-3-4 VIE ORTOGONALI CON PANNELLI PARETINA OCCORRE INSERIRE 1 MONTANTE DI RACCORDO ART. 486-487-488**  
for each 2-3-4 orthogonal way connection with panel, it is necessary to use 1 joining upright art. 486-487-488

ART. 486 (MONTANTE H.109,3) / (upright h.109,3 cms)  
ART. 487 (MONTANTE H.135) / (upright h.135 cms)  
ART. 488 (MONTANTE H.160) / (upright h.160 cms)



**PROFILO TERMINALE PER PARETINA (OPTIONAL)**

terminal profile for partition panel (OPTIONAL)

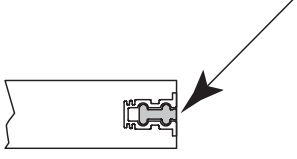
DESCRIZIONE description	H h	CODICE code	KG	M <sup>3</sup>	COLLI	PREZZO price	(*) CODICE FINITURA (*) finish code	
PROFILO TERMINALE PER PARETINA (OPTIONAL) terminal profile for partition panel (OPTIONAL)    H. height	H.109,3	148 <b>491</b> (*)	0,5	0,002	1	€ 8,00	(*)	
	H.135	148 <b>492</b> (*)	0,7	0,002	1	€ 9,00	200	GRIGIO grey
	H.160	148 <b>493</b> (*)	0,8	0,003	1	€ 10,00	440	BIANCO white
							844	STONE GREY stone grey

Esempi:  
examples:

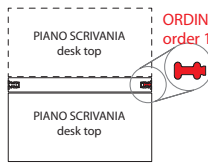

ORDINARE 1 PEZZO  
order 1 unit

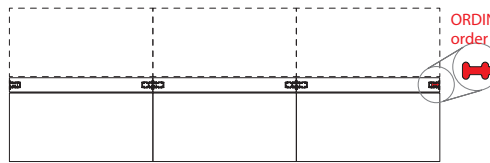

ORDINARE 1 PEZZO  
order 1 unit

- COMPOSIZIONE A 2 VIE -  
2 ways composition

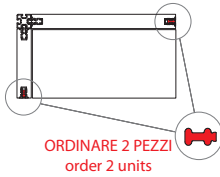

ORDINARE 2 PEZZI  
order 2 units

- COMPOSIZIONE A 3 VIE -  
3 ways composition

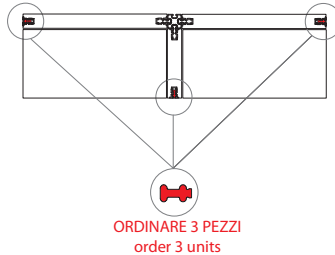

ORDINARE 3 PEZZI  
order 3 units

- COMPOSIZIONE A 4 VIE -  
4 ways composition

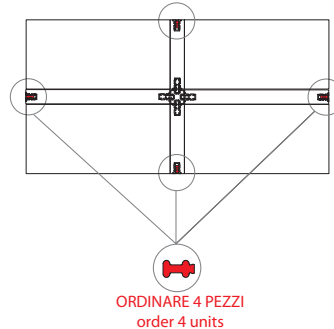

ORDINARE 4 PEZZI  
order 4 units

**VASCHETTA PASSACAVI PER PARETINA**

cable-trays for partition panel

VASCHETTA PASSACAVI PER PARETINA  
cable-tray for partition panel

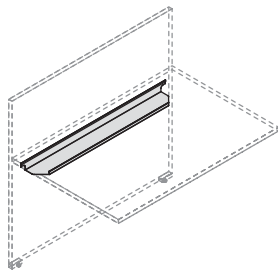

L. PORTACAVI w cable channel	UTILIZZARE SU PARETINA use on partition panel		KG	M <sup>3</sup>	COLLI	PREZZO price	(*) CODICE FINITURA (*) finish code	
L.49	L.60	148 <b>501</b> (*)	1,2	0,008	1	€ 26,00	(*)	
L.59	L.70	148 <b>502</b> (*)	1,4	0,008	1	€ 27,00	000	ARGENTO silver
L.69	L.80	148 <b>503</b> (*)	1,4	0,009	1	€ 28,00	440	BIANCO white
L.79	L.90	148 <b>504</b> (*)	1,5	0,014	1	€ 30,00	844	STONE GREY stone grey
L.89	L.100	148 <b>505</b> (*)	1,8	0,014	1	€ 31,00		
L.109	L.120	148 <b>506</b> (*)	1,9	0,021	1	€ 34,00		
L.129	L.140	148 <b>507</b> (*)	2,2	0,021	1	€ 37,00		
L.149	L.160	148 <b>508</b> (*)	2,7	0,021	1	€ 41,00		
L.169	L.180	148 <b>509</b> (*)	3	0,022	1	€ 44,00		

KIT 4 GHIERE DI COPERTURA FORO Ø 60mm  
PER PANNELLI PARETINE  
set of 4 cable-ways Ø 60mm for partition panels

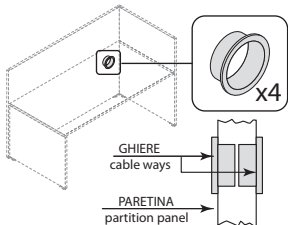

Ø 6 x H.1,25

		152 <b>759</b> (*)	1	0,002	1	€ 18,00	(*)	
--	--	--------------------	---	-------	---	---------	-----	--





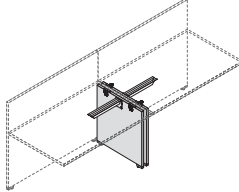
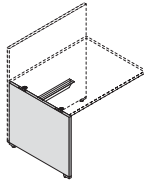
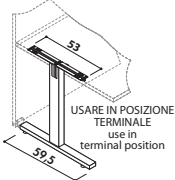
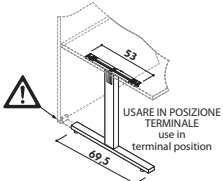
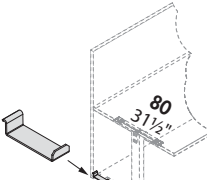
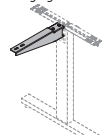
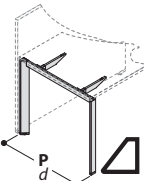

UTILIZZABILI SU ENTRAMBI I LATI DELLE PARETINE  
usable on both sides of the partition panels

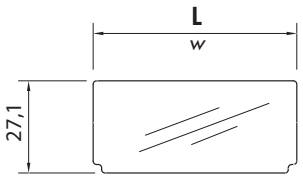
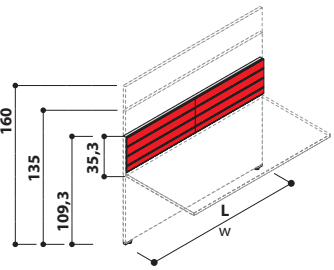
000	ARGENTO	silver
-----	---------	--------

SOSTEGNI PER PIANI INTEGRABILI SU PARETINE								
supports for tops connectable to partitions								
DESCRIZIONE description	L w	CODICE code	KG	M <sup>3</sup>	COLLI	PREZZO price	(*) CODICE FINITURA (*) finish code	
2 FIANCHI SOTTOPIANO <b>CENTRALI</b> PER PARETINE <b>2 central</b> undertop panels for partition  L x p.2,5 x H.71,1		148 <b>499</b> (*)	13	0,024	3	€ 109,00		
	<b>CON GANCI DI ATTACCO A PARETINA INCLUSI</b> with hooks included for connection to partition panel							
								(*) MELAMINICO melamine
							005 ARGENTO GOLF golf silver	
FIANCO <b>TERMINALE</b> PER PARETINE <b>terminal</b> side panel for partition  L x p.2,5 x H.71,1	L.60	148 <b>483</b> (*)	8	0,021	2	€ 60,00	440 BIANCO BR. br. white	
	L.80	148 <b>484</b> (*)	10	0,026	2	€ 65,00	844 STONE GREY stone grey	
	<b>CON GANCIO DI ATTACCO A PARETINA INCLUSO</b> with hook included for connection to partition panel							
GAMBA SINGOLA A "T" <b>PER PIANI PROF. CM 60</b> single "T" leg for desk top depth 60 cms  H.71,1		148 <b>150</b> (*)	6	0,041	1	€ 66,00		
	<b>CON STAFFA DI ATTACCO A PARETINA INCLUSA</b> with stirrup included for connection to partition panel							
GAMBA SINGOLA A "T" <b>PER PIANI PROF. CM 80</b> single "T" leg for desk top depth 80 cms  H.71,1		148 <b>151</b> (*)	7	0,048	1	€ 67,00		
	<b>PER ATTACCO A PARETINA COMPLETARE SEMPRE CON STAFFA ART.657</b> for connection to partition panel to be always complete with stirrup art.657							
								(*) ARGENTO silver
							000 ARGENTO silver	
							440 BIANCO white	
							844 STONE GREY stone grey	
STAFFA <b>PER GAMBA ART.151</b> stirrup for leg art.151  L.6,5 x p.2 x H.1,5		148 <b>657</b> (*)	0,5	0,001	1	€ 8,00		
TRAVE A SBALZO PER GAMBE A "T" overanging beam "T" legs  L.32		148 <b>524</b> (*)	1	0,001	1	€ 17,00		
GAMBA A "PONTE" <b>TERMINALE</b> TRAPEZOIDALE CON TRAVI A SBALZO terminal "bridge" leg with trapezoidal section with overanging beam  H.71,1	p.60	148 <b>480</b> (*)	7,5	0,039	2	€ 116,00	(*) ARGENTO silver	
	p.80	148 <b>481</b> (*)	8	0,051	2	€ 119,00	440 BIANCO white	
	<b>CON GANCIO DI ATTACCO A PARETINA INCLUSO</b> with hook included for connection to partition panel							844 STONE GREY stone grey

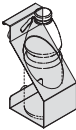

ACCESSORI PER PARETINE accessories for partition panels								
DESCRIZIONE description	L w	CODICE code	KG	M <sup>3</sup>	COLLI	PREZZO price	(*) CODICE FINITURA (*) finish code	
<p>SOPRALZI IN VETRO TEMPERATO raised tempered glass units</p>  <p>L x p,0,5 x H,27,1</p>	L.60	148 590 (*)	2	0,012	1	€ 41,00		
	L.70	148 591 (*)	2,5	0,014	1	€ 42,00		
	L.80	148 592 (*)	2,7	0,016	1	€ 44,00		
	L.90	148 593 (*)	3	0,018	1	€ 46,00		
	L.100	148 594 (*)	3,3	0,020	1	€ 48,00	(*)	
	L.120	148 595 (*)	4	0,024	1	€ 50,00	250 VETRO TEMPERATO TRASPARENTE transparent tempered white glass	
	L.140	148 596 (*)	4,6	0,028	1	€ 54,00		
	L.160	148 597 (*)	5,2	0,032	1	€ 57,00		
	L.180	148 598 (*)	5,8	0,036	1	€ 60,00		
	<p>KIT RIVESTIMENTO FONO-ASSORBENTE PER 1 SOLO LATO upholstered sound-proofing cover kit for one side only</p>  <p>L x p,0,6 x H,35,3</p>	L.60	148 900 (*)	0,5	0,007	1	€ 34,00	
L.70		148 914 (*)	0,5	0,013	1	€ 39,00		
L.80		148 901 (*)	0,7	0,009	1	€ 43,00	(*) TESSUTO POLIESTERE STRETCH IGNIFUGO fire-retardant stretch polyester fabric	
L.100		148 902 (*)	0,8	0,010	1	€ 58,00	320 AZZURRO SKY sky blue	
L.120		148 903 (*)	0,9	0,010	1	€ 64,00	321 GIALLO FRESIA freesia yellow	
L.140		148 904 (*)	1	0,013	1	€ 75,00	322 AMARANTO amaranth	
L.160		148 905 (*)	1,3	0,013	1	€ 82,00	323 VERDE BOSCO wood green	
L.180		148 906 (*)	1,3	0,010	1	€ 93,00	328 TORTORA grey beige	

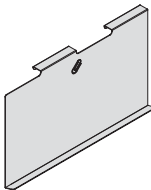
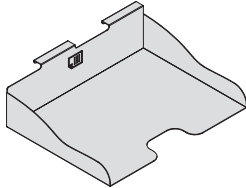
ACCESSORI PER PARETINE accessories for partition panels																			
DESCRIZIONE description	L w	CODICE code	KG	M <sup>3</sup>	COLLI	PREZZO price	(*) CODICE FINITURA (* finish code)												
<p>1 GANCIO 1 hook</p>  <p>L.2,5 x p.3,3 x H.13,4</p>		148 927 (*)	0,3	0,002	1	€ 24,00													
<p>PORTA-FIORE CON PROVETTA flower-holder with tube</p>  <p>L.4 x p.10 x H.13,4</p>		148 928 (*)	0,3	0,002	1	€ 29,00													
<p>PORTA-BOTTIGLIA bottle-holder</p>  <p>L.8 x p.10 x H.17,6</p>		148 929 (*)	0,3	0,002	1	€ 28,00													
<p>PORTA-PENNE pen-holder</p>  <p>L.8,2 x p.8 x H.11</p>		148 930 (*)	0,3	0,002	1	€ 28,00													
<p>PORTA-CELLULARE smartphone-holder</p>  <p>L.16,4 x p.9 x H.13,4</p>		148 931 (*)	0,3	0,002	1	€ 30,00	<table border="1"> <tr> <td>(*)</td> <td></td> <td></td> </tr> <tr> <td>000</td> <td>ARGENTO</td> <td>silver</td> </tr> <tr> <td>440</td> <td>BIANCO</td> <td>white</td> </tr> <tr> <td>844</td> <td>STONE GREY</td> <td>stone grey</td> </tr> </table>	(*)			000	ARGENTO	silver	440	BIANCO	white	844	STONE GREY	stone grey
(*)																			
000	ARGENTO	silver																	
440	BIANCO	white																	
844	STONE GREY	stone grey																	
<p>PORTA-TABLET tablet-holder</p>  <p>L.25 x p.13,2 x H.20,6</p>		148 932 (*)	0,7	0,025	1	€ 35,00													
<p>LAVAGNA METALLICA metallic board</p>  <p>L.33 x p.3,7 x H.19,3</p>		148 933 (*)	0,7	0,025	1	€ 35,00													
<p>PORTA-CARTA A4 A4 paper-holder</p>  <p>L.33,2 x p.26,9 x H.9</p>		148 934 (*)	1,2	0,025	1	€ 35,00													

PIANI sp. 25mm  
tops thick. 25mm

TAVOLO DA SALOTTO coffee table							PIANI sp. 25mm tops thick. 25mm				
DESCRIZIONE description	L w	CODICE code	KG	M <sup>3</sup>	COLLI	PREZZO price	(*) CODICE FINITURA (*) finish code				
TAVOLO DA SALOTTO L.60 coffee table w 60 cms    L.60 x p.60 x H.38	L.60	148 563 (*)	19	0,037	1	€ 130,00	(*)				
							003	ROVERE	ARGENTO GOLF	oak	golf silver
							025	GRIGIO	ARGENTO GOLF	grey	golf silver
							040	BIANCO BR.	ARGENTO GOLF	br. white	golf silver
							066	NOCE PAVIA	ARGENTO GOLF	pavia walnut	golf silver
							166	NOCE PAVIA	NOCE PAVIA	pavia walnut	pavia walnut
							403	ROVERE	BIANCO BR.	oak	br. white
							440	BIANCO BR.	BIANCO BR.	br. white	br. white
							466	NOCE PAVIA	BIANCO BR.	pavia walnut	br. white
							803	ROVERE	STONE GREY	oak	stone grey
							844	STONE GREY	STONE GREY	stone grey	stone grey
							866	NOCE PAVIA	STONE GREY	pavia walnut	stone grey

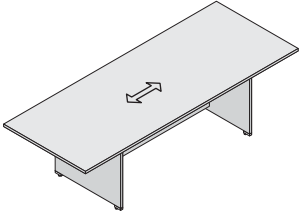
TAVOLI RIUNIONE BASAMENTO LEGNO meeting table with panel base							PIANI sp. 25mm tops thick. 25mm				
DESCRIZIONE description	L w	CODICE code	KG	M <sup>3</sup>	COLLI	PREZZO price	(*) CODICE FINITURA (*) finish code				
TAVOLO RIUNIONE RETTANGOLARE CON BASAMENTO LEGNO rectangular meeting table with panels base    L. x p.100 x H.73,6	L.210	148 566 (*)	53	0,196	3	€ 204,00	(*)				
							003	ROVERE	ARGENTO GOLF	oak	golf silver
							025	GRIGIO	ARGENTO GOLF	grey	golf silver
							040	BIANCO BR.	ARGENTO GOLF	br. white	golf silver
							066	NOCE PAVIA	ARGENTO GOLF	pavia walnut	golf silver
							166	NOCE PAVIA	NOCE PAVIA	pavia walnut	pavia walnut
							403	ROVERE	BIANCO BR.	oak	br. white
							440	BIANCO BR.	BIANCO BR.	br. white	br. white
							466	NOCE PAVIA	BIANCO BR.	pavia walnut	br. white
							803	ROVERE	STONE GREY	oak	stone grey
							844	STONE GREY	STONE GREY	stone grey	stone grey
							866	NOCE PAVIA	STONE GREY	pavia walnut	stone grey



↔ = VENATURA LEGNO  
wood veining

**PIANI sp. 25mm**  
 tops thick. 25mm

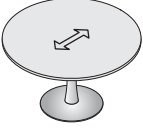
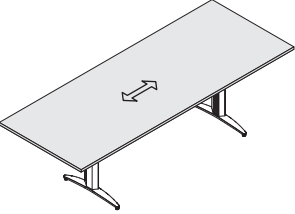
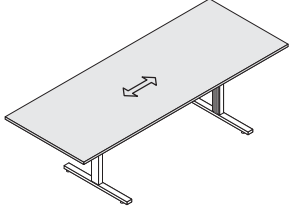
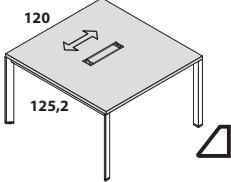
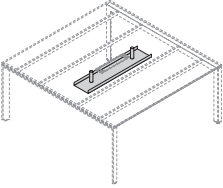

**TAVOLI RIUNIONE BASAMENTO METALLICO**
*meeting table with metal base*

DESCRIZIONE <i>description</i>	L w	CODICE code	KG	M <sup>3</sup>	COLLI	PREZZO price	(*) CODICE FINITURA (*) finish code				
TAVOLO RIUNIONE CIRCOLARE CON BASAMENTO METALLICO <i>round meeting table with metal base</i>    Ø x H.73,6	Ø 80	148 568 (*)	29	0,108	3	€ 356,00	(*)	PIANO	GAMBA	top	leg
	Ø 100	148 569 (*)	32	0,134	3	€ 381,00	003	ROVERE	ARGENTO	oak	silver
	Ø 120	148 570 (*)	39	0,158	3	€ 403,00	025	GRIGIO	ARGENTO	grey	silver
							040	BIANCO BR.	ARGENTO	br. white	silver
							066	NOCE PAVIA	ARGENTO	pavia walnut	silver
							403	ROVERE	BIANCO	oak	white
							440	BIANCO BR.	BIANCO	br. white	white
							466	NOCE PAVIA	BIANCO	pavia walnut	white
							803	ROVERE	STONE GREY	oak	stone grey
							844	STONE GREY	STONE GREY	stone grey	stone grey
						866	NOCE PAVIA	STONE GREY	pavia walnut	stone grey	
TAVOLO RIUNIONE RETTANGOLARE CON GAMBE A "T" <i>rectangular meeting table with "T" metal legs</i>    L. x p.100 x H.73,6	L.210	148 571 (*)	41	0,226	4	€ 246,00	(*)	PIANO	GAMBE	top	legs
	L.260	148 572 (*)	58	0,216	4	€ 289,00	003	ROVERE	ARGENTO	oak	silver
							025	GRIGIO	ARGENTO	grey	silver
							040	BIANCO BR.	ARGENTO	br. white	silver
							066	NOCE PAVIA	ARGENTO	pavia walnut	silver
							403	ROVERE	BIANCO	oak	white
							440	BIANCO BR.	BIANCO	br. white	white
							466	NOCE PAVIA	BIANCO	pavia walnut	white
TAVOLO RIUNIONE RETTANGOLARE CON GAMBE A "T" <i>rectangular meeting table with "T" metal legs</i>    L. x p.100 x H.73,6	L.210	148 573 (*)	46	0,246	4	€ 270,00	(*)	PIANO	GAMBE	top	legs
	L.260	148 574 (*)	63	0,236	4	€ 313,00	003	ROVERE	ARGENTO	oak	silver
							040	BIANCO BR.	ARGENTO	br. white	silver
							066	NOCE PAVIA	ARGENTO	pavia walnut	silver
							403	ROVERE	BIANCO	oak	white
							440	BIANCO BR.	BIANCO	br. white	white
							466	NOCE PAVIA	BIANCO	pavia walnut	white
							803	ROVERE	STONE GREY	oak	stone grey
							844	STONE GREY	STONE GREY	stone grey	stone grey
							866	NOCE PAVIA	STONE GREY	pavia walnut	stone grey
TAVOLO RIUNIONE L.120 x p.125,2 CON TOP ACCESS <i>meeting table w 120 x d 125,2 cms with top access</i>    L.120 x p.125,2 x H.73,6	L.120	148 575 (*)	49	0,184	4	€ 426,00					
VASCHETTA CENTRALE PASSACAVI <b>PER TAVOLO RIUNIONE ART.575</b> <i>central cable tray for meeting tables ART.575</i>    L.90 x p.20 x H.10	L.90	148 576 (*)	1,5	0,013	1	€ 54,00	(*)				
							000	ARGENTO		silver	
							440	BIANCO		white	
							844	STONE GREY		stone grey	

 ⇄ = VENATURA LEGNO  
 wood veining

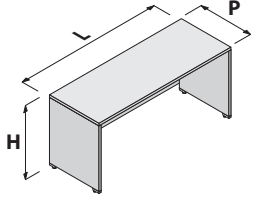
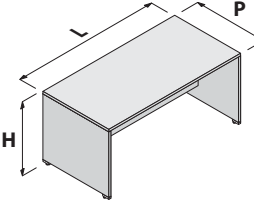
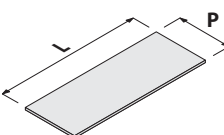
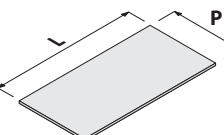
**VALIDO SOLO PER SCRIVANIE LINEARI!**  
**VALID FOR LINEAR DESKS ONLY!**

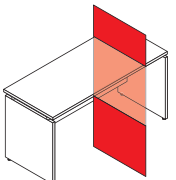
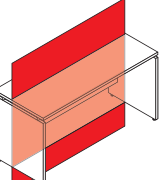
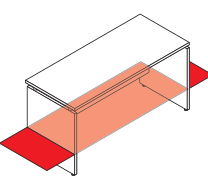
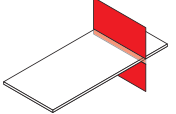
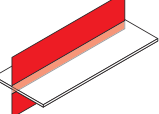
ARTICOLO ARTICLE	MAGGIORAZIONE PREZZO PRICE INCREASE						
SCRIVANIE PROF. CM 60 <i>desks depth 60 cms</i>  L. x <b>p.60</b> x H.73,6	<table border="1"> <tr><td>L.80</td></tr> <tr><td>L.100</td></tr> <tr><td>L.120</td></tr> <tr><td>L.140</td></tr> <tr><td>L.160</td></tr> <tr><td>L.180</td></tr> </table> <b>+ € 90,00</b>	L.80	L.100	L.120	L.140	L.160	L.180
L.80							
L.100							
L.120							
L.140							
L.160							
L.180							
SCRIVANIE PROF. CM 80 <i>desks depth 80 cms</i>  L. x <b>p.80</b> x H.73	<table border="1"> <tr><td>L.80</td></tr> <tr><td>L.100</td></tr> <tr><td>L.120</td></tr> <tr><td>L.140</td></tr> <tr><td>L.160</td></tr> <tr><td>L.180</td></tr> </table> <b>+ € 97,00</b>	L.80	L.100	L.120	L.140	L.160	L.180
L.80							
L.100							
L.120							
L.140							
L.160							
L.180							
PIANI SCRIVANIE PROF. CM 60 <i>desk tops depth 60 cms</i>  L. x <b>p.60</b> x H.2,5	<table border="1"> <tr><td>L.80</td></tr> <tr><td>L.100</td></tr> <tr><td>L.120</td></tr> <tr><td>L.140</td></tr> <tr><td>L.160</td></tr> <tr><td>L.180</td></tr> </table> <b>+ € 45,00</b>	L.80	L.100	L.120	L.140	L.160	L.180
L.80							
L.100							
L.120							
L.140							
L.160							
L.180							
PIANI SCRIVANIE PROF. CM 80 <i>desk tops depth 80 cms</i>  L. x <b>p.80</b> x H.2,5	<table border="1"> <tr><td>L.80</td></tr> <tr><td>L.100</td></tr> <tr><td>L.120</td></tr> <tr><td>L.140</td></tr> <tr><td>L.160</td></tr> <tr><td>L.180</td></tr> </table> <b>+ € 51,00</b>	L.80	L.100	L.120	L.140	L.160	L.180
L.80							
L.100							
L.120							
L.140							
L.160							
L.180							

RIDUZIONI POSSIBILI - POSSIBLE REDUCTIONS			
	L	P	H
SCRIVANIE - DESKS			
PIANI - DESKTOPS			 <b>NON E' CONSENTITO IT'S NOT PERMITTED</b>



**LA MAGGIORAZIONE DEL PREZZO E' VALIDA  
 ANCHE SU RIDUZIONI DIMENSIONALI MULTIPLE in L x P x H**  
*The price increase is also valid in multiple size reductions (L x P x H)*

**TIPOLOGIE PER CUI VA SEMPRE RICHIESTO IL PREVENTIVO  
 PRODUCTS THAT ALWAYS REQUIRE A SPECIAL QUOTATION**

I

- CASSETTIERE, CLASSIFICATORI, KIT CASSETTI
- ANTE CRISTALLO CON O SENZA TELAIO
- PARTI METALLICHE
- TOP DI FINITURA E FIANCHI FINALI
- SCRIVANIE CON PIANI SAGOMATI
- PIANI SAGOMATI
- TERMINALI, RACCORDI E PENISOLE PER SCRIVANIE
- PARTI DI SOSTEGNO IN METALLO (TRAVI, GAMBE METALLICHE, ECC...)
- SCHERMI DIVISORI FRONTALI E LATERALI
- PARETINE

**RIDUZIONI  
DIMENSIONALI**

- QUALSIASI MOBILE O SCRIVANIA DI DIMENSIONI ECCEDENTI QUELLE RIPORTATE A LISTINO!
- CAMBIO COLORE

**SU  
MISURA**

GB

- PEDESTALS, FILE-CABINETS, KIT DRAWERS
- GLASS DOORS WITH OR WITHOUT FRAME
- METAL ELEMENTS
- FINISH TOP AND FINAL SIDE PANELS
- DESKS WITH SHAPED SURFACE
- SHAPED TOPS
- TERMINALS, JOINING SEGMENTS AND DESK EXTENSIONS
- METAL SUPPORTS (BEAMS, METAL LEGS, ECC...)
- FRONT OR LATERAL DIVIDING SCREENS
- PARTITION PANELS

**SIZES  
REDUCTION**

- ALL CABINETS OR DESKS WITH DIMENSIONS EXCEEDING THOSE PROPOSED IN THE PRICE LIST!
- COLOR CHANGE

**CUSTOMIZED**

**SCRIVANIE E TAVOLI RIUNIONE CON FIANCHI LEGNO**

-I piani di lavoro sono realizzati in pannelli di particelle di legno sp. mm 25 nobilitati in melaminico e bordati perimetralmente in ABS mm 2 in tinta con la superficie e disponibili nei colori: ROVERE 03, NOCE PAVIA 06, GRIGIO 42, STONE GREY 44, BIANCO BR. 69.

-I fianchi sono realizzati in pannelli di particelle di legno sp. mm 25 nobilitati in melaminico e bordati perimetralmente in ABS mm 2 in tinta con la superficie e disponibili nei colori: ARGENTO GOLF 01, NOCE PAVIA 06, STONE GREY 44, BIANCO BR. 69.

-Le schiene sono realizzate in pannelli di particelle di legno sp. mm 18 nobilitati in melaminico e bordati perimetralmente in melaminico mm 0.4 in tinta con la superficie e disponibili nei colori: ARGENTO GOLF 01, NOCE PAVIA 06, STONE GREY 44, BIANCO BR. 69.

Tra i piani di lavoro e i fianchi delle scrivanie viene applicato un distanziale di spessore mm.4 realizzato in ABS.

I fianchi sono completi di scarpette in abs che permettono l'innesto di piedini regolabili.

I bench con fianchi legno hanno i piani dotati di sportellino apribile a 180° su tutta la lunghezza. Nella parte sottostante i piani, in corrispondenza degli sportellini, vengono montate delle vaschette metalliche, agganciate alle schiene, che permettono l'alloggiamento dei cavi.

**TAVOLO DA SALOTTO**

Costituito da: piano e basamento legno.

Piano realizzato con pannelli di particelle di legno di spessore mm 25 nobilitato in melaminico. I bordi perimetrali sono in ABS di spessore mm 2 in tinta con la superficie. Il piano è disponibile nei colori: ROVERE 03, NOCE PAVIA 06, GRIGIO 42, STONE GREY 44, BIANCO BR. 69.

Basamento legno realizzato con pannelli di particelle di legno spessore mm 25 per i fianchi, spessore mm 18 per la schiena, nobilitati in melaminico, rifiniti perimetralmente con bordo melaminico spessore mm 0,4 in tinta con la superficie. I fianchi sono dotati di piedini livellatori. Il basamento legno è disponibile nei colori: ARGENTO GOLF 01, NOCE PAVIA 06, STONE GREY 44, BIANCO BR. 69.

**TAVOLI RIUNIONE CIRCOLARI CON BASAMENTO A COLONNA**

Costituito da: piano e basamento metallico.

-Il piano è realizzato con pannello di particelle di legno sp. mm 25 nobilitati in melaminico e bordati perimetralmente in ABS mm 2 in tinta con la superficie e disponibili nei colori: ROVERE 03, NOCE PAVIA 06, GRIGIO 42, STONE GREY 44, BIANCO BR. 69.

-Basamento metallico composto da: base circolare Ø590mm, tubo verticale e crociera superiore.

Il tubo verticale ha una sezione che parte alla base con un Ø128mm e poi sale a un Ø89mm. La crociera è realizzata con lamiera metallica sp. mm 4 dotata di asole per il fissaggio sottopiano. Il basamento è verniciato a polveri epossidiche nei colori:

ARGENTO, BIANCO, STONE GREY.

**SCRIVANIE E TAVOLI RIUNIONE CON GAMBE METALLICHE A "T" SAGOMATE**

- I piani di lavoro sono realizzati in pannelli di particelle di legno sp. mm 25 nobilitati in melaminico e bordati perimetralmente in ABS mm 2 in tinta con la superficie e disponibili nei colori: ROVERE 03, NOCE PAVIA 06, GRIGIO 42, BIANCO BR. 69.

- Trave di sostegno orizzontale realizzata in lamiera metallica pressopiegata con sezione a "C" 46 x 58 x sp. mm 1,5, verniciata a polveri epossidiche nei colori: ARGENTO e BIANCO. E' dotata di asole per la salita dei cablaggi e fori per il fissaggio alle gambe metalliche e al piano. La sua forma consente direttamente l'alloggiamento dei cavi senza l'utilizzo di vaschette aggiuntive.

Viene fornita imballata con angolari in cartone e foglia di polietilene termoretraibile.

- Gambe metalliche a "T" realizzate in lamiera stampata e verniciata a polveri epossidiche disponibile nei colori: ARGENTO e BIANCO.

Dotate di viti per il fissaggio ai piani, piedini livellatori e di carter passacavi in pvc estruso alloggiato in apposita sede per la salita dei cablaggi. Vengono fornite imballate con angolari in cartone e foglia di polietilene termoretraibile.

**SCRIVANIE E TAVOLI RIUNIONE CON GAMBE METALLICHE A "T" SQUADRATE**

- I piani di lavoro sono realizzati in pannelli di particelle di legno sp. mm 25 nobilitati in melaminico e bordati perimetralmente in ABS mm 2 in tinta con la superficie e disponibili nei colori: ROVERE 03, NOCE PAVIA 06, STONE GREY 44, BIANCO BR. 69.

- Trave di sostegno orizzontale realizzata in lamiera metallica pressopiegata con sezione a "C" 46 x 58 x sp. mm 1,5, verniciata a polveri epossidiche nei colori: ARGENTO, BIANCO e STONE GREY. E' dotata di asole per la salita dei cablaggi e fori per il fissaggio alle gambe metalliche e al piano. La sua forma consente direttamente l'alloggiamento dei cavi senza l'utilizzo di vaschette aggiuntive.

Viene fornita imballata con angolari in cartone e foglia di polietilene termoretraibile.

- Gambe metalliche a "T" realizzate in tubolare (60 x 30 x 2 tubolare orizzontale/ 90 x 60 x 2 ritto verticale) verniciata a polveri epossidiche disponibile nei colori: ARGENTO, BIANCO e STONE GREY.

Dotate di viti per il fissaggio ai piani, piedini livellatori e di carter passacavi in pvc estruso alloggiato in apposita sede per la salita dei cablaggi, realizzato nello stesso colore della gamba. Viene fornita imballata con angolari in cartone e foglia di polietilene termoretraibile.

**SCRIVANIE e WORKSTATION CON GAMBE METALLICHE A "PONTE" A SEZIONE QUADRATA**

- I piani di lavoro sono realizzati in pannelli di particelle di legno sp. mm 25 nobilitati in melaminico e bordati perimetralmente in ABS mm 2 in tinta con la superficie e disponibili nei colori: ROVERE 03, NOCE PAVIA 06, GRIGIO 42, BIANCO BR. 69.

- Il basamento metallico a ponte è costituito da : 2 gambe a ponte e 2 travi longitudinali.

- Le travi hanno una lunghezza fissa e sono realizzate con tubolare metallico di sezione 50x15x1,5, nei colori ARGENTO e BIANCO.

Le gambe a ponte sono realizzate mediante tubolare metallico di sezione quadra di mm 50 x 50 sp. 2 verniciato a polveri epossidiche nei colori: ARGENTO e BIANCO. La parte orizzontale presenta fori per consentire il fissaggio del piano di lavoro e delle travi.

Tra i piani di lavoro e gambe metalliche viene applicato un distanziale di spessore mm.4 realizzato in ABS.

**SCRIVANIE e WORKSTATION CON GAMBE METALLICHE A "PONTE" A SEZIONE TRAPEZOIDALE**

- Il piano di lavoro è realizzato con pannello di particelle di legno sp. mm 25 nobilitato in melaminico e bordato perimetralmente in ABS mm 2 in tinta con la superficie E' disponibile nei colori: ROVERE 03, NOCE PAVIA 06, STONE GREY 44, BIANCO BR. 69.

- Il basamento metallico a ponte è costituito da : 2 gambe a ponte e 2 travi longitudinali.

- Le travi hanno una lunghezza fissa e sono realizzate con tubolare metallico di sezione 50x15x1,5 nei colori: ARGENTO, BIANCO e STONE GREY.

Sono dotate di fori che permettono il fissaggio della struttura ai piani tramite viti a passo metrico.

Le gambe a ponte sono realizzate in tubolare di acciaio trafilato a sezione trapezoidale, sp. mm 2 verniciate a polveri epossidiche nei colori: ARGENTO, BIANCO e STONE GREY. La parte orizzontale è costituita da tubolare metallico di sezione 50x20x1.5 e rimane arretrata rispetto alla parte a vista della gamba.

**TAVOLO RIUNIONE CON GAMBE METALLICHE A "PONTE" A SEZIONE TRAPEZOIDALE**

- Il piano di lavoro è realizzato con pannello di particelle di legno sp. mm 25 nobilitato in melaminico e bordato perimetralmente in ABS mm



2 in tinta con la superficie E' disponibile nei colori: ROVERE 03, NOCE PAVIA 06, STONE GREY 44, BIANCO BR. 69. Il piano è dotato di Top Access integrato, con cornice in plastica stampata colore argento e coperchio realizzato con pannello di particelle di legno sp. mm 8 dello stesso colore dei piani.

- Il basamento metallico a ponte è costituito da : 2 gambe a ponte e 4 travi longitudinali.

- Le travi hanno una lunghezza fissa e sono realizzate con tubolare metallico di sezione 50x15x1,5 nei colori ARGENTO, BIANCO e STONE GREY. Le gambe a ponte sono realizzate in tubolare di acciaio trafilato a sezione trapezoidale, sp. mm 2 verniciate a polveri epossidiche nei colori: ARGENTO, BIANCO e STONE GREY. La parte orizzontale è costituita da tubolare metallico di sezione 50x20x1.5 e rimane arretrata rispetto alla parte a vista della gamba.

### COMBY

Disponibili nelle versioni mono-facciali e bi-facciali e in due altezze: H. cm.109 e H. cm.160. Permettono l'aggregazione a scrivanie pannellate e metalliche a "T" e a ponte tramite staffe metalliche, dando la possibilità di realizzare composizioni singole e doppie.

La struttura è realizzata con pannelli di particelle legno sp. mm 25 nobilitati in melaminico, disponibile nei colori STONE GREY 44 e BIANCO BR. 69, rifinita perimetralmente con bordo in ABS mm 2 in tinta con la superficie.

Le ante scorrevoli del COMBY alto mono-facciale sono realizzate con pannello di particelle legno sp. mm 18 nobilitato in melaminico. I bordi perimetrali sono in ABS mm 2 in tinta con la superficie. Le maniglie sono in materiale plastico e di colore in tonalità con le ante. Sono dotate di serratura.

Il ripiano ad altezza scrivania e le ante scorrevoli sono disponibili nei colori: ROVERE 03, NOCE PAVIA 06, STONE GREY 44, BIANCO BR. 69.

Tutti i COMBY sono dotati di SALITA CAVI, una il mono-facciale e due il bi-facciale, realizzata in lamiera metallica pressopiegata sp. mm 0,8, verniciata a polveri epossidiche in tinta con la struttura.

I fianchi sono completi di scarpette in abs che permettono l'innesto di piedini registrabili.

### KIT STAFFE REGGIPIANO

Staffe realizzate in lamiera pressopiegata sp. mm 2 verniciate a polveri epossidiche nei colori : ARGENTO, BIANCO, STONE GREY, idonee a sostenere le scrivanie aggregabili.

### LIBRERIE PER COMBY

Struttura costituita da: base, cappello, due fianchi e ripiani di spessore mm.25, bordati perimetralmente in tinta con la superficie. La schiena ha spessore mm.18 e si inserisce in fresata.

Sono disponibili nei colori STONE GREY 44 e BIANCO BR. 69. Dotate di piedini livellatori

I fianchi sono completi di scarpette in abs che permettono l'innesto di piedini registrabili.

### CASSETTIERE BASI O LATERALI

Struttura realizzata con pannelli di particelle legno sp. mm 18 nobilitati in melaminico, disponibile nei colori: ARGENTO GOLF 01, NOCE PAVIA 06, STONE GREY 44, BIANCO BR. 69, rifinita perimetralmente con bordo melaminico mm 0.4. I frontali sono realizzati con pannello di particelle di legno sp. mm 18 nobilitato melaminico e disponibili nei colori: ROVERE 03, NOCE PAVIA 06, GRIGIO 42, STONE GREY 44, BIANCO BR. 69.

I bordi perimetrali sono in ABS mm 2 in tinta con la superficie. Maniglie con sagoma a "ponte", interasse mm 64 realizzate in polipropilene in tinta con i frontali.

I cassetti in legno sono dotati di serratura centralizzata, le spondine sono in fibre legnose sp. mm 12 rivestite in PVC nero, il fondo è in fibra dello spessore di mm 3. Le guide scorrevoli sono del tipo in metallo con cuscinetti in nylon dotati di fine corsa in estrazione e self-closing in chiusura. Le cassettiere vanno completate con top di finitura per l'accostamento ai piani di lavoro oppure utilizzate sotto i piani di lavoro come struttura portante.

### MOBILI LATERALI H 73,6 PER SCRIVANIE E WORKSTATION

Disponibili con larghezza L.60 e L.80, nelle versioni a giorno oppure con ante legno.

Struttura realizzata con pannelli di particelle legno sp. mm 18 nobilitati in melaminico, disponibile nei colori ARGENTO GOLF 01, NOCE PAVIA 06, STONE GREY 44, BIANCO BR. 69, rifinita perimetralmente con bordo melaminico mm 0.4.

Le ante, dotate di serratura, sono realizzate con pannello di particelle di legno sp. mm 18 nobilitato melaminico e disponibili nei colori: ROVERE 03, NOCE PAVIA 06, GRIGIO 42, STONE GREY 44, BIANCO BR. 69. I bordi perimetrali sono in ABS mm 2 in tinta con la superficie.

Maniglie con sagoma a "ponte", interasse mm 64 realizzate in polipropilene in tinta con i frontali.

Il mobile laterale deve essere sempre completato con il top di finitura sp. mm 25, fornito a parte, nello stesso colore dei piani di lavoro.

Può essere posto a fianco di scrivanie e workstation con profondità di piano cm 60 e 80.

### SOPRALZI PER MOBILI LATERALI

Disponibili con larghezza L.60 E L.80.

Fianchi e schiena realizzati con pannelli di particelle legno sp. mm 18 nobilitati in melaminico, rifiniti perimetralmente con bordo melaminico mm 0.4.

Top realizzato con pannello di particelle di legno sp. mm 25 nobilitato melaminico con bordi perimetrali sono in ABS mm 2 in tinta con la superficie.

I sopralzi sono disponibili nei colori: ARGENTO GOLF 01, ROVERE 03, NOCE PAVIA 06, GRIGIO 42, STONE GREY 44, BIANCO BR. 69.

### PANNELLI FRONTALI PER SCRIVANIE

Realizzati in pannelli di particelle di legno sp. mm 18 nobilitati in melaminico e bordati perimetralmente in ABS mm 2 in tinta con la superficie e disponibili nei colori: ARGENTO GOLF 01, STONE GREY 44, BIANCO BR. 69.

La parte superiore è dotata di binario in pvc, in tinta con il pannello, per consentire l'aggancio degli accessori. Si fissano ai piani mediante staffe metalliche in lamiera pressopiegata e verniciate a polveri epossidiche in tinta con le strutture metalliche.

### PANNELLI FRONTALI PER BENCH

Realizzati in pannelli di particelle di legno sp. mm 25 nobilitati in melaminico e bordati perimetralmente in ABS mm 2 in tinta con la superficie e disponibili nei colori: STONE GREY 44, BIANCO BR. 69. La parte superiore è dotata di binario in pvc colore grigio per consentire l'aggancio degli accessori.

Tutti i pannelli frontali vengono ancorati nello spazio longitudinale posto al centro dei bench tramite appositi morsetti realizzati in zama presso-fusa, e sono forniti completi di profilo di copertura dello spazio stesso costruiti in plastica co-estrusa in tinta con il pannello. Tale profilo, asportabile ed ispezionabile, assolve la funzione di top access integrato.

### VASCHETTE PASSACAVI PER BENCH

Realizzate in lamiera metallica sp. mm 1 verniciata a polveri epossidiche nei colori: STONE GREY 44, BIANCO BR. 69. Consentono l'alloggiamento di kit elettrificazione e la raccolta di cavi in eccesso. Il montaggio avviene con fissaggio sottopiano.

### TOP DI FINITURA, PIANI DI LAVORO LINEARI, WORKSTATION, PENISOLA E ANGOLO DI RACCORDO

Sono realizzati in pannelli di particelle di legno sp. mm 25 nobilitati in melaminico e bordati perimetralmente in ABS mm 2 in tinta con la superficie. Sono disponibili nei colori: ROVERE 03, NOCE PAVIA 06, GRIGIO 42, STONE GREY 44, BIANCO BR. 69.

### SCHIENE PER SCRIVANIE

Le schiene sono realizzate in pannelli di particelle di legno sp. mm 18 nobilitati in melaminico e bordati perimetralmente in melaminico mm 0.4 in tinta con la superficie e disponibili nei colori: ARGENTO GOLF 01, STONE GREY 44, BIANCO BR. 69.

Il montaggio avviene con staffe che si fissano sotto il piano di lavoro.

### PANNELLI PARETINA

Sono realizzati in pannelli di particelle di legno sp. mm 25 nobilitati in melaminico disponibili nei colori: ARGENTO GOLF 01, STONE GREY 44, BIANCO BR. 69.

I pannelli sono dotati lateralmente e nella parte superiore di profilo in PVC estruso, in tinta con la superficie, con cava attrezzabile per il supporto di accessori di complemento e tappi di testa in tinta con la superficie.

Nella parte a contatto con il pavimento sono inserite scarpette in abs che permettono l'innesto di piedini registrabili. L'unione dei pannelli avviene tramite profili di connessione in pvc realizzati in tinta con la superficie. Le derivazioni a due, tre, quattro vie si realizzano con montante di raccordo a sezione quadrata dotato di cave verticali al quale vengono ancorati i pannelli per mezzo del profilo di connessione lineare. Sono forniti con mensole reggipiano in abs di disegno esclusivo che hanno la funzione di sostegno in caso di collegamento con piani scrivania. Anche il montante è disponibile nei colori delle superfici.

### FIANCHI SOTTOPIANO

Realizzati con pannelli di particelle di legno sp. mm 25 nobilitati in melaminico e bordati perimetralmente in ABS mm 2 in tinta con la superficie. Sono disponibili nei colori: ARGENTO GOLF 01, STONE GREY 44, BIANCO BR. 69.

Il fissaggio con il piano di lavoro avviene tramite puntale metallico sottopiano e piastrelli in materiale plastico.

### SOPRALZI IN VETRO

Sono realizzati in vetro temperato sp. mm 5 TRASPARENTE e si innestano nel profilo superiore delle paretine.

### ACCESSORI PER PANNELLI FRONTALI E PARETINE

Accessori realizzati in lamiera metallica sp. mm 1, pressopiegata con tagli ed incisioni al laser e verniciata a polveri epossidiche.

Disponibili nei colori: ARGENTO, STONE GREY, BIANCO. Sono agganciabili sul profilo superiore dei pannelli frontali e delle paretine.

### KIT RIVESTIMENTI FONOASSORBENTI

Disponibili in 2 altezze.

H.28,7 per pannelli frontali bench su COMBY.

H.35,3 per pannelli frontali scrivanie, paretine, COMBY.

Realizzati con pannelli in schiumato stampato a freddo sp. mm 6, rivestiti in tessuto poliestere stretch ignifugo nei colori: AZZURRO SKY 320, GIALLO FRESIA 321, AMARANTO 322, VERDE BOSCO 323, TORTORA 328.

### IMBALLO

Tutti i componenti sono forniti smontati ed imballati con involucro pieghevole in cartone triplo, listelli di protezione perimetrale e per i riempimenti ove occorre. Gli angoli sono protetti, ove occorre, con parasigoli anti-urto. La chiusura dell'imballo avviene mediante nastro adesivo e reggetta in nylon termosaldato.

Le cassettiere sono fornite montate, protette sui lati con angolari in polistirolo ed imballate con foglia di polietilene termoretraibile.

CARATTERISTICHE FISICO-MECCANICHE DEI PANNELLI DI PARTICELLE DI LEGNO DI SPESSORE mm 18 NOBILITATI IN MELAMINICO:		
DESCRIZIONE	VALORE MINIMO	NORMA DI RIFERIMENTO
Massa volumica	650 Kg / m <sup>3</sup> ± 10%	UNI EN 323 :1994
Umidità relativa	5 - 13%	UNI EN 322 :1994
Tolleranza spessore	± 0,3 mm	UNI EN 324-1/1994
Rigonfiamento a 24 ore	15%	UNI EN 317 :1994
Distacco strati esterni	0,8 Mpa	UNI EN 311 :2003
Flessione statica	16 Mpa	UNI EN 310 :1994
Modulo di elasticità	1600 Mpa	UNI EN 310 :1994
Estrazione viti sui bordi	> 400 N	UNI EN 320 :1994
Contenuto di formaldeide	≤ a 3,5 mg H <sub>2</sub> CO (m <sup>2</sup> x h)	UNI EN ISO 12460 - 3:2015

Emesso da Ufficio Tecnico  
LAS MOBILI  
Data ultima revisione:  
GENNAIO 2018



## TECHNICAL DESCRIPTIONS

### DESKS, WORKSTATIONS AND MEETING TABLES WITH PANELS BASE:

- The work tops are in particleboards, thickness 25 mm, with melamine facing and edge-finishing in 2 mm ABS matching the main shade, available in the following colours: OAK 03, PAVIA WALNUT 06, GREY 42, STONE GREY 44, BR. WHITE 69.
  - The sides are in particleboards, thickness 25 mm, with melamine facing and edge-finishing in 2 mm ABS matching the main shade, available in the following colours: GOLF SILVER 01, PAVIA WALNUT 06, STONE GREY 44, BR. WHITE 69.
  - The backs are in particleboards, thickness 18 mm, with melamine facing and edge-finishing in 0.4 mm ABS matching the main shade, available in the following colours: GOLF SILVER 01, PAVIA WALNUT 06, STONE GREY 44, BR. WHITE 69.
- The sides are complete with abs liners that allow insertion of adjustable feet.  
Benches with wooden sides have tops equipped with a flap openable at 180° over the entire length. Under the tops in correspondence with the flaps metal cable trays are fixed to the modesty panels.

### COFFEE TABLE

Composed of: top and wooden base.

- Top made of particleboard panels 40mm thick that are melamine faced with wood pore finishing. The edge trim is 2mm ABS matching the surface. The top is available in colours: OAK 03, PAVIA WALNUT 06, GREY 42, STONE GREY 44, BR. WHITE 69
  - Wooden base made of 25 mm thick melamine faced particleboard panels for sides, 18 mm thick for back panel, finished with 0,4 mm melamine edging strip of the same shade as the surface. The side panels are equipped with adjustable feet.
- The wooden base is available in colours: GOLF SILVER 01, PAVIA WALNUT 06, STONE GREY 44, BR. WHITE 69.

### CIRCULAR MEETING TABLE WITH COLUMN BASE

Composed of: top and column base.

- The top is in particleboards, thickness 25 mm, with melamine facing and edge-finishing in 2 mm ABS matching the main shade, available in the following colours: OAK 03, PAVIA WALNUT 06, GREY 42, STONE GREY 44, BR. WHITE 69.
  - Metal base composed of: circular base Ø590mm, vertical column and upper plate.
- The column is made with a tube that has a section that starts at the base with a Ø128mm and then rises to a Ø 89mm. The top plate is made of sheet metal 4 mm thick with holes for fixing under the top. The metal base is painted with epoxy powder in colours: SILVER, WHITE, STONE GREY.

### DESKS, WORKSTATIONS AND MEETING TABLES WITH "T" SHAPED METAL LEGS AND FIXED CABLE-WAY BEAM

- The work tops are in particleboards, thickness 25 mm, with melamine facing and edge-finishing in 2 mm ABS matching the main shade, available in the following colours: OAK 03, PAVIA WALNUT 06, GREY 42, BR. WHITE 69.
  - "C" shaped support beam made from die-cast sheet metal with a section of dimensions 46 x 58 x thick.1,5 mm. It is painted with epoxy powder in colours : SILVER and WHITE. The beam has holes for the ascent of the wiring and for attachment to metal legs and tops. Its shape allows directly the cable housing without the use of additional trays. Supplied packaged with cardboard corners and thermo-retractable polyethylene sheet.
  - "T" shaped legs made from pressed steel and painted with epoxy powder in the following colours: SILVER and WHITE.
- It is supplied with fixing screws for the tops, levelling feet and carter cable management made from extruded PVC and fitted into a specific casing for ascent of the cables. Available in 2 versions: for 60cm and 80cm work top depths; can also be used in a central position between two contiguous tops. Supplied packaged with cardboard corners and thermo-retractable polyethylene sheet.

### DESKS, WORKSTATIONS AND MEETING TABLES WITH "T" SQUARED METAL LEGS AND FIXED CABLE-WAY BEAM

- The work tops are in particleboards, thickness 25 mm, with melamine facing and edge-finishing in 2 mm ABS matching the main shade, available in the following colours: OAK 03, PAVIA WALNUT 06, STONE GREY 44, BR. WHITE 69.
  - "C" shaped support beam made from die-cast sheet metal with a section of dimensions 46 x 58 x thick.1,5 mm. It is painted with epoxy powder in colours : SILVER, WHITE and STONE GREY. The beam has holes for the ascent of the wiring and for attachment to metal legs and tops. Its shape allows directly the cable housing without the use of additional trays. Supplied packaged with cardboard corners and thermo-retractable polyethylene sheet.
  - "T" shaped legs made from tubular steel (60 x 30 x 2/ 90 x 60 x 2) and painted with epoxy powder in the following colours: SILVER, WHITE and STONE GREY.
- It is supplied with fixing screws for the tops, levelling feet and carter cable management made from extruded PVC and fitted into a specific casing for ascent of the cables. Available in 2 versions: for 60cm and 80cm work top depths; can also be used in a central position between two contiguous tops.  
Supplied packaged with cardboard corners and thermo-retractable polyethylene sheet.

### DESKS AND WORKSTATIONS WITH "BRIDGE" METAL LEGS WITH SQUARED SECTION

- The work tops are in particleboards, thickness 25 mm, with melamine facing and edge-finishing in 2 mm ABS matching the main shade, available in the following colours: OAK 03, PAVIA WALNUT 06, GREY 42, BR. WHITE 69.
- The bridge leg steel base is made from: 2 bridge legs and 2 longitudinal beams.
- The beams have a unique length for all the desks. The beams are made with metal tubular with section 50x15x1,5mm.
  - The bridge legs are made from square tubular steel mm 50 x 50 sp. 2 painted with epoxy powder in the following colours: SILVER and WHITE. In the horizontal part there are holes , for fixing of the desk tops and the beams.

### DESKS AND WORKSTATIONS WITH "BRIDGE" METAL LEGS WITH TRAPEZOID SECTION

- The work tops are in particleboards, thickness 25 mm, with melamine facing and edge-finishing in 2 mm ABS matching the main shade, available in the following colours: OAK 03, PAVIA WALNUT 06, GREY 42, BR. WHITE 69.
- The bridge leg steel base is made from: 2 bridge legs and 2 longitudinal beams.
- The beams have a unique length for all the desks. The beams are made with metal tubular with section 50x15x1,5mm.
  - The bridge legs are made from trapezoid tubular steel , 2 mm thick, painted with epoxy powder in the following colours: SILVER ,WHITE, STONE GREY.
- In the horizontal part there are holes , for fixing of the desk tops and the beams.

### **MEETING TABLES WITH "BRIDGE" METAL LEGS WITH TRAPEZOID SECTION**

- The work top is in particleboards panel, thickness 25 mm, with melamine facing and edge-finishing in 2 mm ABS matching the main shade, available in the following colours: OAK 03, PAVIA WALNUT 06, GREY 42, BR. WHITE 69.

The work top is equipped with integrated Top Access, made of silver printed plastic frame and 8mm thick cover made of melamine faced particleboard panel in the same colour as the worktop surface.

The bridge leg steel base is made from: 2 bridge legs and 4 longitudinal beams.

- The beams have a unique length for all the desks. The beams are made with metal tubular with section 50x15x1,5mm.

- The bridge legs are made from trapezoid tubular steel, 2 mm thick painted with epoxy powder in the following colours: SILVER, WHITE, STONE GREY. In the horizontal part there are holes, for fixing of the desk tops and the beams.

### **COMBY**

Available in mono- and bi-facial versions in two height options: H. cm.109 e H. cm.160. They allow aggregation to paneled, metal T-shaped and bridge leg desks with use of metal stirrups. They allow creation of single and double configurations. The carcass is made of particleboards panel 25 mm thick, with melamine facing and edge-finishing in 2 mm ABS matching the main shade, available in the following colours: STONE GREY 44, BR. WHITE 69.

The sliding doors of high mono-facial COMBY are made of particleboards panel 18 mm thick, with melamine facing and edge-finishing in 2 mm ABS matching the main shade. The handles are made of plastic material matching the shade of the doors. They are equipped with a lock.

The shelves at desk height and the sliding doors are available in OAK 03, PAVIA WALNUT 06, STONE GREY 44, BR. WHITE 69.

All COMBY are provided with rising cable channels, one for mono-facial and two for bi-facial COMBY. The channels are made of bent metal sheet 0.8 mm thick painted with epoxy powder matching the carcass colour.

The sides are complete with ABS liners that allow insertion of adjustable feet.

### **STIRRUPS KIT FOR DESKTOPS**

Made of 2 mm thick die-cast sheet metal, epoxy powder coated in colours: SILVER, WHITE, STONE GREY.

### **BOOK CASE FOR COMBY**

Side panel and shelves are made of 25 mm thick particleboards faced with melamine. The back panel made of 18mm thick inserted into milling. Available in colours: STONE GREY 44 and BR. WHITE 69. Height-adjustable feet in nylon fixed under the side panel.

### **BASE OR LATERAL PEDESTALS**

Carcass made of particleboards, thickness 18 mm faced with melamine, available in colours: GOLF SILVER 01, PAVIA WALNUT 06, STONE GREY 44, BR. WHITE 69, edge-finishing in 0.4 mm thick melamine. The front panels and doors are in particleboards, thickness 18 mm with melamine facing, available in the following colours: OAK 03, PAVIA WALNUT 06, GREY 42, STONE GREY 44, BR. WHITE 69. Edge-finishing in 2 mm ABS of the same shade as the surface.

The wooden drawers are fitted with central locking, with side panels in wood fibre, thickness 12 mm faced with black PVC; the back is in fibre, thickness 3 mm.

The runner guides are in metal with nylon bearings with a pull-out end-stop and self-closing mechanism.

The pedestals are completed with finishing tops for matching with work tops or used underneath work tops as a load-bearing structure.

### **SIDE CABINETS - H 73,6 - FOR DESKS AND WORKSTATIONS:**

Two versions are available: open cabinet or with wooden doors.

Carcasses are made of particleboards, thickness 18 mm faced with melamine, available in colours: GOLF SILVER 01, PAVIA WALNUT 06, STONE GREY 44, BR. WHITE 69, edge-finishing in 0.4 mm thick melamine.

The doors, with lock, are in particleboards, thickness 18 mm with melamine facing, available in the following colours: OAK 03, PAVIA WALNUT 06, GREY 42, STONE GREY 44, BR. WHITE 69. Edge-finishing in 2 mm ABS of the same shade as the surface. Handles with "Bridge" shaped design, made of polypropylene.

The side cabinet must always be completed with a finishing top thickness 25 mm, to be ordered separately. It is available in the same shades as the surface of desktops.

Can be mounted as required by sides desks and workstations having shelf depths of 60 and 80 cm.

### **UPPER ELEMENT FOR SIDE CABINETS**

Sides and back panels are made with particleboards, thickness 18 mm faced with melamine, edge-finishing in 0,4 mm thick melamine.

Top made of particleboards, thickness 25 mm, with melamine facing and edge-finishing in 2 mm ABS matching the main shade.

The upper element for side cabinets is available in the following colours: GOLF SILVER 01, OAK 03, PAVIA WALNUT 06, GREY 42, STONE GREY 44, BR. WHITE 69. It can be mounted as required on desks and workstations having shelf depths of 60 and 80 cm.

### **FRONT PANELS**

In particleboards, thickness 18 mm, with melamine facing and edge-finishing in 2 mm ABS matching the main shade, available in the following colours: GOLF SILVER 01, STONE GREY 44, BR. WHITE 69. The upper section has grey PVC tracks for attaching the accessories.

The front panels are fixed with stirrups under the worktops.

### **FRONT PANELS FOR BENCHES**

Are made of 25 mm-thick melamine faced particleboard panel that are perimetrically bordered with 2mm-thick ABS that matches the top surface; available in the following colours: STONE GREY 44, BR. WHITE 69.

All front panels are anchored in the longitudinal space located at the centre of the benches using of special compression-molded zinc alloy clamps, and they are supplied complete with a covering profile and made of co-extruded plastic. This removable and inspectionable profile performs the integrated top access function.

There is an extruded plastic track, suitable for hanging accessories. on the upper side of the panel.

### **CABLE CHANNEL**

Optional, in sheet metal, thickness 1 mm, powder-painted in epoxy resin, for housing the "GS" electrification kit complete with SCHUCO

sockets and hiding excess cable lengths. Assembly by undertop fixing. Available colours: SILVER, STONE GREY, WHITE.

#### **FINISH TOP, DESKTOPS, WORKSTATION, TERMINAL AND JOINING SEGMENT**

The tops are in particleboards, thickness 25 mm, with melamine facing and edge-finishing in 2 mm ABS matching the main shade. The tops are available in the following colours: OAK 03, PAVIA WALNUT 06, GREY 42, STONE GREY 44, BR. WHITE 69.

#### **MODESTY PANELS FOR DESKS:**

The modesty panels are in particleboards, thickness 18 mm, with melamine facing and edge-finishing in 2 mm ABS matching the main shade, available in the following colours: GOLF SILVER 01, STONE GREY ,BR. WHITE 69. The modesty panels are fixed with stirrups under the worktops.

#### **PARTITION PANELS:**

Made of 25 mm thick particleboards melamine-faced available in the colours: GOLF SILVER 01, STONE GREY 44, BR. WHITE 69. The panels are fitted with lateral uprights in plastic coextruded, On the top part they are finished with an extruded PVC profile and head caps. Levelling feet are fitted on the part in contact with the floor. The linear connection of the panels is obtained by inserting a rigid PVC connection profile. The 2-3-4-way connections are made with a square upright.

#### **UNDERTOP SIDE PANEL:**

The side panel is in particleboards, thickness 25 mm, with melamine facing and edge-finishing in 2 mm ABS matching the main shade, available in the following colours: GOLF SILVER 01, STONE GREY 44, BR. WHITE 69. The fixing to the work tops is permitted by plastic elements of exclusive design which also provide a support function if connected to tops.

#### **ACCESSORIES**

All the accessories are made of 1 mm thick die-cast sheet metal, epoxy powder-coated in colours: SILVER, STONE GREY, WHITE. They can be fitted on the top profile of the front panel or partition panel.

#### **GLASS RAISED SECTION:**

5 mm thick TRANSPARENT tempered glass, attachable to the top slot of the partition panels.

#### **SOUND-PROOFING COVER KIT:**

Available in two height.

H.28,7 for front panels bench on COMBY.

H.35,3 for front panels for desktops, partition panels, COMBY.

They are made of polyurethane foam panels 6mm thick, covered with fire-retardant stretch polyester in colours: SKY BLUE 320, FREESIA YELLOW 321, AMARANTH 322, WOOD GREEN 323, GREY BEIGE 328.

#### **PACKAGING**

All the components are disassembled and packed when supplied, and have paper triple type folding packaging, fillets for the perimetrical protection and for the fillings up, where needed . The corners are protected, where needed, through shock resistant edges protector. The packing closure occurs through sticky tape and welded nylon strap.

Pedestals are assembled, protected through polystyrene angle bars on the sides and packed using thermo-retractable polyethylene sheet.

PHYSICAL-MECHANICAL CHARACTERISTICS OF 18 MM THICK PARTICLEBOARD PANELS, MELAMINE-FACED:		
DESCRIPTION	MINIMUM VALUE	STANDARD NUMBERS
Volume Mass	650 Kg / m <sup>3</sup> ± 10%	UNI EN 323 :1994
Relative Humidity	5 - 13%	UNI EN 322 :1994
Thickness Allowance	± 0,3 mm	UNI EN 324-1/1994
24 hour Swelling	15%	UNI EN 317 :1994
External Surfaces Detachment	0,8 Mpa	UNI EN 311 :2003
Static Flexure	16 Mpa	UNI EN 310 :1994
Elastic Modulus	1600 Mpa	UNI EN 310 :1994
Edge Screws Extraction	> 400 N	UNI EN 320 :1994
Formaldehyde Content	≤ a 3,5 mg H <sub>2</sub> CO (m <sup>2</sup> x h)	UNI EN ISO 12460 - 3:2015

Released by the Technical Office  
of LAS MOBILI  
last revision date:  
JANUARY 2018

**INDICE DEI CODICI**  
codes index

\* = INDICARE IL CODICE FINITURA  
= complete with finish code

INDICE DEI CODICI / codes index  
Mod. OXI

CODICE code	DESCRIZIONE description	PAG. page	PREZZO price
148 031 *	SCRIVANIA L.80 x p.60 desk w 80 x d 60 cms	11	€ 107,00
148 032 *	SCRIVANIA L.100 x p.60 desk w 100 x d 60 cms	11	€ 118,00
148 033 *	SCRIVANIA L.120 x p.60 desk w 120 x d 60 cms	11	€ 126,00
148 034 *	SCRIVANIA L.140 x p.60 desk w 140 x d 60 cms	11	€ 136,00
148 035 *	SCRIVANIA L.160 x p.60 desk w 160 x d 60 cms	11	€ 144,00
148 036 *	SCRIVANIA L.180 x p.60 desk w 180 x d 60 cms	11	€ 162,00
148 041 *	SCRIVANIA L.80 x p.80 desk w 80 x d 80 cms	11	€ 124,00
148 042 *	SCRIVANIA L.100 x p.80 desk w 100 x d 80 cms	11	€ 134,00
148 043 *	SCRIVANIA L.120 x p.80 desk w 120 x d 80 cms	11	€ 146,00
148 044 *	SCRIVANIA L.140 x p.80 desk w 140 x d 80 cms	11	€ 159,00
148 045 *	SCRIVANIA L.160 x p.80 desk w 160 x d 80 cms	11	€ 169,00
148 046 *	SCRIVANIA L.180 x p.80 desk w 180 x d 80 cms	11	€ 180,00
148 061 *	ALLUNGO LATERALE DX o SX PER SCRIVANIE right or left lateral extension for desks	11	€ 118,00
148 062 *	ALLUNGO LATERALE DX o SX PER CASSETTIERA-BASE right or left lateral extension for base-pedestal	11	€ 58,00
148 063 *	SCRIVANIA SAGOMATA L.160 x p.80 shaped desk w 160 x d 80 cms	11	€ 200,00
148 066 *	WORKSTATION L.160 x p.120 DX right workstation w 160 x d 120 cms	11	€ 270,00
148 067 *	WORKSTATION L.160 x p.120 SX left workstation w 160 x d 120 cms	11	€ 270,00
148 068 *	WORKSTATION SIMMETRICA L.140 x p.140 symmetrical workstation w 140 x d 140 cms	11	€ 271,00
148 080 *	SCRIVANIA L.80 x p.60 CON GAMBE METALLICHE A "T" SAGOMATE desk w 80 x d 60 cms with "T" shaped metal legs	12	€ 164,00
148 081 *	SCRIVANIA L.100 x p.60 CON GAMBE METALLICHE A "T" SAGOMATE desk w 100 x d 60 cms with "T" shaped metal legs	12	€ 175,00
148 082 *	SCRIVANIA L.120 x p.60 CON GAMBE METALLICHE A "T" SAGOMATE desk w 120 x d 60 cms with "T" shaped metal legs	12	€ 183,00
148 083 *	SCRIVANIA L.140 x p.60 CON GAMBE METALLICHE A "T" SAGOMATE desk w 140 x d 60 cms with "T" shaped metal legs	12	€ 193,00
148 084 *	SCRIVANIA L.160 x p.60 CON GAMBE METALLICHE A "T" SAGOMATE desk w 160 x d 60 cms with "T" shaped metal legs	12	€ 200,00
148 085 *	SCRIVANIA L.180 x p.60 CON GAMBE METALLICHE A "T" SAGOMATE desk w 180 x d 60 cms with "T" shaped metal legs	12	€ 219,00
148 087 *	SCRIVANIA L.80 x p.80 CON GAMBE METALLICHE A "T" SAGOMATE desk w 80 x d 80 cms with "T" shaped metal legs	12	€ 171,00
148 088 *	SCRIVANIA L.100 x p.80 CON GAMBE METALLICHE A "T" SAGOMATE desk w 100 x d 80 cms with "T" shaped metal legs	12	€ 181,00
148 089 *	SCRIVANIA L.120 x p.80 CON GAMBE METALLICHE A "T" SAGOMATE desk w 120 x d 80 cms with "T" shaped metal legs	12	€ 193,00
148 090 *	SCRIVANIA L.140 x p.80 CON GAMBE METALLICHE A "T" SAGOMATE desk w 140 x d 80 cms with "T" shaped metal legs	12	€ 206,00
148 091 *	SCRIVANIA L.160 x p.80 CON GAMBE METALLICHE A "T" SAGOMATE desk w 160 x d 80 cms with "T" shaped metal legs	12	€ 215,00
148 092 *	SCRIVANIA L.180 x p.80 CON GAMBE METALLICHE A "T" SAGOMATE desk w 180 x d 80 cms with "T" shaped metal legs	12	€ 227,00
148 093 *	ALLUNGO LATERALE DX o SX CON GAMBA METALLICA A "T" SAGOMATA E STAFFA right or left lateral extension with "T" shaped metal leg and stirrup	12	€ 130,00
148 094 *	SCRIVANIA SAGOMATA L.160 x p.80 CON GAMBE METALLICHE A "T" SAGOMATE shaped desk w 160 x d 80 cms with "T" shaped metal legs	12	€ 246,00
148 095 *	WORKSTATION L.160 x p.120 DX CON GAMBE METALLICHE A "T" SAGOMATE right workstation w 160 x d 120 cms with "T" shaped metal legs	12	€ 340,00
148 096 *	WORKSTATION L.160 x p.120 SX CON GAMBE METALLICHE A "T" SAGOMATE left workstation w 160 x d 120 cms with "T" shaped metal legs	12	€ 340,00
148 097 *	WORKSTATION L.160 x p.160 CON RIDUZIONE A DX E GAMBE METALLICHE A "T" SAGOMATE workstation w 160 x d 160 cms with right reduction and "T" shaped metal legs	12	€ 428,00
148 098 *	WORKSTATION L.160 x p.160 CON RIDUZIONE A SX E GAMBE METALLICHE A "T" SAGOMATE workstation w 160 x d 160 cms with left reduction and "T" shaped metal legs	12	€ 428,00
148 099 *	WORKSTATION SIMMETRICA L.140 x p.140 CON GAMBE METALLICHE A "T" SAGOMATE symmetrical workstation w 140 x d 140 cms with "T" shaped metal legs	12	€ 344,00
148 101 *	SCRIVANIA L.100 x p.60 CON GAMBE A PONTE desk w 100 x d 60 cms with bridge legs	13	€ 239,00
148 102 *	SCRIVANIA L.120 x p.60 CON GAMBE A PONTE desk w 120 x d 60 cms with bridge legs	13	€ 249,00
148 103 *	SCRIVANIA L.140 x p.60 CON GAMBE A PONTE desk w 140 x d 60 cms with bridge legs	13	€ 262,00
148 104 *	SCRIVANIA L.160 x p.60 CON GAMBE A PONTE desk w 160 x d 60 cms with bridge legs	13	€ 270,00
148 105 *	SCRIVANIA L.180 x p.60 CON GAMBE A PONTE desk w 180 x d 60 cms with bridge legs	13	€ 287,00

\* = INDICARE IL CODICE FINITURA  
= complete with finish code

INDICE DEI CODICI / codes index  
Mod. OXI

CODICE code	DESCRIZIONE description	PAG. page	PREZZO price
148 <b>106</b> *	SCRIVANIA L.100 x p.80 CON GAMBE A PONTE desk w 100 x d 80 cms with bridge legs	13	€ 257,00
148 <b>107</b> *	SCRIVANIA L.120 x p.80 CON GAMBE A PONTE desk w 120 x d 80 cms with bridge legs	13	€ 271,00
148 <b>108</b> *	SCRIVANIA L.140 x p.80 CON GAMBE A PONTE desk w 140 x d 80 cms with bridge legs	13	€ 287,00
148 <b>109</b> *	SCRIVANIA L.160 x p.80 CON GAMBE A PONTE desk w 160 x d 80 cms with bridge legs	13	€ 297,00
148 <b>110</b> *	SCRIVANIA L.180 x p.80 CON GAMBE A PONTE desk w 180 x d 80 cms with bridge legs	13	€ 307,00
148 <b>111</b> *	SCRIVANIA L.100 x p.80 CON GAMBA A PONTE INTERMEDIA desk w 100 x d 80 cms with central bridge leg	13-20	€ 168,00
148 <b>112</b> *	SCRIVANIA L.120 x p.80 CON GAMBA A PONTE INTERMEDIA desk w 120 x d 80 cms with central bridge leg	13-20	€ 182,00
148 <b>113</b> *	SCRIVANIA L.140 x p.80 CON GAMBA A PONTE INTERMEDIA desk w 140 x d 80 cms with central bridge leg	13-20	€ 198,00
148 <b>114</b> *	SCRIVANIA L.160 x p.80 CON GAMBA A PONTE INTERMEDIA desk w 160 x d 80 cms with central bridge leg	13-20	€ 208,00
148 <b>115</b> *	SCRIVANIA L.180 x p.80 CON GAMBA A PONTE INTERMEDIA desk w 180 x d 80 cms with central bridge leg	13-20	€ 218,00
148 <b>117</b> *	GAMBA A PONTE CON TRAVI A SBALZO bridge legs with overanjin beams	14	€ 112,00
148 <b>121</b> *	ALLUNGO L.100 CON GAMBA A PONTE extension w 100 cms with bridge leg	13	€ 151,00
148 <b>122</b> *	SCRIVANIA SAGOMATA L.160 x p.80 CON GAMBE A PONTE shaped desk w 160 x d 80 cms with bridge legs	13	€ 328,00
148 <b>123</b> *	SCRIVANIA SAGOMATA L.160 x p.80 CON GAMBA A PONTE INTERMEDIA shaped desk w 160 x d 80 cms with central bridge leg	13	€ 239,00
148 <b>127</b> *	WORKSTATION L.160 x p.120 DX CON GAMBE A PONTE right workstation w 160 x d 120 cms with bridge legs	14	€ 350,00
148 <b>128</b> *	WORKSTATION L.160 x p.120 SX CON GAMBE A PONTE left workstation w 160 x d 120 cms with bridge legs	14	€ 350,00
148 <b>129</b> *	GAMBA QUADRATA squared leg	14	€ 37,00
148 <b>148</b> *	COPIA PANNELLI DI TAMPONAMENTO WIRE-MANAGER PER GAMBA A PONTE INTERMEDIA set of 2 wire-manager panels for central bridge leg	15	€ 66,00
148 <b>150</b> *	GAMBA SINGOLA A "T" SQUADRATA PER PIANI PROF. CM 60 single "T" squared leg for desktop depth 60 cms	30	€ 66,00
148 <b>151</b> *	GAMBA SINGOLA A "T" SQUADRATA PER PIANI PROF. CM 80 single "T" squared leg for desktop depth 80 cms	30	€ 67,00
148 <b>170</b> *	SCRIVANIA L.80 x p.60 CON GAMBE METALLICHE A "T" SQUADRATE desk w 80 x d 60 cms with "T" squared metal legs	19	€ 186,00
148 <b>171</b> *	SCRIVANIA L.100 x p.60 CON GAMBE METALLICHE A "T" SQUADRATE desk w 100 x d 60 cms with "T" squared metal legs	19	€ 197,00
148 <b>172</b> *	SCRIVANIA L.120 x p.60 CON GAMBE METALLICHE A "T" SQUADRATE desk w 120 x d 60 cms with "T" squared metal legs	19	€ 205,00
148 <b>173</b> *	SCRIVANIA L.140 x p.60 CON GAMBE METALLICHE A "T" SQUADRATE desk w 140 x d 60 cms with "T" squared metal legs	19	€ 215,00
148 <b>174</b> *	SCRIVANIA L.160 x p.60 CON GAMBE METALLICHE A "T" SQUADRATE desk w 160 x d 60 cms with "T" squared metal legs	19	€ 222,00
148 <b>175</b> *	SCRIVANIA L.180 x p.60 CON GAMBE METALLICHE A "T" SQUADRATE desk w 180 x d 60 cms with "T" squared metal legs	19	€ 241,00
148 <b>176</b> *	SCRIVANIA L.80 x p.80 CON GAMBE METALLICHE A "T" SQUADRATE desk w 80 x d 80 cms with "T" squared metal legs	19	€ 195,00
148 <b>177</b> *	SCRIVANIA L.100 x p.80 CON GAMBE METALLICHE A "T" SQUADRATE desk w 100 x d 80 cms with "T" squared metal legs	19	€ 205,00
148 <b>178</b> *	SCRIVANIA L.120 x p.80 CON GAMBE METALLICHE A "T" SQUADRATE desk w 120 x d 80 cms with "T" squared metal legs	19	€ 217,00
148 <b>179</b> *	SCRIVANIA L.140 x p.80 CON GAMBE METALLICHE A "T" SQUADRATE desk w 140 x d 80 cms with "T" squared metal legs	19	€ 230,00
148 <b>180</b> *	SCRIVANIA L.160 x p.80 CON GAMBE METALLICHE A "T" SQUADRATE desk w 160 x d 80 cms with "T" squared metal legs	19	€ 239,00
148 <b>181</b> *	SCRIVANIA L.180 x p.80 CON GAMBE METALLICHE A "T" SQUADRATE desk w 180 x d 80 cms with "T" squared metal legs	19	€ 251,00
148 <b>183</b> *	ALLUNGO LATERALE DX o SX CON GAMBA METALLICA A "T" SQUADRATA E STAFFA right or left lateral extension with "T" squared metal leg and stirrup	19	€ 141,00
148 <b>185</b> *	SCRIVANIA SAGOMATA L.160 x p.80 CON GAMBE METALLICHE A "T" SQUADRATE shaped desk w 160 x d 80 cms with "T" squared metal legs	19	€ 270,00
148 <b>186</b> *	WORKSTATION L.160 x p.120 DX CON GAMBE METALLICHE A "T" SQUADRATE right workstation w 160 x d 120 cms with "T" squared metal legs	19	€ 375,00
148 <b>187</b> *	WORKSTATION L.160 x p.120 SX CON GAMBE METALLICHE A "T" SQUADRATE left workstation w 160 x d 120 cms with "T" squared metal legs	19	€ 375,00
148 <b>188</b> *	WORKSTATION L.160 x p.160 CON RIDUZIONE A DX E GAMBE METALLICHE A "T" SQUADRATE workstation w 160 x d 160 cms with right reduction and "T" squared metal legs	19	€ 463,00
148 <b>189</b> *	WORKSTATION L.160 x p.160 CON RIDUZIONE A SX E GAMBE METALLICHE A "T" SQUADRATE workstation w 160 x d 160 cms with left reduction and "T" squared metal legs	19	€ 463,00
148 <b>190</b> *	WORKSTATION SIMMETRICA L.140 x p.140 CON GAMBE METALLICHE A "T" SQUADRATE symmetrical workstation w 140 x d 140 cms with "T" squared metal legs	19	€ 377,00
148 <b>200</b> *	PANNELLO FRONTALE L.60 front panel w 60 cms	37	€ 38,00
148 <b>201</b> *	PANNELLO FRONTALE L.80 front panel w 80 cms	37	€ 44,00
148 <b>202</b> *	PANNELLO FRONTALE L.100 front panel w 100 cms	37	€ 50,00

\* = INDICARE IL CODICE FINITURA  
= complete with finish code

INDICE DEI CODICI / codes index  
Mod. OXI

CODICE code	DESCRIZIONE description	PAG. page	PREZZO price
148 203 *	PANNELLO FRONTALE L.120 front panel w 120 cms	37	€ 55,00
148 204 *	PANNELLO FRONTALE L.140 front panel w 140 cms	37	€ 61,00
148 205 *	PANNELLO FRONTALE L.160 front panel w 160 cms	37	€ 68,00
148 209 *	COPERTURA CENTRALE PASSACAVI PER BENCH L.120 cable way central cover for bench w 120 cms	36	€ 35,00
148 210 *	COPERTURA CENTRALE PASSACAVI PER BENCH L.140 cable way central cover for bench w 140 cms	36	€ 37,00
148 211 *	COPERTURA CENTRALE PASSACAVI PER BENCH L.160 cable way central cover for bench w 160 cms	36	€ 39,00
148 212 *	COPERTURA CENTRALE PASSACAVI PER BENCH L.180 cable way central cover for bench w 180 cms	36	€ 42,00
148 215 *	SCRIVANIA L.100 x p.60 CON GAMBE A PONTE TRAPEZOIDALI desk w 100 x d 60 cms with trapezoid bridge legs	20	€ 260,00
148 216 *	SCRIVANIA L.120 x p.60 CON GAMBE A PONTE TRAPEZOIDALI desk w 120 x d 60 cms with trapezoid bridge legs	20	€ 270,00
148 217 *	SCRIVANIA L.140 x p.60 CON GAMBE A PONTE TRAPEZOIDALI desk w 140 x d 60 cms with trapezoid bridge legs	20	€ 283,00
148 218 *	SCRIVANIA L.160 x p.60 CON GAMBE A PONTE TRAPEZOIDALI desk w 160 x d 60 cms with trapezoid bridge legs	20	€ 291,00
148 219 *	SCRIVANIA L.180 x p.60 CON GAMBE A PONTE TRAPEZOIDALI desk w 180 x d 60 cms with trapezoid bridge legs	20	€ 308,00
148 221 *	SCRIVANIA L.100 x p.80 CON GAMBE A PONTE TRAPEZOIDALI desk w 100 x d 80 cms with trapezoid bridge legs	20	€ 272,00
148 222 *	SCRIVANIA L.120 x p.80 CON GAMBE A PONTE TRAPEZOIDALI desk w 120 x d 80 cms with trapezoid bridge legs	20	€ 286,00
148 223 *	SCRIVANIA L.140 x p.80 CON GAMBE A PONTE TRAPEZOIDALI desk w 140 x d 80 cms with trapezoid bridge legs	20	€ 302,00
148 224 *	SCRIVANIA L.160 x p.80 CON GAMBE A PONTE TRAPEZOIDALI desk w 160 x d 80 cms with trapezoid bridge legs	20	€ 312,00
148 225 *	SCRIVANIA L.180 x p.80 CON GAMBE A PONTE TRAPEZOIDALI desk w 180 x d 80 cms with trapezoid bridge legs	20	€ 322,00
148 233 *	ALLUNGO L.100 CON GAMBA A PONTE TRAPEZOIDALE extension w 100 cms with trapezoid bridge leg	20	€ 181,00
148 234 *	SCRIVANIA SAGOMATA L.160 x p.80 CON GAMBE A PONTE TRAPEZOIDALI shaped desk w 160 x d 80 cms with trapezoid bridge legs	20	€ 343,00
148 237 *	WORKSTATION L.160 x p.120 DX CON GAMBE A PONTE TRAPEZOIDALI right workstation w 160 x d 120 cms with trapezoid bridge legs	21	€ 365,00
148 238 *	WORKSTATION L.160 x p.120 SX CON GAMBE A PONTE TRAPEZOIDALI left workstation w 160 x d 120 cms with trapezoid bridge legs	21	€ 365,00
148 241 *	SCRIVANIA PIANO IN VETRO L.160 x p.80 CON GAMBE A PONTE TRAPEZOIDALI glass desk w 160 x d 80 cms with trapezoid bridge legs	21	€ 535,00
148 242 *	SCRIVANIA PIANO IN VETRO L.180 x p.80 CON GAMBE A PONTE TRAPEZOIDALI glass desk w 180 x d 80 cms with trapezoid bridge legs	21	€ 570,00
148 243 *	ALLUNGO PIANO IN VETRO L.100 CON GAMBA A PONTE TRAPEZOIDALE glass extension w 100 cms with trapezoid bridge leg	21	€ 306,00
148 247 *	SCHIENA L.140 PER SCRIVANIA VETRO modesty panel w 140 cms for glass desk	21	€ 48,00
148 248 *	SCHIENA L.160 PER SCRIVANIA VETRO modesty panel w 160 cms for glass desk	21	€ 51,00
148 255 *	PANNELLO FRONTALE L.100 SOLO PER BENCH SU COMBY front panel w 100 cms for bench on comby only	36	€ 86,00
148 256 *	PANNELLO FRONTALE L.120 SOLO PER BENCH SU COMBY front panel w 120 cms for bench on comby only	36	€ 97,00
148 257 *	PANNELLO FRONTALE L.140 SOLO PER BENCH SU COMBY front panel w 140 cms for bench on comby only	36	€ 105,00
148 258 *	PANNELLO FRONTALE L.160 SOLO PER BENCH SU COMBY front panel w 160 cms for bench on comby only	36	€ 113,00
148 259 *	PANNELLO FRONTALE L.180 SOLO PER BENCH SU COMBY front panel w 180 cms for bench on comby only	36	€ 124,00
148 260 *	BENCH L.120 x p.165,2 CON BASAMENTO LEGNO bench w 120 x d 165,2 cms with panel base	22	€ 510,00
148 261 *	BENCH L.140 x p.165,2 CON BASAMENTO LEGNO bench w 140 x d 165,2 cms with panel base	22	€ 554,00
148 262 *	BENCH L.160 x p.165,2 CON BASAMENTO LEGNO bench w 160 x d 165,2 cms with panel base	22	€ 618,00
148 263 *	BENCH L.180 x p.165,2 CON BASAMENTO LEGNO bench w 180 x d 165,2 cms with panel base	22	€ 661,00
148 265 *	BENCH L.120 x p.165,2 CON FIANCHI INTERMEDI bench w 120 x d 165,2 cms with central panels	22	€ 474,00
148 266 *	BENCH L.140 x p.165,2 CON FIANCHI INTERMEDI bench w 140 x d 165,2 cms with central panels	22	€ 518,00
148 267 *	BENCH L.160 x p.165,2 CON FIANCHI INTERMEDI bench w 160 x d 165,2 cms with central panels	22	€ 582,00
148 268 *	BENCH L.180 x p.165,2 CON FIANCHI INTERMEDI bench w 180 x d 165,2 cms with central panels	22	€ 625,00
148 275 *	STAFFA PER PENISOLA E ANGOLO stirrup for terminal and joining segment	42	€ 15,00
148 310 *	VASCHETTA PASSACAVI PER COMBY cable-tray for comby	24	€ 16,00
148 311 *	SALITA CAVI PER COMBY rising cable tray for comby	24	€ 12,00



\* = INDICARE IL CODICE FINITURA  
= complete with finish code

INDICE DEI CODICI / codes index  
Mod. OXI

CODICE code	DESCRIZIONE description	PAG. page	PREZZO price
148 312 *	STAFFA DI ATTACCO PIANI 60 SU COMBY DX right stirrup for desk top depth 60 cms	25	€ 45,00
148 313 *	STAFFA DI ATTACCO PIANI 60 SU COMBY SX left stirrup for desk top depth 60 cms	25	€ 45,00
148 319 *	SCRIVANIA L.120 x p.60 CON FIANCO LEGNO PER COMBY desk w 120 x d 60 cms with side panel for comby	26	€ 116,00
148 320 *	SCRIVANIA L.140 x p.60 CON FIANCO LEGNO PER COMBY desk w 140 x d 60 cms with side panel for comby	26	€ 123,00
148 321 *	SCRIVANIA L.160 x p.60 CON FIANCO LEGNO PER COMBY desk w 160 x d 60 cms with side panel for comby	26	€ 128,00
148 322 *	SCRIVANIA L.180 x p.60 CON FIANCO LEGNO PER COMBY desk w 180 x d 60 cms with side panel for comby	26	€ 143,00
148 323 *	SCRIVANIA L.120 x p.80 CON FIANCO LEGNO PER COMBY desk w 120 x d 80 cms with side panel for comby	26	€ 178,00
148 324 *	SCRIVANIA L.140 x p.80 CON FIANCO LEGNO PER COMBY desk w 140 x d 80 cms with side panel for comby	26	€ 188,00
148 325 *	SCRIVANIA L.160 x p.80 CON FIANCO LEGNO PER COMBY desk w 160 x d 80 cms with side panel for comby	26	€ 195,00
148 326 *	SCRIVANIA L.180 x p.80 CON FIANCO LEGNO PER COMBY desk w 180 x d 80 cms with side panel for comby	26	€ 203,00
148 327 *	SCRIVANIA SAGOMATA L.160 x p.80 CON FIANCO LEGNO PER COMBY shaped desk w 160 x d 80 cms with side panel for comby	26	€ 226,00
148 328 *	SCRIVANIA CON STORAGE L.120 x p.80 PER COMBY desk with storage w 120 x d 80 cms for comby	26	€ 552,00
148 329 *	SCRIVANIA CON STORAGE L.140 x p.80 PER COMBY desk with storage w 140 x d 80 cms for comby	26	€ 562,00
148 330 *	SCRIVANIA CON STORAGE L.160 x p.80 PER COMBY desk with storage w 160 x d 80 cms for comby	26	€ 569,00
148 331 *	SCRIVANIA CON STORAGE L.180 x p.80 PER COMBY desk with storage w 180 x d 80 cms for comby	26	€ 577,00
148 333 *	COMBY MONO-FACCIALE H.109,3 single-side comby h.109,3	23	€ 295,00
148 334 *	COMBY MONO-FACCIALE H.160 CON 2 ANTE SCORREVOLI CON SERRATURA single-side comby h.160 with 2 sliding doors with lock	23	€ 604,00
148 338 *	COMBY BI-FACCIALE H.109,3 double-side comby h.109,3	23	€ 294,00
148 339 *	COMBY BI-FACCIALE H.160 double-side comby h.160	23	€ 442,00
148 341 *	LIBRERIA H.109,3 bookcase h.109,3	24	€ 120,00
148 342 *	LIBRERIA H.160 bookcase h.160	24	€ 160,00
148 347 *	CANALE PORTACAVI LAMIERA METALLICA PER BENCH L.120 cable channels in metal sheet for bench w 120 cms	36	€ 39,00
148 348 *	CANALE PORTACAVI LAMIERA METALLICA PER BENCH L.140 cable channels in metal sheet for bench w 140 cms	36	€ 48,00
148 349 *	CANALE PORTACAVI LAMIERA METALLICA PER BENCH L.160 cable channels in metal sheet for bench w 160 cms	36	€ 55,00
148 350 *	CANALE PORTACAVI LAMIERA METALLICA PER BENCH L.180 cable channels in metal sheet for bench w 180 cms	36	€ 63,00
148 353 *	SCRIVANIA L.120 x p.60 CON GAMBA METALLICA A "T" SQUADRATA PER COMBY desk w 120 x d 60 cms with "T" squared metal leg for comby	27	€ 147,00
148 354 *	SCRIVANIA L.140 x p.60 CON GAMBA METALLICA A "T" SQUADRATA PER COMBY desk w 140 x d 60 cms with "T" squared metal leg for comby	27	€ 157,00
148 355 *	SCRIVANIA L.160 x p.60 CON GAMBA METALLICA A "T" SQUADRATA PER COMBY desk w 160 x d 60 cms with "T" squared metal leg for comby	27	€ 164,00
148 356 *	SCRIVANIA L.180 x p.60 CON GAMBA METALLICA A "T" SQUADRATA PER COMBY desk w 180 x d 60 cms with "T" squared metal leg for comby	27	€ 183,00
148 363 *	SCRIVANIA L.120 x p.80 CON GAMBA METALLICA A "T" SQUADRATA PER COMBY desk w 120 x d 80 cms with "T" squared metal leg for comby	27	€ 205,00
148 364 *	SCRIVANIA L.140 x p.80 CON GAMBA METALLICA A "T" SQUADRATA PER COMBY desk w 140 x d 80 cms with "T" squared metal leg for comby	27	€ 218,00
148 365 *	SCRIVANIA L.160 x p.80 CON GAMBA METALLICA A "T" SQUADRATA PER COMBY desk w 160 x d 80 cms with "T" squared metal leg for comby	27	€ 227,00
148 366 *	SCRIVANIA L.180 x p.80 CON GAMBA METALLICA A "T" SQUADRATA PER COMBY desk w 180 x d 80 cms with "T" squared metal leg for comby	27	€ 239,00
148 367 *	SCRIVANIA SAGOMATA L.160 x p.80 CON GAMBA METALLICA A "T" SQUADRATA PER COMBY shaped desk w 160 x d 80 cms with "T" squared metal leg for comby	27	€ 258,00
148 372 *	SCRIVANIA L.120 x p.60 CON GAMBA A PONTE TRAPEZOIDALE PER COMBY desk w 120 x d 60 cms with trapezoid bridge leg for comby	27	€ 184,00
148 373 *	SCRIVANIA L.140 x p.60 CON GAMBA A PONTE TRAPEZOIDALE PER COMBY desk w 140 x d 60 cms with trapezoid bridge leg for comby	27	€ 197,00
148 374 *	SCRIVANIA L.160 x p.60 CON GAMBA A PONTE TRAPEZOIDALE PER COMBY desk w 160 x d 60 cms with trapezoid bridge leg for comby	27	€ 205,00
148 375 *	SCRIVANIA L.180 x p.60 CON GAMBA A PONTE TRAPEZOIDALE PER COMBY desk w 180 x d 60 cms with trapezoid bridge leg for comby	27	€ 222,00
148 377 *	SCRIVANIA L.120 x p.80 CON GAMBA A PONTE TRAPEZOIDALE PER COMBY desk w 120 x d 80 cms with trapezoid bridge leg for comby	27	€ 244,00
148 378 *	SCRIVANIA L.140 x p.80 CON GAMBA A PONTE TRAPEZOIDALE PER COMBY desk w 140 x d 80 cms with trapezoid bridge leg for comby	27	€ 260,00
148 379 *	SCRIVANIA L.160 x p.80 CON GAMBA A PONTE TRAPEZOIDALE PER COMBY desk w 160 x d 80 cms with trapezoid bridge leg for comby	27	€ 270,00
148 380 *	SCRIVANIA L.180 x p.80 CON GAMBA A PONTE TRAPEZOIDALE PER COMBY desk w 180 x d 80 cms with trapezoid bridge leg for comby	27	€ 280,00

\* = INDICARE IL CODICE FINITURA  
= complete with finish code

INDICE DEI CODICI / codes index  
Mod. OXI

CODICE code	DESCRIZIONE description	PAG. page	PREZZO price
148 381 *	SCRIVANIA SAGOMATA L.160 x p.80 CON GAMBA A PONTE TRAPEZOIDALE PER COMBY shaped desk w 160 x d 80 cms with trapezoid bridge leg for comby	27	€ 301,00
148 384 *	BENCH L.120 x p.125,2 CON GAMBA A PONTE TRAPEZOIDALE PER COMBY bench w 120 x d 125,2 cms with trapezoid bridge leg for comby	28	€ 396,00
148 385 *	BENCH L.140 x p.125,2 CON GAMBA A PONTE TRAPEZOIDALE PER COMBY bench w 140 x d 125,2 cms with trapezoid bridge leg for comby	28	€ 422,00
148 386 *	BENCH L.160 x p.125,2 CON GAMBA A PONTE TRAPEZOIDALE PER COMBY bench w 160 x d 125,2 cms with trapezoid bridge leg for comby	28	€ 438,00
148 387 *	BENCH L.180 x p.125,2 CON GAMBA A PONTE TRAPEZOIDALE PER COMBY bench w 180 x d 125,2 cms with trapezoid bridge leg for comby	28	€ 472,00
148 390 *	BENCH L.120 x p.165,2 CON GAMBA A PONTE TRAPEZOIDALE PER COMBY bench w 120 x d 165,2 cms with trapezoid bridge leg for comby	28	€ 427,00
148 391 *	BENCH L.140 x p.165,2 CON GAMBA A PONTE TRAPEZOIDALE PER COMBY bench w 140 x d 165,2 cms with trapezoid bridge leg for comby	28	€ 459,00
148 392 *	BENCH L.160 x p.165,2 CON GAMBA A PONTE TRAPEZOIDALE PER COMBY bench w 160 x d 165,2 cms with trapezoid bridge leg for comby	28	€ 479,00
148 393 *	BENCH L.180 x p.165,2 CON GAMBA A PONTE TRAPEZOIDALE PER COMBY bench w 180 x d 165,2 cms with trapezoid bridge leg for comby	28	€ 499,00
148 396 *	CASSETTIERA-BASE O LATERALE 4 CASSETTI + SERR. (CON CHIUSURA AMMORTIZZATA) PROF. CM 60 base or lateral pedestal with 4 drawers + lock (with soft-close) depth 60 cms	32	€ 209,00
148 397 *	CASSETTIERA-BASE O LATERALE CLASSIFICATORE + SERR. (CON CHIUSURA AMMORTIZZATA) PROF. CM 60 base or lateral pedestal with file drawer + lock (with soft-close) depth 60 cms	32	€ 225,00
148 398 *	CASSETTIERA-BASE O LATERALE 4 CASSETTI + SERR. (CON CHIUSURA AMMORTIZZATA) PROF. CM 80 base or lateral pedestal with 4 drawers + lock (with soft-close) depth 80 cms	32	€ 233,00
148 399 *	CASSETTIERA-BASE O LATERALE CLASSIFICATORE + SERR. (CON CHIUSURA AMMORTIZZATA) PROF. CM 80 base or lateral pedestal with file drawer + lock (with soft-close) depth 80 cms	32	€ 249,00
148 401 *	TOP PER CASSETTIERA LATERALE PROF. CM 60 finishing top for lateral pedestal deep 60 cms	32	€ 21,00
148 402 *	TOP PER CASSETTIERA LATERALE PROF. CM 80 finishing top for lateral pedestal deep 80 cms	32	€ 28,00
148 404 *	BENCH L.120 x p.125,2 CON FIANCO LEGNO PER COMBY bench w 120 x d 125,2 cms with side panel for comby	28	€ 322,00
148 405 *	BENCH L.140 x p.125,2 CON FIANCO LEGNO PER COMBY bench w 140 x d 125,2 cms with side panel for comby	28	€ 336,00
148 406 *	BENCH L.160 x p.125,2 CON FIANCO LEGNO PER COMBY bench w 160 x d 125,2 cms with side panel for comby	28	€ 346,00
148 407 *	BENCH L.180 x p.125,2 CON FIANCO LEGNO PER COMBY bench w 180 x d 125,2 cms with side panel for comby	28	€ 376,00
148 408 *	BENCH L.120 x p.165,2 CON FIANCO LEGNO PER COMBY bench w 120 x d 165,2 cms with side panel for comby	28	€ 359,00
148 409 *	BENCH L.140 x p.165,2 CON FIANCO LEGNO PER COMBY bench w 140 x d 165,2 cms with side panel for comby	28	€ 379,00
148 410 *	BENCH L.160 x p.165,2 CON FIANCO LEGNO PER COMBY bench w 160 x d 165,2 cms with side panel for comby	28	€ 393,00
148 411 *	BENCH L.180 x p.165,2 CON FIANCO LEGNO PER COMBY bench w 180 x d 165,2 cms with side panel for comby	28	€ 409,00
148 415 *	PARETINA L.60 x H.109,3 partition panel w 60 x h.109,3 cms	47	€ 101,00
148 416 *	PARETINA L.80 x H.109,3 partition panel w 80 x h.109,3 cms	47	€ 116,00
148 417 *	PARETINA L.100 x H.109,3 partition panel w 100 x h.109,3 cms	47	€ 137,00
148 418 *	PARETINA L.120 x H.109,3 partition panel w 120 x h.109,3 cms	47	€ 158,00
148 419 *	PARETINA L.140 x H.109,3 partition panel w 140 x h.109,3 cms	47	€ 174,00
148 420 *	PARETINA L.160 x H.109,3 partition panel w 160 x h.109,3 cms	47	€ 190,00
148 421 *	PARETINA L.180 x H.109,3 partition panel w 180 x h.109,3 cms	47	€ 207,00
148 425 *	PARETINA CENTRALE L.60 x H.109,3 central partition panel w 60 x h.109,3 cms	47	€ 107,00
148 426 *	PARETINA CENTRALE L.80 x H.109,3 central partition panel w 80 x h.109,3 cms	47	€ 121,00
148 427 *	PARETINA CENTRALE L.100 x H.109,3 central partition panel w 100 x h.109,3 cms	47	€ 143,00
148 428 *	PARETINA CENTRALE L.120 x H.109,3 central partition panel w 120 x h.109,3 cms	47	€ 166,00
148 429 *	PARETINA CENTRALE L.140 x H.109,3 central partition panel w 140 x h.109,3 cms	47	€ 182,00
148 430 *	PARETINA CENTRALE L.160 x H.109,3 central partition panel w 160 x h.109,3 cms	47	€ 198,00
148 431 *	PARETINA CENTRALE L.180 x H.109,3 central partition panel w 180 x h.109,3 cms	47	€ 215,00
148 450 *	PARETINA L.60 x H.135 partition panel w 60 x h.135 cms	47	€ 118,00
148 451 *	PARETINA L.80 x H.135 partition panel w 80 x h.135 cms	47	€ 137,00
148 452 *	PARETINA L.100 x H.135 partition panel w 100 x h.135 cms	47	€ 156,00
148 453 *	PARETINA L.120 x H.135 partition panel w 120 x h.135 cms	47	€ 182,00
148 455 *	PARETINA CENTRALE L.60 x H.135 central partition panel w 60 x h.135 cms	47	€ 123,00

\* = INDICARE IL CODICE FINITURA  
= complete with finish code

INDICE DEI CODICI / codes index  
Mod. OXI

CODICE code	DESCRIZIONE description	PAG. page	PREZZO price
148 456 *	PARETINA CENTRALE L.80 x H.135 central partition panel w 80 x h.135 cms	47	€ 142,00
148 457 *	PARETINA CENTRALE L.100 x H.135 central partition panel w 100 x h.135 cms	47	€ 162,00
148 458 *	PARETINA CENTRALE L.120 x H.135 central partition panel w 120 x h.135 cms	47	€ 190,00
148 460 *	PARETINA L.140 x H.135 partition panel w 140 x h.135 cms	47	€ 201,00
148 461 *	PARETINA L.160 x H.135 partition panel w 160 x h.135 cms	47	€ 221,00
148 462 *	PARETINA L.180 x H.135 partition panel w 180 x h.135 cms	47	€ 240,00
148 463 *	PARETINA CENTRALE L.140 x H.135 central partition panel w 140 x h.135 cms	47	€ 210,00
148 464 *	PARETINA CENTRALE L.160 x H.135 central partition panel w 160 x h.135 cms	47	€ 229,00
148 465 *	PARETINA CENTRALE L.180 x H.135 central partition panel w 180 x h.135 cms	47	€ 248,00
148 467 *	STAFFA PER COLLEGAMENTO CASSETTIERA-BASE A PENISOLE O ANGOLI DI RACCORDO stirrup for connection base-pedestal to terminals or joining segments	33	€ 15,00
148 468 *	PARETINA L.60 x H.160 partition panel w 60 x h.160 cms	48	€ 134,00
148 469 *	PARETINA L.70 x H.160 partition panel w 70 x h.160 cms	48	€ 145,00
148 470 *	PARETINA L.80 x H.160 partition panel w 80 x h.160 cms	48	€ 157,00
148 471 *	PARETINA L.90 x H.160 partition panel w 90 x h.160 cms	48	€ 168,00
148 472 *	PARETINA L.100 x H.160 partition panel w 100 x h.160 cms	48	€ 180,00
148 473 *	PARETINA L.120 x H.160 partition panel w 120 x h.160 cms	48	€ 203,00
148 474 *	PARETINA CENTRALE L.60 x H.160 central partition panel w 60 x h.160 cms	48	€ 139,00
148 475 *	PARETINA CENTRALE L.70 x H.160 central partition panel w 70 x h.160 cms	48	€ 150,00
148 476 *	PARETINA CENTRALE L.80 x H.160 central partition panel w 80 x h.160 cms	48	€ 162,00
148 477 *	PARETINA CENTRALE L.90 x H.160 central partition panel w 90 x h.160 cms	48	€ 173,00
148 478 *	PARETINA CENTRALE L.100 x H.160 central partition panel w 100 x h.160 cms	48	€ 185,00
148 479 *	PARETINA CENTRALE L.120 x H.160 central partition panel w 120 x h.160 cms	48	€ 212,00
148 480 *	GAMBA A PONTE TRAPEZOIDALE PROF. CM 60 CON TRAVI A SBALZO trapezoid bridge leg depth 60 cms with overanging beams	21-50	€ 116,00
148 481 *	GAMBA A PONTE TRAPEZOIDALE PROF. CM 80 CON TRAVI A SBALZO trapezoid bridge leg depth 80 cms with overanging beams	50	€ 119,00
148 483 *	FIANCO TERMINALE PER PARETINA L.60 terminal side partition panel w 60	50	€ 60,00
148 484 *	FIANCO TERMINALE PER PARETINA L.80 terminal side partition panel w 80	50	€ 65,00
148 486 *	MONTANTE DI RACCORDO 2-3-4 VIE H.109,3 joining stanchion 2-3-4 ways H.109,3 cms	48	€ 26,00
148 487 *	MONTANTE DI RACCORDO 2-3-4 VIE H.135 joining stanchion 2-3-4 ways H.135 cms	48	€ 27,00
148 488 *	MONTANTE DI RACCORDO 2-3-4 VIE H.160 joining stanchion 2-3-4 ways H.160 cms	48	€ 28,00
148 491 *	PROFILO TERMINALE PER PARETINA (OPTIONAL) H.109,3 terminal profile for partition panel (optional) H.109,3	49	€ 8,00
148 492 *	PROFILO TERMINALE PER PARETINA (OPTIONAL) H.135 terminal profile for partition panel (optional) H.135	49	€ 9,00
148 493 *	PROFILO TERMINALE PER PARETINA (OPTIONAL) H.160 terminal profile for partition panel (optional) H.160	49	€ 10,00
148 498 *	STAFFA PER ALLUNGO LATERALE ART.544 stirrup for lateral extension art.544	40	€ 16,00
148 499 *	2 FIANCHI SOTTOPIANO CENTRALI PER PARETINE 2 central undertop panels for partitions	50	€ 109,00
148 501 *	VASCHETTA PASSACAVI L.49 cable-tray w 49 cms	49	€ 26,00
148 502 *	VASCHETTA PASSACAVI L.59 cable-tray w 59 cms	49	€ 27,00
148 503 *	VASCHETTA PASSACAVI L.69 cable-tray w 69 cms	49	€ 28,00
148 504 *	VASCHETTA PASSACAVI L.79 cable-tray w 79 cms	49	€ 30,00
148 505 *	VASCHETTA PASSACAVI L.89 cable-tray w 89 cms	49	€ 31,00
148 506 *	VASCHETTA PASSACAVI L.109 cable-tray w 109 cms	49	€ 34,00
148 507 *	VASCHETTA PASSACAVI L.129 cable-tray w 129 cms	49	€ 37,00
148 508 *	VASCHETTA PASSACAVI L.149 cable-tray w 149 cms	49	€ 41,00

\* = INDICARE IL CODICE FINITURA  
= complete with finish code

INDICE DEI CODICI / codes index  
Mod. OXI

CODICE code	DESCRIZIONE description	PAG. page	PREZZO price
148 509 *	VASCETTA PASSACAVI L.169 cable-tray w 169 cms	49	€ 44,00
148 511 *	GAMBA SINGOLA A"TT" SAGOMATA PER PIANI PROF. CM 60 single "T" shaped leg for desktop depth 60 cms	17	€ 55,00
148 512 *	GAMBA SINGOLA A"TT" SAGOMATA PER PIANI PROF. CM 80 single "T" shaped leg for desktop depth 80 cms	17	€ 55,00
148 524 *	TRAVE A SBALZO PER PENISOLE, ALLUNGO DATTOLO E ANGOLI DI RACCORDO overranging beam for extensions, typist desk's terminal and joining segments	17	€ 17,00
148 525 *	2 PIASTRINI+KIT ELETTRIFICAZIONE SINGOLO CON PRESE SCHUKO E CAVO DI ALIMENTAZIONE DI MT 2,00 2 plates+single electrification kit with SCHUKO sockets and power cable of w 200 cms	17	€ 91,00
148 526 *	TRAVE CANALIZZATA PER SCRIVANIA L.80 cable-way beam for desk w 80 cms	17	€ 21,00
148 527 *	TRAVE CANALIZZATA PER SCRIVANIA L.100 cable-way beam for desk w 100 cms	17	€ 23,00
148 528 *	TRAVE CANALIZZATA PER SCRIVANIA L.120 cable-way beam for desk w 120 cms	17	€ 26,00
148 529 *	TRAVE CANALIZZATA PER SCRIVANIA L.140 cable-way beam for desk w 140 cms	17	€ 29,00
148 530 *	TRAVE CANALIZZATA PER SCRIVANIA L.160 cable-way beam for desk w 160 cms	17	€ 31,00
148 531 *	TRAVE CANALIZZATA PER SCRIVANIA L.180 cable-way beam for desk w 180 cms	17	€ 35,00
148 533 *	PIANO SCRIVANIA L.80 x p.80 desk top w 80 x d 80 cms	41	€ 40,00
148 534 *	PIANO SCRIVANIA L.100 x p.80 desk top w 100 x d 80 cms	41	€ 48,00
148 535 *	PIANO SCRIVANIA L.120 x p.80 desk top w 120 x d 80 cms	41	€ 57,00
148 536 *	PIANO SCRIVANIA L.140 x p.80 desk top w 140 x d 80 cms	41	€ 67,00
148 537 *	PIANO SCRIVANIA L.160 x p.80 desk top w 160 x d 80 cms	41	€ 74,00
148 538 *	PIANO SCRIVANIA L.180 x p.80 desk top w 180 x d 80 cms	41	€ 82,00
148 543 *	PIANO SCRIVANIA L.80 x p.60 desk top w 80 x d 60 cms	40	€ 33,00
148 544 *	PIANO SCRIVANIA L.100 x p.60 O ALLUNGO LATERALE desk top w 100 x d 60 cms or lateral extension	40	€ 42,00
148 545 *	PIANO SCRIVANIA L.120 x p.60 desk top w 120 x d 60 cms	40	€ 47,00
148 546 *	PIANO SCRIVANIA L.140 x p.60 desk top w 140 x d 60 cms	40	€ 54,00
148 547 *	PIANO SCRIVANIA L.160 x p.60 desk top w 160 x d 60 cms	40	€ 59,00
148 548 *	PIANO SCRIVANIA L.180 x p.60 desk top w 180 x d 60 cms	40	€ 74,00
148 549 *	PIANO SCRIVANIA SAGOMATA L.160 x p.80 shaped desk top w 160 x d 80 cms	41	€ 105,00
148 550 *	PIANO WORKSTATION L.160 x p.120 CON RIDUZIONE A DX workstation top w 160 x d 120 cms with right reduction	41	€ 127,00
148 551 *	PIANO WORKSTATION L.160 x p.120 CON RIDUZIONE A SX workstation top w 160 x d 120 cms with left reduction	41	€ 127,00
148 552 *	PIANO WORKSTATION L.160 x p.160 CON RIDUZIONE A DX workstation top w 160 x d 160 cms with right reduction	41	€ 215,00
148 553 *	PIANO WORKSTATION L.160 x p.160 CON RIDUZIONE A SX workstation top w 160 x d 160 cms with left reduction	41	€ 215,00
148 554 *	PIANO WORKSTATION SIMMETRICA L.140 x p.140 CON LATI PROF. CM 60 symmetrical workstation top w 140 x d 140 cms with deep sides 60 cms	41	€ 133,00
148 555 *	ESTENSIONE L.60 extension w 60 cms	41	€ 53,00
148 556 *	ESTENSIONE L.80 extension w 80 cms	41	€ 59,00
148 558 *	PENISOLA SEMICIRCOLARE PER SCRIVANIA PROF. CM 80 semicircular terminal for desk deep 80 cms	42	€ 85,00
148 559 *	ANGOLO DI RACCORDO 90° PER SCRIVANIE PROF. CM 80/80 90° segment for desks deep 80/80 cms	42	€ 67,00
148 563 *	TAVOLO DA SALOTTO L.60 coffee table w 60 cms	53	€ 130,00
148 566 *	TAVOLO RIUNIONE RETTANGOLARE L.210 x p.100 CON BASAMENTO LEGNO rectangular meeting table w 210 x d 100 cms with panels base	53	€ 204,00
148 567 *	TAVOLO RIUNIONE RETTANGOLARE L.260 x p.100 CON BASAMENTO LEGNO rectangular meeting table w 260 x d 100 cms with panels base	53	€ 245,00
148 568 *	TAVOLO RIUNIONE CIRCOLARE Ø 80 CM CON BASAMENTO METALLICO round meeting table Ø 80 cms with metal base	54	€ 356,00
148 569 *	TAVOLO RIUNIONE CIRCOLARE Ø 100 CM CON BASAMENTO METALLICO round meeting table Ø 100 cms with metal base	54	€ 381,00
148 570 *	TAVOLO RIUNIONE CIRCOLARE Ø 120 CM CON BASAMENTO METALLICO round meeting table Ø 120 cms with metal base	54	€ 403,00
148 571 *	TAVOLO RIUNIONE RETTANGOLARE L.210 x p.100 CON GAMBE A "TT" SAGOMATE rectangular meeting table w 210 x d 100 cms with "T" shaped metal legs	54	€ 246,00
148 572 *	TAVOLO RIUNIONE RETTANGOLARE L.260 x p.100 CON GAMBE A "TT" SAGOMATE rectangular meeting table w 260 x d 100 cms with "T" shaped metal legs	54	€ 289,00
148 573 *	TAVOLO RIUNIONE RETTANGOLARE L.210 x p.100 CON GAMBE A "TT" SQUADRATE rectangular meeting table w 210 x d 100 cms with "T" squared metal legs	54	€ 270,00

\* = INDICARE IL CODICE FINITURA  
= complete with finish code

INDICE DEI CODICI / codes index  
Mod. OXI

CODICE code	DESCRIZIONE description	PAG. page	PREZZO price
148 574 *	TAVOLO RIUNIONE RETTANGOLARE L.260 x p.100 CON GAMBE A "T" SQUADRATE rectangular meeting table w 260 x d 100 cms with "T" squared metal legs	54	€ 313,00
148 575 *	TAVOLO RIUNIONE L.120 x p.125,2 CON TOP ACCESS E GAMBE A PONTE TRAPEZOIDALI meeting table w 120 x d 125,2 cms with top access and trapezoid bridge legs	54	€ 426,00
148 576 *	VASCHETTA CENTRALE PASSACAVI PER TAVOLO RIUNIONE ART.575 central cable-tray for meeting table art.575	54	€ 54,00
148 590 *	SOPRALZO IN VETRO TEMPERATO L.60 raised tempered glass unit w 60 cms	51	€ 41,00
148 591 *	SOPRALZO IN VETRO TEMPERATO L.70 raised tempered glass unit w 70 cms	51	€ 42,00
148 592 *	SOPRALZO IN VETRO TEMPERATO L.80 raised tempered glass unit w 80 cms	51	€ 44,00
148 593 *	SOPRALZO IN VETRO TEMPERATO L.90 raised tempered glass unit w 90 cms	51	€ 46,00
148 594 *	SOPRALZO IN VETRO TEMPERATO L.100 raised tempered glass unit w 100 cms	51	€ 48,00
148 595 *	SOPRALZO IN VETRO TEMPERATO L.120 raised tempered glass unit w 120 cms	51	€ 50,00
148 596 *	SOPRALZO IN VETRO TEMPERATO L.140 raised tempered glass unit w 140 cms	51	€ 54,00
148 597 *	SOPRALZO IN VETRO TEMPERATO L.160 raised tempered glass unit w 160 cms	51	€ 57,00
148 598 *	SOPRALZO IN VETRO TEMPERATO L.180 raised tempered glass unit w 180 cms	51	€ 60,00
148 657 *	STAFFA PER GAMBA ART.151 stirrup for leg art.151	50	€ 8,00
148 659 *	STAFFA DI RINFORZO SOTTO-PIANO PER ESTENSIONI undertop stirrup for extensions	40-41	€ 23,00
148 666 *	MOBILE LATERALE A GIORNO L.60 Side open cabinet w 60 cms	34	€ 87,00
148 667 *	MOBILE LATERALE L.60 CON 1 ANTA LEGNO DX CON SERR. Side cabinet w 60 cms with 1 right wooden door with lock	34	€ 130,00
148 668 *	MOBILE LATERALE L.60 CON 1 ANTA LEGNO SX CON SERR. Side cabinet w 60 cms with 1 left wooden door with lock	34	€ 130,00
148 669 *	MOBILE LATERALE A GIORNO L.80 Side open cabinet w 80 cms	35	€ 100,00
148 671 *	MOBILE LATERALE L.80 CON 2 ANTE LEGNO CON SERR. Side cabinet w 80 cms with 2 wooden doors with lock	35	€ 161,00
148 672 *	TOP PER MOBILE SCRIVANIA L.60 CON VENATURA TRASVERSALE top for desk cabinet w 60 cms with transversal wood veining	34	€ 28,00
148 673 *	TOP PER MOBILE SCRIVANIA L.80 CON VENATURA TRASVERSALE top for desk cabinet w 80 cms with transversal wood veining	35	€ 31,00
148 676 *	TOP PER MOBILE SCRIVANIA L.60 top for desk cabinet w 60 cms	34	€ 28,00
148 677 *	TOP PER MOBILE SCRIVANIA L.80 top for desk cabinet w 80 cms	35	€ 31,00
148 678 *	SOPRALZO PER MOBILE LATERALE L.60 upper element for side cabinet w 60 cms	34	€ 46,00
148 679 *	SOPRALZO PER MOBILE LATERALE L.80 upper element for side cabinet w 80 cms	35	€ 55,00
148 685 *	SCHIENA L.60 modesty panel w 60 cms	39	€ 29,00
148 686 *	SCHIENA L.80 modesty panel w 80 cms	39	€ 32,00
148 687 *	SCHIENA L.100 modesty panel w 100 cms	39	€ 35,00
148 688 *	SCHIENA L.120 modesty panel w 120 cms	39	€ 39,00
148 689 *	SCHIENA L.140 modesty panel w 140 cms	39	€ 42,00
148 690 *	SCHIENA L.160 modesty panel w 160 cms	39	€ 45,00
148 900 *	KIT RIVESTIMENTO FONOASSORBENTE PER 1 LATO L.60 sound-proofing fabric cover for a side w 60 cms	37-51	€ 34,00
148 901 *	KIT RIVESTIMENTO FONOASSORBENTE PER 1 LATO L.80 sound-proofing fabric cover for a side w 80 cms	37-51	€ 43,00
148 902 *	KIT RIVESTIMENTO FONOASSORBENTE PER 1 LATO L.100 sound-proofing fabric cover for a side w 100 cms	37-51	€ 58,00
148 903 *	KIT RIVESTIMENTO FONOASSORBENTE PER 1 LATO L.120 sound-proofing fabric cover for a side w 120 cms	37-51	€ 64,00
148 904 *	KIT RIVESTIMENTO FONOASSORBENTE PER 1 LATO L.140 sound-proofing fabric cover for a side w 140 cms	37-51	€ 75,00
148 905 *	KIT RIVESTIMENTO FONOASSORBENTE PER 1 LATO L.160 sound-proofing fabric cover for a side w 160 cms	23-37-51	€ 82,00
148 906 *	KIT RIVESTIMENTO FONOASSORBENTE PER 1 LATO L.180 sound-proofing fabric cover for a side w 180 cms	37-51	€ 93,00
148 909 *	KIT RIVESTIMENTO FONOASSORBENTE PER 2 LATI L.100 sound-proofing fabric cover for double sides w 100 cms	36	€ 111,00
148 910 *	KIT RIVESTIMENTO FONOASSORBENTE PER 2 LATI L.120 sound-proofing fabric cover for double sides w 120 cms	36	€ 122,00
148 911 *	KIT RIVESTIMENTO FONOASSORBENTE PER 2 LATI L.140 sound-proofing fabric cover for double sides w 140 cms	36	€ 142,00
148 912 *	KIT RIVESTIMENTO FONOASSORBENTE PER 2 LATI L.160 sound-proofing fabric cover for double sides w 160 cms	36	€ 158,00

\* = INDICARE IL CODICE FINITURA  
= complete with finish code

INDICE DEI CODICI / codes index  
Mod. OXI

CODICE code	DESCRIZIONE description	PAG. page	PREZZO price
148 913 *	KIT RIVESTIMENTO FONOASSORBENTE PER 2 LATI L.180 sound-proofing fabric cover for double sides w 180 cms	36	€ 181,00
148 914 *	KIT RIVESTIMENTO FONOASSORBENTE PER 1 LATO L.70 sound-proofing fabric cover for a side w 70 cms	51	€ 39,00
148 927 *	1 GANCIO 1 hook	38-52	€ 24,00
148 928 *	PORTA-FIORE CON PROVETTA flower-holder with tube	38-52	€ 29,00
148 929 *	PORTA-BOTTIGLIA bottle-holder	38-52	€ 28,00
148 930 *	PORTA-PENNE pen-holder	38-52	€ 28,00
148 931 *	PORTA-CELLULARE smartphone-holder	38-52	€ 30,00
148 932 *	PORTA-TABLET tablet-holder	38-52	€ 35,00
148 933 *	LAVAGNA METALLICA metallic board	38-52	€ 35,00
148 934 *	PORTA-CARTA A4 A4 paper-holder	38-52	€ 35,00
148 940 *	BENCH L.120 x p.125,2 CON GAMBE A PONTE bench w 120 x d 125,2 cms with bridge legs	15	€ 406,00
148 941 *	BENCH L.140 x p.125,2 CON GAMBE A PONTE bench w 140 x d 125,2 cms with bridge legs	15	€ 432,00
148 942 *	BENCH L.160 x p.125,2 CON GAMBE A PONTE bench w 160 x d 125,2 cms with bridge legs	15	€ 448,00
148 943 *	BENCH L.180 x p.125,2 CON GAMBE A PONTE bench w 180 x d 125,2 cms with bridge legs	15	€ 482,00
148 945 *	BENCH L.120 x p.125,2 CON GAMBA A PONTE INTERMEDIA bench w 120 x d 125,2 cms with central bridge leg	15	€ 296,00
148 946 *	BENCH L.140 x p.125,2 CON GAMBA A PONTE INTERMEDIA bench w 140 x d 125,2 cms with central bridge leg	15	€ 322,00
148 947 *	BENCH L.160 x p.125,2 CON GAMBA A PONTE INTERMEDIA bench w 160 x d 125,2 cms with central bridge leg	15	€ 338,00
148 948 *	BENCH L.180 x p.125,2 CON GAMBA A PONTE INTERMEDIA bench w 180 x d 125,2 cms with central bridge leg	15	€ 372,00
148 955 *	BENCH L.120 x p.165,2 CON GAMBE A PONTE bench w 120 x d 165,2 cms with bridge legs	15	€ 487,00
148 956 *	BENCH L.140 x p.165,2 CON GAMBE A PONTE bench w 140 x d 165,2 cms with bridge legs	15	€ 519,00
148 957 *	BENCH L.160 x p.165,2 CON GAMBE A PONTE bench w 160 x d 165,2 cms with bridge legs	15	€ 539,00
148 958 *	BENCH L.180 x p.165,2 CON GAMBE A PONTE bench w 180 x d 165,2 cms with bridge legs	15	€ 559,00
148 960 *	BENCH L.120 x p.165,2 CON GAMBA A PONTE INTERMEDIA bench w 120 x d 165,2 cms with central bridge leg	15	€ 330,00
148 961 *	BENCH L.140 x p.165,2 CON GAMBA A PONTE INTERMEDIA bench w 140 x d 165,2 cms with central bridge leg	15	€ 362,00
148 962 *	BENCH L.160 x p.165,2 CON GAMBA A PONTE INTERMEDIA bench w 160 x d 165,2 cms with central bridge leg	15	€ 382,00
148 963 *	BENCH L.180 x p.165,2 CON GAMBA A PONTE INTERMEDIA bench w 180 x d 165,2 cms with central bridge leg	15	€ 402,00
152 759 *	KIT 4 GHIERE DI COPERTURA FORO Ø 60 MM PER PARETINE set of 4 cable way Ø 60 MM for partition panel	48	€ 18,00
175 106 *	3 PRESE STANDARD ITALIA/GERMANIA SCHUKO+ 2 RJ45 CAT.6 + 2 USB 3 Italy/Germany SCHUKO standard sockets+2 RJ45 CAT. 6 + 2 USB	Y3	€ 144,00
175 107 *	3 PRESE STANDARD FRANCIA + 2 RJ45 CAT. 6 + 2 USB 3 France standard sockets+2 RJ45 CAT. 6 + 2 USB	Y3	€ 144,00
175 117 *	2 PRESE STANDARD ITALIA/GERMANIA SCHUKO+ 2 CHARGER USB + 1 TAPPO 2 Italy/Germany SCHUKO standard sockets+2 charger USB + 1 cap	K1	€ 257,00
175 118 *	2 PRESE STANDARD FRANCIA+ 2 CHARGER USB + 1 TAPPO 2 FRANCE standard sockets+2 charger USB + 1 cap	K1	€ 243,00
175 119 *	2 PRESE STANDARD INGLESI+ 2 CHARGER USB + 1 TAPPO 2 BRITISH standard sockets+2 charger USB + 1 cap	K1	€ 270,00
175 120 *	2 PRESE STANDARD ITALIA/GERMANIA SCHUKO+ 2 CHARGER USB + 1 TAPPO 2 Italy/Germany SCHUKO standard sockets+2 charger USB + 1 cap	K2	€ 317,00
175 121 *	2 PRESE STANDARD FRANCIA+ 2 CHARGER USB + 1 TAPPO 2 FRANCE standard sockets+2 charger USB + 1 cap	K2	€ 285,00
175 122 *	2 PRESE STANDARD INGLESI+ 2 CHARGER USB + 1 TAPPO 2 BRITISH standard sockets+2 charger USB + 1 cap	K2	€ 343,00
175 123 *	1 RJ45 CAT.6	42	€ 39,00
175 124 *	2 RJ45 CAT.6	42	€ 73,00
175 125 *	1 RJ45 CAT.6 + 1 HDMI	42	€ 73,00



LISTINO 2018  
PRICE LIST

5<sup>TH</sup> ELEMENT

# 5<sup>TH</sup> ELEMENT

Design  
STUDIO SI

Engineering  
C.S.R. LAS MOBILI

- > Executive
- > Desking-Bench
- > System
- > Elementi comuni/shared elements
- > Meeting



## IMPORTANTE / it's very important

SULL'ORDINE INDICARE SEMPRE IL CODICE COMPLETO A 9 CIFRE  
always indicate on the order the complete 9-digit code

ESEMPIO: PER ORDINARE 1 PIANO **ART.380** ROVERE INDICARE IL CODICE =  
example: to order 1 DESKTOP **ART.380** OAK indicate the code =

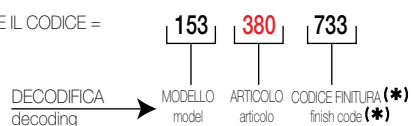

In vigore dal:  
Valid from:  
01/01/2018

Valido fino a nuova emissione  
Valid until new emission

## Executive

<b>CARTELLA COLORI</b> .....	<b>5</b>
<i>colours samples card</i>	

<b>ABBINAMENTI COLORI</b> .....	<b>7</b>
<i>matching colours</i>	

<b>SCRIVANIE DIREZIONALI (PIANI SP. 18mm) e SCHIENE</b> .....	<b>10</b>
<i>executive desks (tops thick. 18mm) and modesty panels</i>	

<b>SCRIVANIE DIREZIONALI (PIANI IN VETRO FLOAT SP. MM 10 RETROLACCATO)</b> .....	<b>12</b>
<i>executive desks (square edged rear-lacquered float glazed tops thick. 10mm)</i>	

<b>ALLUNGHI (PIANI IN VETRO FLOAT SP. MM 10 RETROLACCATO)</b> .....	<b>13</b>
<i>extensions (square edged rear-lacquered float glazed tops thick. 10mm)</i>	

<b>SCHIENE PER SCRIVANIE DIREZIONALI CON PIANO IN VETRO</b> .....	<b>14</b>
<i>modesty panels for executive desks with glazed top</i>	

## Desking-Bench

<b>SCRIVANIE SINGOLE CON GAMBE METALLICHE A PONTE (PIANI SP. 18mm)</b> .....	<b>21</b>
<i>single desks with bridge metal legs (tops thick. 18mm)</i>	

<b>PANNELLI FRONTALI E ACCESSORI</b> .....	<b>22</b>
<i>front panels and accessories</i>	

<b>SCRIVANIE IN LINEA PROF.80 CON GAMBE A PONTE (PIANI SP. 18mm)</b> .....	<b>23</b>
<i>linear desks deep 80 cms with bridge legs (tops thick. 18mm)</i>	

<b>BENCH PROF.60+60 (PIANI SP. 18mm)</b> .....	<b>24</b>
<i>bench deep 60+60 cms (tops thick. 18mm)</i>	

<b>BENCH PROF.80+80 (PIANI SP. 18mm)</b> .....	<b>24</b>
<i>bench deep 80+80 cms (tops thick. 18mm)</i>	

<b>BENCH PROF.60+60 CON PIANI SCORREVOLI (PIANI SP. 18mm)</b> .....	<b>25</b>
<i>bench deep 60+60 cms with sliding worktops (tops thick. 18mm)</i>	

<b>BENCH PROF.80+80 CON PIANI SCORREVOLI (PIANI SP. 18mm)</b> .....	<b>25</b>
<i>bench deep 80+80 cms with sliding worktops (tops thick. 18mm)</i>	

<b>SCRIVANIE CON GAMBA A PONTE (PIANI SP. 18mm)</b> .....	<b>26</b>
<i>desks with bridge leg (tops thick. 18mm)</i>	

<b>COMPLEMENTI PER BENCH</b> .....	<b>28</b>
<i>complements for bench</i>	

<b>BARRE ATTREZZABILI FRONTALI E COMPLEMENTI PER BENCH</b> .....	<b>30</b>
<i>front toolbars and complements for bench</i>	

<b>BARRE ATTREZZABILI LATERALI A FILO PIANO</b> .....	<b>31</b>
<i>lateral desk height toolbars</i>	

<b>PANNELLI FRONTALI CON BARRA-ATTREZZABILE PER BENCH (h.38,2 DAL PIANO SCRIVANIA)</b> .....	<b>32</b>
<i>front panels with toolbar for bench (h.38,2 cms from worktop)</i>	

<b>PANNELLI FRONTALI CON BARRA-ATTREZZABILE PER BENCH (h.46,7 DAL PIANO SCRIVANIA)</b> .....	<b>32</b>
<i>front panels with toolbar for bench (h.46,7 cms from worktop)</i>	

<b>ACCESSORI PER PANNELLI FRONTALI CON BARRA ATTREZZABILE</b> .....	<b>33</b>
<i>accessories for front panels with toolbar</i>	

<b>PIANI SCRIVANIE PER GAMBE A PONTE</b> .....	<b>34</b>
<i>desktops for bridge legs</i>	

<b>PIANI TERMINALI PER BENCH</b> .....	<b>34</b>
<i>terminal tops for bench</i>	

<b>GAMBE METALLICHE A PONTE CON ALTEZZA REGOLABILE</b> .....	<b>35</b>
<i>bridge metal legs with adjustable heigh</i>	

<b>GAMBE METALLICHE A PONTE E KIT WIRE-MANAGER</b> .....	<b>35</b>
<i>bridge metal legs and wire-manager kit</i>	

<b>GAMBE METALLICHE A PONTE TERMINALI DA APPOGGIO</b> .....	<b>36</b>
<i>short terminal bridge metal legs</i>	

<b>TRAVI DI SUPPORTO</b> .....	<b>36</b>
<i>support beams</i>	

<b>VASCETTE CENTRALI PASSA-CAVI PER BENCH E SCRIVANIE SINGOLE</b> .....	<b>37</b>
<i>central cable trays for bench and single desks</i>	

<b>SCHEMA DI UTILIZZO TRAVI E VASCETTE PORTA-CAVI</b> .....	<b>38</b>
<i>scheme of using support beams and cable-tray</i>	

<b>STAFFE</b> .....	<b>39</b>
<i>stirrups</i>	



## System

<b>MODULI PARETINE H.111</b> .....	<b>43</b>
<i>partition panels h.111 cms</i>	
<b>MODULI PARETINE H.150</b> .....	<b>44</b>
<i>partition panels h.150 cms</i>	
<b>MODULI PARETINE H.150</b> .....	<b>45</b>
<i>partition panels h.150 cms</i>	
<b>PIANI SCRIVANIE BORDATI SP. 25mm (MELAMINICO)</b> .....	<b>45</b>
<i>square edged desktops thick 25mm (melamine)</i>	
<b>ALLUNGHI SP. 25mm (MELAMINICO)</b> .....	<b>46</b>
<i>square edged extensions and tops thick 25mm (melamine)</i>	
<b>MONTANTI, GAMBE A CORNICE, TRAVI E STAFFE PER PARETINE</b> .....	<b>47</b>
<i>uprights, frame legs, beams and stirrups for partition panels</i>	
<b>KIT PIASTRINI PER SUPPORTO PIANI SU PARETINE</b> .....	<b>48</b>
<i>kit of support plates for desktops with panels system</i>	
<b>CANALINE PASSACAVI PER PARETINE</b> .....	<b>49</b>
<i>cable trays for partition panels</i>	
<b>MENSOLE PER PARETINE H.150</b> .....	<b>49</b>
<i>shelves for partition panels h.150 cms</i>	
<b>PENSILI PORTA-DOX PER PARETINE H.150</b> .....	<b>50</b>
<i>suspended storage cabinets for partitions panels h.150 cms</i>	
<b>ACCESSORI</b> .....	<b>51</b>
<i>accessories</i>	
<b>MOBILI DI SERVIZIO E PORTA-CPU</b> .....	<b>52</b>
<i>service units and CPU-holder</i>	
<b>MOBILI DI SERVIZIO E PORTA-CPU</b> .....	<b>53</b>
<i>service units and CPU-holder</i>	
<b>CLASSIFICATORE FREE-STANDING</b> .....	<b>54</b>
<i>free-standing file pedestal</i>	
<b>CONTENITORE BASSO L.80</b> .....	<b>55</b>
<i>low cabinet w 80 cms</i>	
<b>TOP PER CONTENITORE BASSO L.80</b> .....	<b>56</b>
<i>top for low cabinet w 80 cms</i>	
<b>CASSETTIERE SU RUOTE</b> .....	<b>57</b>
<i>mobile pedestals</i>	
<b>ACCESSORI PER CASSETTIERE SU RUOTE</b> .....	<b>58</b>
<i>accessories for pedestals on wheels</i>	
<b>CASSETTIERE-BASI O LATERALI PER PIANI PROF. CM 60-80</b> .....	<b>59</b>
<i>base or lateral pedestals for desktops deep 60-80 cms</i>	
<b>TOP PER CASSETTIERE-BASI</b> .....	<b>60</b>
<i>top for base-pedestals</i>	
<b>STORAGE STANDARD PER PIANI PROF. CM 80</b> .....	<b>61</b>
<i>standard storage for desktops deep 80 cms</i>	
<b>TOP PER STORAGE</b> .....	<b>62</b>
<i>top for storage</i>	
<b>ACCESSORI</b> .....	<b>63</b>
<i>accessories</i>	
<b>KIT ELETRIFICAZIONE tipo K1 (BACHMANN)</b> .....	<b>64</b>
<i>electrification kit type K1 (by Bachmann)</i>	
<b>KIT ELETRIFICAZIONE tipo K2 (BACHMANN)</b> .....	<b>64</b>
<i>electrification kit type K2 (by Bachmann)</i>	
<b>TAVOLI RIUNIONE (PIANI SP. 18mm)</b> .....	<b>67</b>
<i>meeting tables (tops thick. 18mm)</i>	
<b>TAVOLI TEAM (PIANI SP. 18mm)</b> .....	<b>71</b>
<i>team tables (tops thick. 18mm)</i>	
<b>DESCRIZIONE TECNICA</b> .....	<b>72</b>
<b>TECHNICAL DESCRIPTION</b> .....	<b>74</b>
<b>INDICE DEI CODICI</b> .....	<b>76</b>
<i>codes index</i>	

Elementi comuni  
shared elements

## Meeting

## CERTIFICAZIONI DISPONIBILI / available certifications

### MATERIALI E FINITURE / materials and finishes

	NORMA DI RIFERIMENTO standard norms	DESCRIZIONE NORMA	norm descriptions
	Conformità DM 03/09/2001	Reazione al fuoco. Dichiarazione di conformità al DM 26/06/1984 modificato da DM 03/09/2001.	Reaction to fire. Declaration of conformity to the MD 26/06/1984 modified by MD 03/09/2001.
	UNI EN 12720:1997	Resistenza ai liquidi freddi.	Cold liquids resistance.
	UNI EN 12722:1997	Resistenza al calore secco.	Dry heat resistance.
	UNI EN 13722:2004	Riflessione speculare della superficie	Measurement of specular gloss of the surface.
	UNI EN ISO 12460 - 3:2015	Rilascio di formaldeide. Gas analisi, prova singola.	Formaldehyde release.
	UNI 10460:1995	Determinazione della resistenza dei bordi all'acqua.	Water resistance of the edges.
	UNI 8941-2:1987	Colorimetria. Determinazione strumentale del colore.	Colourimetry. Test for the determination of the colour.
	UNI 9115:1987	Comportamento delle superfici all'usura per abrasione. Abrasione Taber.	Taber abrasion. Test for abrasion resistance of the surfaces.
	UNI 9242:1987 + UNI 9242:1987/A1/98	Determinazione della resistenza dei bordi al calore.	Determination of heat resistance of the edges.
	UNI 9300:1988 + FA 276:1989	Determinazione della tendenza della superficie a ritenere lo sporco.	Test for surfaces tendency to retain dirt.
	UNI EN 15187:2007	Valutazione degli effetti dell'esposizione alla luce.	Evaluation of the effects of the exposure to the light.
	UNI 9428:1989	Prove sulle finiture delle superfici. Determinazione della resistenza alla graffiatura.	Test for scratch resistance of the surfaces.
	UNI 9429:1989	Determinazione della resistenza delle superfici agli sbalzi di temperatura.	Test for thermal endurance of the surfaces.
	UNI EN 12721:2009	Valutazione della resistenza delle superfici al calore umido.	Test for the determination of damp heat resistance.
ELEMENTI METALLICI / metallic elements	ASTM D 3363:2005	Prova di durezza molla e/o matita.	Hardness test to pencil.
	EN ISO 1520:1995	Imbutitura statica.	Static drawing test.
	UNI 8901:1986	Resistenza all'urto.	Impact resistance.
	UNI 9115:1987	Comportamento delle superfici all'usura per abrasione. Abrasione Taber.	Taber abrasion. Test for abrasion resistance of the surfaces.
	UNI 9427:1989	Determinazione della resistenza delle superfici alla luce.	Test for light resistance of the surfaces.
	UNI 9428:1989	Prove sulle finiture delle superfici. Determinazione della resistenza alla graffiatura.	Test for scratch resistance of the surfaces.
	UNI 9429:1989	Determinazione della resistenza delle superfici agli sbalzi di temperatura.	Test for thermal endurance .
	UNI EN ISO 2409:1996	Adesione mediante quadrettatura.	Adhesion with checkering.
	UNI EN ISO 2808:2007	Pitture e vernici. Determinazione dello spessore del film.	Paints and varnishes. Determination of the film thickness.
	UNI EN ISO 9227:2006	Prove in nebbia salina.	Test for salt fog resistance.

ULTIMA REVISIONE: GENNAIO 2018  
latest revision: JANUARY 2018

Per eventuali aggiornamenti più recenti  
le **CERTIFICAZIONI** e i **LISTINI** sono disponibili su Internet:  
For latest datings  
the **CERTIFICATIONS** and **PRICE LIST** are available on Internet:

- 1-  [www.las.it](http://www.las.it)
- 2- AREA RISERVATA RIVENDITORE  
Dealer's private area
- 3- SCARICA DOCUMENTI IN FORMATO .PDF  
Downloads .PDF files



**N.B.: ALTRE TIPOLOGIE DI MOBILI CONTENITORI  
E LIBRERIE A SPALLA UNICA  
SONO INSERITI NEL CAPITOLO "CONTENITORI UNIVERSALI EVO"**  
PLEASE NOTE: you can find other cabinet models  
and bookcases with shared side panel in the section "**UNIVERSAL CABINETS EVO**"

## - Schema Altezze - scheme of heights

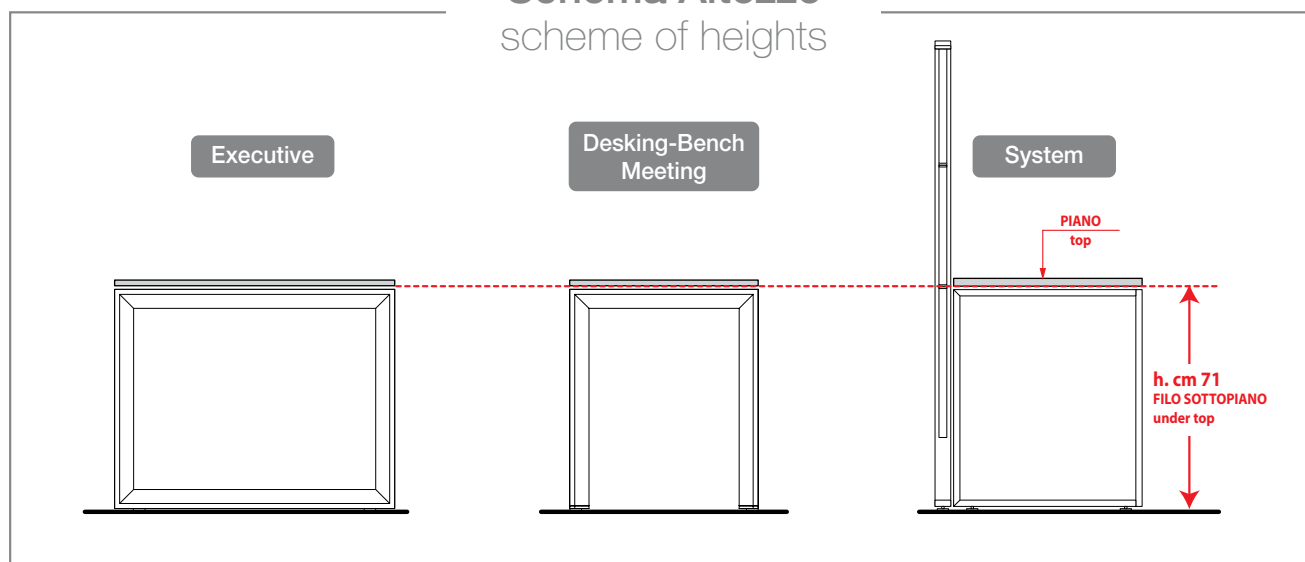

## CARTELLA COLORI

colours samples card

### PIANI DI LAVORO, PARETINE

work tops, partition panels



COD. 03  
ROVERE | OAK



COD. 04  
ROVERE GREY | GREY OAK



COD. 06  
NOCE PAVIA | PAVIA WALNUT



COD. 44  
STONE GREY | STONE GREY



COD. 45  
WENGÉ | WENGÉ



COD. 58  
ACERO TAKI | TAKI MAPLE

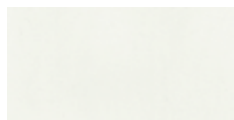

COD. 69  
BIANCO BR. | BR. WHITE

### IN ABBINAMENTO

matching colours



COD. 01  
ARGENTO GOLF | GOLF SILVER



COD. 44  
STONE GREY | STONE GREY



COD. 55  
ANTRACITE | ANTHRACITE

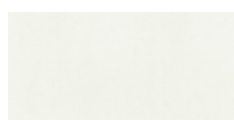

COD. 69  
BIANCO BR. | BR. WHITE

### FRONTALI E SCHIENA DI CASSETTIERE, MOBILI SOTTOPIANO E MOBILI DI SERVIZIO

fronts and back panel of pedestals, undertop cabinets and service units



COD. 01  
ARGENTO GOLF | GOLF SILVER



COD. 03  
ROVERE | OAK



COD. 04  
ROVERE GREY | GREY OAK



COD. 06  
NOCE PAVIA | PAVIA WALNUT



COD. 11  
GIALLO FRESIA | FREESIA YELLOW



COD. 32  
AZZURRO SKY | SKY BLUE



COD. 33  
AMARANTO | AMARANTH



COD. 44  
STONE GREY | STONE GREY



COD. 45  
WENGÉ | WENGÉ



COD. 55  
ANTRACITE | ANTHRACITE



COD. 58  
ACERO TAKI | TAKI MAPLE

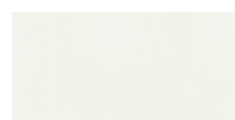

COD. 69  
BIANCO BR. | BR. WHITE



COD. 96  
VERDE BOSCO | WOOD GREEN

### PIANI IN VETRO

glass tops



COD. 10  
NERO | BLACK



COD. 72  
TORTORA | GREY BEIGE



COD. 74  
ROSSO RUBINO | RUBY RED



COD. 79  
BIANCO | WHITE

## Cat. F



**POLIESTERE STRETCH IGNIFUGO**  
100% poliestere FR riciclato  
Martindale 50.000

**FIRE-RETARDANT STRETCH POLYESTER**  
100% polyester FR recycled  
Martindale 50.000

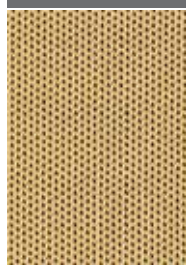

321  
GIALLO FRESIA | FREESIA YELLOW



320  
AZZURRO SKY | SKY BLUE



322  
AMARANTO | AMARANTH



323  
VERDE BOSCO | WOOD GREEN



327  
GRIGIO | GREY



328  
TORTORA | GREY BEIGE



330  
MATTONE | BRICK RED



331  
ARANCIO | ORANGE



332  
ROSSO | RED



333  
VERDE ACIDO | ACID GREEN



334  
BLU | BLUE

**ABBINAMENTI COLORI**  
matching colours

**5<sup>TH</sup> ELEMENT**

		COLORI LEGNI wooden colours											TESTI				
		ROVERE oak	ROVERE GREY grey oak	NOCE PAVIA pavia walnut	WENGÈ wengè	ACERO TAKI taki maple	BIANCO BR. br. white	ARGENTO GOLF golf silver	ANTRACITE anthracite	STONE GREY stone grey	GIALLO FRESIA freesia yellow	AZZURRO SKY sky blue	AMARAN- TO amaranth	VERDE BOSCO acid green	AZZURRO SKY sky blue	GIALLO FRESIA freesia yellow	AMARANTO amarant
COMPONENTI components		Cod. 03	Cod. 04	Cod. 06	Cod. 45	Cod. 58	Cod. 69	Cod. 01	Cod. 55	Cod. 44	Cod. 11	Cod. 32	Cod. 33	Cod. 96	Cod. 320	Cod. 321	Cod. 322
SCRIVANIE E TAVOLI RIUNIONE desks and meeting table	PIANO E TOP ACCESS desktop and top access	◊	◊	◊	◊	◊	◊			◊							
	TRAVI beam																
	GAMBE legs																
SCHIENE PER SCRIVANIE EXECUTIVE executive modesty panel	PANNELLO panel	◊	◊	◊	◊	◊	◊			◊							
	STAFFE stirrups																
SCHIENE PER SCRIVANIE OPERATIVE operative modesty panel	PANNELLO panel						◊	◊	◊	◊							
	STAFFE stirrups																
VASCETTE PASSACAVI cable trays																	
CASSETTIERE SU RUOTE mobile pedestals	TOP FRONTALI E SCHIENA top, fronts and back panel	◊	◊	◊	◊	◊	◊	◊	◊	◊	◊	◊	◊	◊			
	STRUTTURA structure						◊	◊	◊	◊	◊	◊	◊	◊			
CASSETTIERE-BASI MOBILE SOTTOPIANO MOBILI DI SERVIZIO base-pedestals undertop cabinet service units mobile pedestals	TOP, FRONTALI E SCHIENA top, fronts and back panel	◊	◊	◊	◊	◊	◊	◊	◊	◊	◊	◊	◊	◊			
	STRUTTURA structure						◊	◊	◊	◊							
PANNELLI FRONTALI E LATERALI front panels and side panel	PANNELLO panel	◊	◊	◊	◊	◊	◊	◊	◊	◊					◊	◊	◊
	SUPPORTI supports																
PARETINE partition panels	PANNELLO INFERIORE lower panel							◊									
	PANNELLI SUPERIORI upper panels	◊	◊	◊	◊	◊	◊			◊					◊		
	TELAIO frame																
GAMBE A CORNICE PER PARETINE frame legs for partition panels																	
TRAVI E STAFFE beams and stirrups																	
MENSOLE PER PARETINE shelves for partition panel	MENSOLE shelf							◊									
	BARRA DI SUPPORTO support bar																
PENSILI PORTA- DOX suspended storage cabinet	ANTA door	◊	◊	◊	◊	◊	◊			◊							
	STRUTTURA structure							◊									

SUTO POLIESTERE STRETCH IGNIFUGO fire-retardant stretch polyester fabric								COLORI VETRI glass colours				COLORI METALLI metal colours							
VERDE BOSCO wood green	GRIGIO grey	TORTORA grey beige	MATTONE brick red	ARANCIO orange	ROSSO red	VERDE ACIDO acid green	BLU blue	NERO black	TORTORA grey beige	ROSSO RUBINO ruby red	BIANCO white	META-CRILATO BIANCO white methacrylate	ARGENTO silver	BIANCO white	ANTRACITE anthracite	STONE GREY stone grey	CROMATO chromed	ALLUMINIO aluminium	
Cod. 323	Cod. 327	Cod. 328	Cod. 330	Cod. 331	Cod. 332	Cod. 333	Cod. 334	Cod. 10	Cod. 72	Cod. 74	Cod. 79		AR 02	BI 02	AN 02	SG 01	CR 01	-	
								◇	◇	◇	◇								
													◇	◇	◇	◇			
													◇	◇	◇	◇	◇		
													◇						
													◇	◇	◇	◇			
◇	◇	◇	◇	◇	◇	◇	◇					◇							
													◇						
◇						◇						◇							
																			◇
													◇						
													◇						
																			◇

5<sup>TH</sup> ELEMENT

# Executive



## • GAMBA METALLICA A PONTE

MATERIALE: Tubolare metallico a sezione trapezoidale

FINITURA: Verniciatura a polveri epossidiche nei colori: Argento, Bianco, Antracite, Stone grey

CARATTERISTICA: Predisposta per il fissaggio delle travi portanti. Dotata di piedini livellatori.

## • BRIDGE METAL LEG

MATERIAL: Metallic tubular with trapezoidal section

FINISH: Painted with epoxy resin powder in colours: Silver, White, Anthracite, Stone grey

FEATURE: The leg is predisposed for to fix the supporting beams. Adjustable feet included.

## • GAMBA METALLICA A "LOOP"

MATERIALE: Tubolare metallico a sezione trapezoidale

FINITURA: Verniciatura a polveri epossidiche nei colori: Argento, Bianco, Antracite, Stone grey oppure nella versione CROMATA lucida.

CARATTERISTICA: Predisposta per il fissaggio delle travi portanti. Dotata di piedini livellatori.

## • "LOOP" METAL LEG

MATERIAL: Metallic tubular with trapezoidal section

FINISH: Painted with epoxy resin powder in colours: Silver, White, Anthracite, Stone grey or shine CHROME version.

FEATURE: The leg is predisposed for to fix the supporting beams. Adjustable feet included.



## • MODESTY PANEL

MATERIALE: Pannello di particelle di legno sp. 18mm

FINITURA: Nobilitato in melaminico

COLORI: Acero Taki, Bianco Br., Wengè, Noce Pavia, Stone grey, Rovere, Rovere grey.

CARATTERISTICA: Dotato di staffe metalliche idonee al fissaggio sottopiano

## • MODESTY PANEL

MATERIAL: Particleboard panel thick. 18mm

FINISH: Melamine-faced

COLOURS: Taki Maple, Br. White, Wengè, Pavia walnut, Stone grey, Oak, Grey oak.

FEATURE: It is furnished with metallic stirrups for undertop fixing

## • PIANI DI LAVORO

MATERIALE:

Pannello di particelle di legno sp. 18mm nobilitato in melaminico oppure vetro temperato sp. 10mm

COLORI MELAMINICO: Acero Taki, Bianco Br., Wengè, Noce Pavia, Stone grey, Rovere, Rovere grey.

COLORI VETRO: Nero, Rosso Rubino, Tortora, Bianco.

## • WORK TOPS

MATERIAL: Particleboard panel 18mm thick. melamine-faced or tempered glass 10 mm thick.

MELAMINE COLOURS: Taki Maple, Br. White, Wengè, Pavia walnut, Stone grey, Oak, Grey oak.

GLASS COLOURS: Black, Ruby Red, Grey beige, White.



# 5<sup>TH</sup> ELEMENT



## • TRAVI DI SOSTEGNO

MATERIALE: Tubolare metallico a sezione rettangolare

FINITURA: Verniciatura a polveri epossidiche nei colori Argento, Bianco, Antracite, Stone grey.

CARATTERISTICA: Predisposte per il fissaggio delle gambe ponte e dei piani.

## • SUPPORTING BEAMS

MATERIAL: Metallic tubular with rectangular section

FINISH: Painted with epoxy resin powder in colours Silver, White, Anthracite, Stone grey.

FEATURE: The beams are predisposed for to fix the bridge legs and the tops.

## • MOBILE-BASE

MATERIALE: Pannello di particelle di legno sp. 18mm

FINITURA: Nobilitato in melaminico

COLORI: Acero Taki, Bianco Br., Wengè, Noce Pavia, Stone grey, Rovere, Rovere grey.

CARATTERISTICA: Consente l'alloggiamento del PC-Tower e il cablaggio tramite aperture sulla base e sul cappello. Dotato di piedini livellatori.

## • BASE-CABINET



MATERIAL: Particleboard panel 18 mm thick.

FINISH: Melamine-faced

COLOURS: Taki Maple, Br. White, Wengè, Pavia walnut, Stone grey, Oak, Grey oak.

FEATURE: It allows the PC-Tower lodging and the wire-manager through a bottom and upper opening. Adjustable feet included.

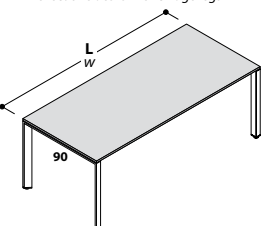

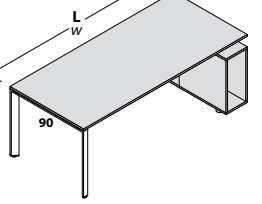
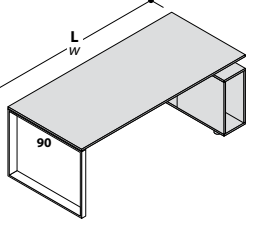
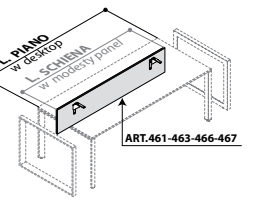
SCRIVANIE DIREZIONALI (PIANI SP. 18mm) e SCHIENE executive desks (tops thick. 18mm) and modesty panels										
DESCRIZIONE description	L w	CODICE code	KG	M <sup>3</sup>	COLLI	PREZZO price	PREZZO price	(*) CODICE FINITURA (*) finish code		
SCRIVANIE DIREZIONALI CON GAMBE A PONTE executive desks with bridge legs  L. x p.90 x H.72,8						<b>GAMBE VERNICIATE</b>  painted legs	<b>GAMBE CROMATE</b>  chromed legs			
	L.160	153 <b>890</b> (*)	40	0,208	4	€ 388,00	€ 712,00			
	L.180	153 <b>903</b> (*)	42	0,209	4	€ 404,00	€ 728,00			
	L.200	153 <b>904</b> (*)	53	0,220	4	€ 424,00	€ 748,00			
	L.220	153 <b>905</b> (*)	57	0,230	4	€ 442,00	€ 766,00			
SCRIVANIE DIREZIONALI CON GAMBA A PONTE E MOBILE-BASE DX O SX executive desks with bridge leg and undertop cabinet (right or left)  L. x p.90 x H.72,8	L.180	153 <b>908</b> (*)	59	0,220	5	€ 426,00	€ 588,00			
	L.200	153 <b>906</b> (*)	71	0,228	5	€ 442,00	€ 604,00			
	<b>★ GAMBE VERNICIATE / painted legs</b>									
	(*)	PIANO e MOBILE	STRUTTURA	top and cabinet		structure				
	003	ROVERE	ARGENTO	oak		silver				
	004	ROVERE GREY	ARGENTO	grey oak		silver				
	020	ACERO TAKI	ARGENTO	taksi maple		silver				
	040	BIANCO BR.	ARGENTO	br. white		silver				
	044	STONE GREY	ARGENTO	stone grey		silver				
	066	NOCE PAVIA	ARGENTO	pavia walnut		silver				
	090	WENGÉ	ARGENTO	wengé		silver				
	400	BIANCO BR.	BIANCO	br. white		white				
	403	ROVERE	BIANCO	oak		white				
404	ROVERE GREY	BIANCO	grey oak		white					
420	ACERO TAKI	BIANCO	taksi maple		white					
444	STONE GREY	BIANCO	stone grey		white					
466	NOCE PAVIA	BIANCO	pavia walnut		white					
490	WENGÉ	BIANCO	wengé		white					
503	ROVERE	ANTRACITE	oak		anthracite					
504	ROVERE GREY	ANTRACITE	grey oak		anthracite					
521	ACERO TAKI	ANTRACITE	taksi maple		anthracite					
541	BIANCO BR.	ANTRACITE	br. white		anthracite					
544	STONE GREY	ANTRACITE	stone grey		anthracite					
566	NOCE PAVIA	ANTRACITE	pavia walnut		anthracite					
591	WENGÉ	ANTRACITE	wengé		anthracite					
803	ROVERE	STONE GREY	oak		stone grey					
804	ROVERE GREY	STONE GREY	grey oak		stone grey					
820	ACERO TAKI	STONE GREY	taksi maple		stone grey					
840	BIANCO BR.	STONE GREY	br. white		stone grey					
844	STONE GREY	STONE GREY	stone grey		stone grey					
866	NOCE PAVIA	STONE GREY	pavia walnut		stone grey					
890	WENGÉ	STONE GREY	wengé		stone grey					
<b>○ GAMBE CROMATE / chromed legs</b>										
903	ROVERE	CROMATO	oak		chromed					
904	ROVERE GREY	CROMATO	grey oak		chromed					
920	ACERO TAKI	CROMATO	taksi maple		chromed					
940	BIANCO BR.	CROMATO	br. white		chromed					
944	STONE GREY	CROMATO	stone grey		chromed					
966	NOCE PAVIA	CROMATO	pavia walnut		chromed					
990	WENGÉ	CROMATO	wengé		chromed					
SCRIVANIE DIREZIONALI CON GAMBA A "LOOP" E MOBILE-BASE DX O SX executive desks with "loop" leg and undertop cabinet (right or left)  L. x p.90 x H.72,8	L.180	153 <b>910</b> (*)	58	0,220	5	€ 472,00	€ 654,00			
	L.200	153 <b>913</b> (*)	70	0,228	5	€ 488,00	€ 670,00			
	<b>○ GAMBE CROMATE / chromed legs</b>									
	903	ROVERE	CROMATO	oak		chromed				
	904	ROVERE GREY	CROMATO	grey oak		chromed				
920	ACERO TAKI	CROMATO	taksi maple		chromed					
940	BIANCO BR.	CROMATO	br. white		chromed					
944	STONE GREY	CROMATO	stone grey		chromed					
966	NOCE PAVIA	CROMATO	pavia walnut		chromed					
990	WENGÉ	CROMATO	wengé		chromed					
SCHIENE PER SCRIVANIE DIREZIONALI CON PIANO IN LEGNO modesty panels for executive desks with wooden top  L. x p.1,8 x H.30	L.147	L.160	153 <b>461</b> (*)	9	0,026	2	€ 40,00			
	L.167	L.180	153 <b>463</b> (*)	10	0,029	2	€ 43,00			
	L.187	L.200	153 <b>466</b> (*)	11	0,029	2	€ 54,00			
	L.207	L.220	153 <b>467</b> (*)	13	0,029	2	€ 59,00			
	<b>UTILIZZARE SU PIANI use for desktops</b>									
	L.145,9	L.180	153 <b>464</b> (*)	9	0,029	2	€ 40,00			
	L.165,9	L.200	153 <b>468</b> (*)	11	0,029	2	€ 51,00			
	<b>UTILIZZARE SU PIANI use for desktops</b>									
	(*)	SCHIENA	modesty panel							
	166	NOCE PAVIA	pavia walnut							
200	ACERO TAKI	taksi maple								
400	BIANCO BR.	br. white								
704	ROVERE GREY	grey oak								
733	ROVERE	oak								
844	STONE GREY	stone grey								
900	WENGÉ	wengé								

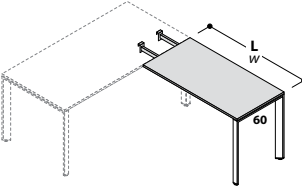
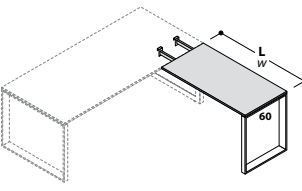
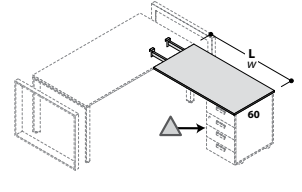

**ALLUNGHI CON GAMBE METALLICHE (PIANI SP. 18mm)***extensions with metal legs (tops thick. 18mm)*

DESCRIZIONE <i>description</i>	L <i>w</i>	CODICE <i>code</i>	KG	M <sup>3</sup>	COLLI	PREZZO <i>price</i>	PREZZO <i>price</i>	(*) CODICE FINITURA <i>(*) finish code</i>																						
								PIANO	STRUTTURA	<i>top</i>	<i>structure</i>																			
ALLUNGHI DX O SX CON GAMBA A PONTE <i>right or left extensions with bridge leg</i>    L. x p.60 x H.72,8	<table border="1"> <tr> <td>L.80</td> <td>153 013 (*)</td> <td>17</td> <td>0,084</td> <td>4</td> <td>€ 236,00</td> <td>€ 371,00</td> </tr> <tr> <td>L.100</td> <td>153 014 (*)</td> <td>20</td> <td>0,094</td> <td>4</td> <td>€ 248,00</td> <td>€ 383,00</td> </tr> <tr> <td>L.120</td> <td>153 010 (*)</td> <td>24</td> <td>0,102</td> <td>4</td> <td>€ 259,00</td> <td>€ 394,00</td> </tr> </table>	L.80	153 013 (*)	17	0,084	4	€ 236,00	€ 371,00	L.100	153 014 (*)	20	0,094	4	€ 248,00	€ 383,00	L.120	153 010 (*)	24	0,102	4	€ 259,00	€ 394,00	GAMBE VERNICIATE ★ <i>painted legs</i>				GAMBE CROMATE ○ <i>chromed legs</i>			
		L.80	153 013 (*)	17	0,084	4	€ 236,00	€ 371,00																						
		L.100	153 014 (*)	20	0,094	4	€ 248,00	€ 383,00																						
		L.120	153 010 (*)	24	0,102	4	€ 259,00	€ 394,00																						
		★ <b>GAMBE VERNICIATE / painted legs</b>																												
		(*)	PIANO	STRUTTURA	<i>top</i>	<i>structure</i>																								
		003	ROVERE	ARGENTO	oak	silver																								
		004	ROVERE GREY	ARGENTO	grey oak	silver																								
		020	ACERO TAKI	ARGENTO	taki maple	silver																								
		040	BIANCO BR.	ARGENTO	br. white	silver																								
044	STONE GREY	ARGENTO	stone grey	silver																										
066	NOCE PAVIA	ARGENTO	pavia walnut	silver																										
090	WENGÉ	ARGENTO	wengé	silver																										
400	BIANCO BR.	BIANCO	br. white	white																										
403	ROVERE	BIANCO	oak	white																										
404	ROVERE GREY	BIANCO	grey oak	white																										
420	ACERO TAKI	BIANCO	taki maple	white																										
444	STONE GREY	BIANCO	stone grey	white																										
466	NOCE PAVIA	BIANCO	pavia walnut	white																										
490	WENGÉ	BIANCO	wengé	white																										
503	ROVERE	ANTRACITE	oak	anthracite																										
504	ROVERE GREY	ANTRACITE	grey oak	anthracite																										
521	ACERO TAKI	ANTRACITE	taki maple	anthracite																										
541	BIANCO BR.	ANTRACITE	br. white	anthracite																										
544	STONE GREY	ANTRACITE	stone grey	anthracite																										
566	NOCE PAVIA	ANTRACITE	pavia walnut	anthracite																										
591	WENGÉ	ANTRACITE	wengé	anthracite																										
803	ROVERE	STONE GREY	oak	stone grey																										
804	ROVERE GREY	STONE GREY	grey oak	stone grey																										
820	ACERO TAKI	STONE GREY	taki maple	stone grey																										
840	BIANCO BR.	STONE GREY	br. white	stone grey																										
844	STONE GREY	STONE GREY	stone grey	stone grey																										
866	NOCE PAVIA	STONE GREY	pavia walnut	stone grey																										
890	WENGÉ	STONE GREY	wengé	stone grey																										
				○ <b>GAMBE CROMATE / chromed legs</b>																										
903	ROVERE	CROMATO	oak	chromed																										
904	ROVERE GREY	CROMATO	grey oak	chromed																										
920	ACERO TAKI	CROMATO	taki maple	chromed																										
940	BIANCO BR.	CROMATO	br. white	chromed																										
944	STONE GREY	CROMATO	stone grey	chromed																										
966	NOCE PAVIA	CROMATO	pavia walnut	chromed																										
990	WENGÉ	CROMATO	wengé	chromed																										
ALLUNGHI DX O SX CON GAMBA A "LOOP" <i>right or left extensions with "loop" leg</i>    L. x p.60 x H.72,8	<table border="1"> <tr> <td>L.80</td> <td>153 095 (*)</td> <td>18</td> <td>0,084</td> <td>4</td> <td>€ 286,00</td> <td>€ 461,00</td> </tr> <tr> <td>L.100</td> <td>153 096 (*)</td> <td>21</td> <td>0,094</td> <td>4</td> <td>€ 298,00</td> <td>€ 473,00</td> </tr> <tr> <td>L.120</td> <td>153 097 (*)</td> <td>25</td> <td>0,102</td> <td>4</td> <td>€ 309,00</td> <td>€ 484,00</td> </tr> </table>	L.80	153 095 (*)	18	0,084	4	€ 286,00	€ 461,00	L.100	153 096 (*)	21	0,094	4	€ 298,00	€ 473,00	L.120	153 097 (*)	25	0,102	4	€ 309,00	€ 484,00								
		L.80	153 095 (*)	18	0,084	4	€ 286,00	€ 461,00																						
		L.100	153 096 (*)	21	0,094	4	€ 298,00	€ 473,00																						
		L.120	153 097 (*)	25	0,102	4	€ 309,00	€ 484,00																						
						○ <b>GAMBE CROMATE / chromed legs</b>																								
		903	ROVERE	CROMATO	oak	chromed																								
		904	ROVERE GREY	CROMATO	grey oak	chromed																								
		920	ACERO TAKI	CROMATO	taki maple	chromed																								
		940	BIANCO BR.	CROMATO	br. white	chromed																								
		944	STONE GREY	CROMATO	stone grey	chromed																								
966	NOCE PAVIA	CROMATO	pavia walnut	chromed																										
990	WENGÉ	CROMATO	wengé	chromed																										
ALLUNGHI DX O SX PER CASSETTIERA-BASE <i>right or left extensions for base-pedestal</i>    L. x p.60 x H.1,8	<table border="1"> <tr> <td>L.80</td> <td>153 018 (*)</td> <td>9,5</td> <td>0,045</td> <td>3</td> <td>€ 124,00</td> <td></td> </tr> <tr> <td>L.100</td> <td>153 019 (*)</td> <td>12</td> <td>0,052</td> <td>3</td> <td>€ 133,00</td> <td></td> </tr> <tr> <td>L.120</td> <td>153 015 (*)</td> <td>15</td> <td>0,062</td> <td>3</td> <td>€ 136,00</td> <td></td> </tr> </table>	L.80	153 018 (*)	9,5	0,045	3	€ 124,00		L.100	153 019 (*)	12	0,052	3	€ 133,00		L.120	153 015 (*)	15	0,062	3	€ 136,00									
		L.80	153 018 (*)	9,5	0,045	3	€ 124,00																							
		L.100	153 019 (*)	12	0,052	3	€ 133,00																							
		L.120	153 015 (*)	15	0,062	3	€ 136,00																							
		▲ <b>COMPLETARE SEMPRE CON CASSETTIERA-BASE ART.764-775 PAG.59</b> <i>to be always complete with base-pedestal art.764-775 page 59</i>																												
		(*)	PIANO	TRAVI	<i>top</i>	<i>beams</i>																								
		003	ROVERE	ARGENTO	oak	silver																								
		004	ROVERE GREY	ARGENTO	grey oak	silver																								
		020	ACERO TAKI	ARGENTO	taki maple	silver																								
		040	BIANCO BR.	ARGENTO	br. white	silver																								
044	STONE GREY	ARGENTO	stone grey	silver																										
066	NOCE PAVIA	ARGENTO	pavia walnut	silver																										
090	WENGÉ	ARGENTO	wengé	silver																										
400	BIANCO BR.	BIANCO	br. white	white																										
403	ROVERE	BIANCO	oak	white																										
404	ROVERE GREY	BIANCO	grey oak	white																										
420	ACERO TAKI	BIANCO	taki maple	white																										
444	STONE GREY	BIANCO	stone grey	white																										
466	NOCE PAVIA	BIANCO	pavia walnut	white																										
490	WENGÉ	BIANCO	wengé	white																										
503	ROVERE	ANTRACITE	oak	anthracite																										
504	ROVERE GREY	ANTRACITE	grey oak	anthracite																										
521	ACERO TAKI	ANTRACITE	taki maple	anthracite																										
541	BIANCO BR.	ANTRACITE	br. white	anthracite																										
544	STONE GREY	ANTRACITE	stone grey	anthracite																										
566	NOCE PAVIA	ANTRACITE	pavia walnut	anthracite																										
591	WENGÉ	ANTRACITE	wengé	anthracite																										
803	ROVERE	STONE GREY	oak	stone grey																										
804	ROVERE GREY	STONE GREY	grey oak	stone grey																										
820	ACERO TAKI	STONE GREY	taki maple	stone grey																										
840	BIANCO BR.	STONE GREY	br. white	stone grey																										
844	STONE GREY	STONE GREY	stone grey	stone grey																										
866	NOCE PAVIA	STONE GREY	pavia walnut	stone grey																										
890	WENGÉ	STONE GREY	wengé	stone grey																										

**SCRIVANIE DIREZIONALI (PIANI IN VETRO FLOAT SP. MM 10 RETROLACCATO)***executive desks (square edged rear-lacquered float glazed tops thick. 10mm)*

DESCRIZIONE <i>description</i>	L w	CODICE <i>code</i>	KG	M <sup>3</sup>	COLLI	PREZZO <i>price</i>	(*) CODICE FINITURA <i>(*) finish code</i>																																																																																										
SCRIVANIE DIREZIONALI PIANO IN VETRO E GAMBE A PONTE <i>executive desks with glass top and bridge legs</i>							<table border="1"> <thead> <tr> <th>★</th> <th colspan="4">GAMBE VERNICIATE / <i>painted legs</i></th> </tr> <tr> <th>(*)</th> <th>PIANO</th> <th>STRUTTURA</th> <th>top</th> <th>structure</th> </tr> </thead> <tbody> <tr><td>012</td><td>NERO</td><td>ARGENTO</td><td>black</td><td>silver</td></tr> <tr><td>072</td><td>TORTORA</td><td>ARGENTO</td><td>grey beige</td><td>silver</td></tr> <tr><td>074</td><td>ROSSO RUBINO</td><td>ARGENTO</td><td>ruby red</td><td>silver</td></tr> <tr><td>079</td><td>BIANCO</td><td>ARGENTO</td><td>white</td><td>silver</td></tr> <tr><td>412</td><td>NERO</td><td>BIANCO</td><td>black</td><td>white</td></tr> <tr><td>472</td><td>TORTORA</td><td>BIANCO</td><td>grey beige</td><td>white</td></tr> <tr><td>474</td><td>ROSSO RUBINO</td><td>BIANCO</td><td>ruby red</td><td>white</td></tr> <tr><td>479</td><td>BIANCO</td><td>BIANCO</td><td>white</td><td>white</td></tr> <tr><td>552</td><td>NERO</td><td>ANTRACITE</td><td>black</td><td>anthracite</td></tr> <tr><td>554</td><td>ROSSO RUBINO</td><td>ANTRACITE</td><td>ruby red</td><td>anthracite</td></tr> <tr><td>572</td><td>TORTORA</td><td>ANTRACITE</td><td>grey beige</td><td>anthracite</td></tr> <tr><td>579</td><td>BIANCO</td><td>ANTRACITE</td><td>white</td><td>anthracite</td></tr> <tr><td>812</td><td>NERO</td><td>STONE GREY</td><td>black</td><td>stone grey</td></tr> <tr><td>872</td><td>TORTORA</td><td>STONE GREY</td><td>grey beige</td><td>stone grey</td></tr> <tr><td>874</td><td>ROSSO RUBINO</td><td>STONE GREY</td><td>ruby red</td><td>stone grey</td></tr> <tr><td>879</td><td>BIANCO</td><td>STONE GREY</td><td>white</td><td>stone grey</td></tr> </tbody> </table>	★	GAMBE VERNICIATE / <i>painted legs</i>				(*)	PIANO	STRUTTURA	top	structure	012	NERO	ARGENTO	black	silver	072	TORTORA	ARGENTO	grey beige	silver	074	ROSSO RUBINO	ARGENTO	ruby red	silver	079	BIANCO	ARGENTO	white	silver	412	NERO	BIANCO	black	white	472	TORTORA	BIANCO	grey beige	white	474	ROSSO RUBINO	BIANCO	ruby red	white	479	BIANCO	BIANCO	white	white	552	NERO	ANTRACITE	black	anthracite	554	ROSSO RUBINO	ANTRACITE	ruby red	anthracite	572	TORTORA	ANTRACITE	grey beige	anthracite	579	BIANCO	ANTRACITE	white	anthracite	812	NERO	STONE GREY	black	stone grey	872	TORTORA	STONE GREY	grey beige	stone grey	874	ROSSO RUBINO	STONE GREY	ruby red	stone grey	879	BIANCO	STONE GREY	white	stone grey
	★	GAMBE VERNICIATE / <i>painted legs</i>																																																																																															
(*)	PIANO	STRUTTURA	top	structure																																																																																													
012	NERO	ARGENTO	black	silver																																																																																													
072	TORTORA	ARGENTO	grey beige	silver																																																																																													
074	ROSSO RUBINO	ARGENTO	ruby red	silver																																																																																													
079	BIANCO	ARGENTO	white	silver																																																																																													
412	NERO	BIANCO	black	white																																																																																													
472	TORTORA	BIANCO	grey beige	white																																																																																													
474	ROSSO RUBINO	BIANCO	ruby red	white																																																																																													
479	BIANCO	BIANCO	white	white																																																																																													
552	NERO	ANTRACITE	black	anthracite																																																																																													
554	ROSSO RUBINO	ANTRACITE	ruby red	anthracite																																																																																													
572	TORTORA	ANTRACITE	grey beige	anthracite																																																																																													
579	BIANCO	ANTRACITE	white	anthracite																																																																																													
812	NERO	STONE GREY	black	stone grey																																																																																													
872	TORTORA	STONE GREY	grey beige	stone grey																																																																																													
874	ROSSO RUBINO	STONE GREY	ruby red	stone grey																																																																																													
879	BIANCO	STONE GREY	white	stone grey																																																																																													
<b>GAMBE VERNICIATE / <i>painted legs</i></b>						★																																																																																											
L.180	153	<b>916 (*)</b>	64	0,256	5	€ <b>830,00</b>																																																																																											
L.200	153	<b>920 (*)</b>	70	0,283	5	€ <b>857,00</b>																																																																																											
						○																																																																																											
<b>GAMBE CROMATE / <i>chromed legs</i></b>						○																																																																																											
L.180	153	<b>931 (*)</b>	64	0,256	5	€ <b>1.154,00</b>																																																																																											
L.200	153	<b>932 (*)</b>	70	0,283	5	€ <b>1.181,00</b>																																																																																											
						○																																																																																											
<b>GAMBE CROMATE / <i>chromed legs</i></b>						○																																																																																											
L.180	153	<b>934 (*)</b>	62	0,256	5	€ <b>1.286,00</b>																																																																																											
L.200	153	<b>935 (*)</b>	68	0,283	5	€ <b>1.313,00</b>																																																																																											
						○																																																																																											
<b>GAMBE VERNICIATE / <i>painted legs</i></b>						★																																																																																											
L.180	153	<b>921 (*)</b>	62	0,256	5	€ <b>922,00</b>																																																																																											
L.200	153	<b>922 (*)</b>	68	0,283	5	€ <b>949,00</b>																																																																																											
						○																																																																																											
<b>GAMBE CROMATE / <i>chromed legs</i></b>						○																																																																																											
L.180	153	<b>934 (*)</b>	62	0,256	5	€ <b>1.286,00</b>																																																																																											
L.200	153	<b>935 (*)</b>	68	0,283	5	€ <b>1.313,00</b>																																																																																											
						○																																																																																											
<b>GAMBE CROMATE / <i>chromed legs</i></b>						○																																																																																											
L.180	153	<b>934 (*)</b>	62	0,256	5	€ <b>1.286,00</b>																																																																																											
L.200	153	<b>935 (*)</b>	68	0,283	5	€ <b>1.313,00</b>																																																																																											

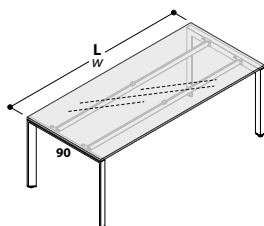

L. x p.90 x H.72,8

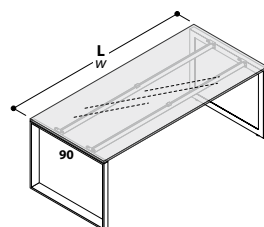

L. x p.90 x H.72,8





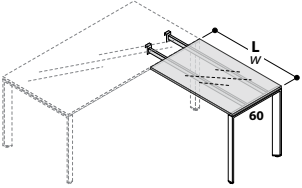
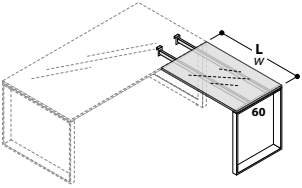

**ALLUNGHI (PIANI IN VETRO FLOAT SP. MM 10 RETROLACCATO)**  
*extensions (square edged rear-lacquered float glazed tops thick. 10mm)*

DESCRIZIONE <i>description</i>	L w	CODICE code	KG	M <sup>3</sup>	COLLI	PREZZO price	(*) CODICE FINITURA (*) finish code	
ALLUNGHI DX O SX PIANO IN VETRO E GAMBA A PONTE <i>right or left extensions with glass top and bridge leg</i>							★	<b>GAMBE VERNICIATE / painted legs</b>
							(*)	PIANO STRUTTURA top structure
							012	NERO ARGENTO black silver
							072	TORTORA ARGENTO grey beige silver
						074	ROSSO RUBINO ARGENTO ruby red silver	
						079	BIANCO ARGENTO white silver	
						412	NERO BIANCO black white	
						472	TORTORA BIANCO grey beige white	
						474	ROSSO RUBINO BIANCO ruby red white	
						479	BIANCO BIANCO white white	
						552	NERO ANTRACITE black anthracite	
						554	ROSSO RUBINO ANTRACITE ruby red anthracite	
						572	TORTORA ANTRACITE grey beige anthracite	
						579	BIANCO ANTRACITE white anthracite	
						812	NERO STONE GREY black stone grey	
						872	TORTORA STONE GREY grey beige stone grey	
						874	ROSSO RUBINO STONE GREY ruby red stone grey	
						879	BIANCO STONE GREY white stone grey	
						★		
						○	<b>GAMBE CROMATE / chromed legs</b>	
						(*)	PIANO STRUTTURA top structure	
						912	NERO CROMATO black chromed	
						974	ROSSO RUBINO CROMATO ruby red chromed	
						972	TORTORA CROMATO grey beige chromed	
						979	BIANCO CROMATO white chromed	
						○		
						★	<b>GAMBE VERNICIATE / painted legs</b>	
						(*)	PIANO STRUTTURA top structure	
						012	NERO ARGENTO black silver	
						072	TORTORA ARGENTO grey beige silver	
						074	ROSSO RUBINO ARGENTO ruby red silver	
						079	BIANCO ARGENTO white silver	
						412	NERO BIANCO black white	
						472	TORTORA BIANCO grey beige white	
						474	ROSSO RUBINO BIANCO ruby red white	
						479	BIANCO BIANCO white white	
						552	NERO ANTRACITE black anthracite	
						554	ROSSO RUBINO ANTRACITE ruby red anthracite	
						572	TORTORA ANTRACITE grey beige anthracite	
						579	BIANCO ANTRACITE white anthracite	
						812	NERO STONE GREY black stone grey	
						872	TORTORA STONE GREY grey beige stone grey	
						874	ROSSO RUBINO STONE GREY ruby red stone grey	
						879	BIANCO STONE GREY white stone grey	
						○	<b>GAMBE CROMATE / chromed legs</b>	
						(*)	PIANO STRUTTURA top structure	
						912	NERO CROMATO black chromed	
						974	ROSSO RUBINO CROMATO ruby red chromed	
						972	TORTORA CROMATO grey beige chromed	
						979	BIANCO CROMATO white chromed	
L. x p.60 x H.72,8							★	
ALLUNGHI DX O SX PIANO IN VETRO E GAMBA A "LOOP" <i>right or left extensions with glass top and "loop" leg</i>							★	<b>GAMBE VERNICIATE / painted legs</b>
							(*)	PIANO STRUTTURA top structure
							012	NERO ARGENTO black silver
							072	TORTORA ARGENTO grey beige silver
						074	ROSSO RUBINO ARGENTO ruby red silver	
						079	BIANCO ARGENTO white silver	
						412	NERO BIANCO black white	
						472	TORTORA BIANCO grey beige white	
						474	ROSSO RUBINO BIANCO ruby red white	
						479	BIANCO BIANCO white white	
						552	NERO ANTRACITE black anthracite	
						554	ROSSO RUBINO ANTRACITE ruby red anthracite	
						572	TORTORA ANTRACITE grey beige anthracite	
						579	BIANCO ANTRACITE white anthracite	
						812	NERO STONE GREY black stone grey	
						872	TORTORA STONE GREY grey beige stone grey	
						874	ROSSO RUBINO STONE GREY ruby red stone grey	
						879	BIANCO STONE GREY white stone grey	
						○	<b>GAMBE CROMATE / chromed legs</b>	
						(*)	PIANO STRUTTURA top structure	
						912	NERO CROMATO black chromed	
						974	ROSSO RUBINO CROMATO ruby red chromed	
						972	TORTORA CROMATO grey beige chromed	
						979	BIANCO CROMATO white chromed	
L. x p.60 x H.72,8							○	

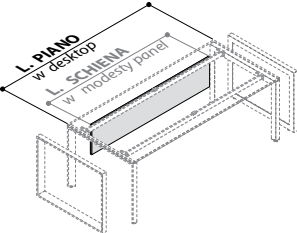

**SCHIENE PER SCRIVANIE DIREZIONALI CON PIANO IN VETRO***modesty panels for executive desks with glazed top*

DESCRIZIONE <i>description</i>	L <i>w</i>	L <i>w</i>	CODICE <i>code</i>	KG 	M <sup>3</sup> 	COLLI 	PREZZO <i>price</i>	(*) CODICE FINITURA <i>(*) finish code</i>																									
SCHIENE PER SCRIVANIE DIREZIONALI CON PIANO IN VETRO <i>modesty panels for executive desks with glass top</i>    L. x p.1,8 x H.31,1	<table border="1"> <thead> <tr> <th>L. SCHIENA <i>w modesty</i></th> <th>UTILIZZARE SU PIANI <i>use for desktops</i></th> </tr> </thead> <tbody> <tr> <td>L.159</td> <td>L.180</td> </tr> <tr> <td>L.179</td> <td>L.200</td> </tr> </tbody> </table>		L. SCHIENA <i>w modesty</i>	UTILIZZARE SU PIANI <i>use for desktops</i>	L.159	L.180	L.179	L.200	<table border="1"> <thead> <tr> <th>(*)</th> <th>SCHIENA</th> <th><i>modesty panel</i></th> </tr> </thead> <tbody> <tr> <td>000</td> <td>ARGENTO GOLF</td> <td><i>golf silver</i></td> </tr> <tr> <td>400</td> <td>BIANCO BR.</td> <td><i>br. white</i></td> </tr> <tr> <td>551</td> <td>ANTRACITE</td> <td><i>anthracite</i></td> </tr> <tr> <td>844</td> <td>STONE GREY</td> <td><i>stone grey</i></td> </tr> </tbody> </table>		(*)	SCHIENA	<i>modesty panel</i>	000	ARGENTO GOLF	<i>golf silver</i>	400	BIANCO BR.	<i>br. white</i>	551	ANTRACITE	<i>anthracite</i>	844	STONE GREY	<i>stone grey</i>	<table border="1"> <thead> <tr> <th>PREZZO</th> <th>PREZZO</th> </tr> </thead> <tbody> <tr> <td>€ 34,00</td> <td>€ 35,00</td> </tr> </tbody> </table>		PREZZO	PREZZO	€ 34,00	€ 35,00		
	L. SCHIENA <i>w modesty</i>	UTILIZZARE SU PIANI <i>use for desktops</i>																															
	L.159	L.180																															
	L.179	L.200																															
	(*)	SCHIENA	<i>modesty panel</i>																														
000	ARGENTO GOLF	<i>golf silver</i>																															
400	BIANCO BR.	<i>br. white</i>																															
551	ANTRACITE	<i>anthracite</i>																															
844	STONE GREY	<i>stone grey</i>																															
PREZZO	PREZZO																																
€ 34,00	€ 35,00																																
 UTILIZZARE SOLO SU SCRIVANIE CON PIANO IN VETRO <i>use under desks with glass top</i>																																	

## MOBILI DI SERVIZIO SU PIEDINI

service units on adjustable feet

PER CASSETTIERE SU RUOTE VEDI PAG.57  
for pedestals on wheels, please see page 57

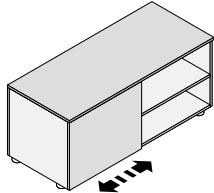
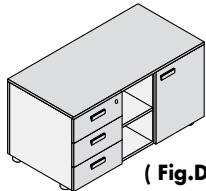
DESCRIZIONE <i>description</i>	CODICE <i>code</i>	KG	M <sup>3</sup>	COLLI	PREZZO <i>price</i>	(*) CODICE FINITURA <i>(*) finish code</i>	
MOBILE DI SERVIZIO L.140 TERMINALE DX O SX CON ANTINA SCORREVOLE E VANO A GIORNO <i>right or left terminal service unit w 140 cms with sliding door and open compartment</i>    L.140 x p.60 x H.61,5	152	47	0,167	2	€ 264,00	VERSIONE MONO-COLORE / <i>single-color version</i>	
						(*)	ARGENTO GOLF
						400 BIANCO BR. <i>br. white</i>	
						551 ANTRACITE <i>anthracite</i>	
						844 STONE GREY <i>stone grey</i>	
						VERSIONE BI-COLORE / <i>double-color version</i>	
						(*) FRONTALI + SCHIENA + TOP STRUTTURA <i>fronts + back panel + top structure</i>	
						003 ROVERE ARGENTO GOLF oak <i>golf silver</i>	
						004 ROVERE GREY ARGENTO GOLF grey oak <i>golf silver</i>	
						011 GIALLO FRESIA ARGENTO GOLF <i>freesia yellow golf silver</i>	
						020 ACERO TAKI ARGENTO GOLF <i>taki maple golf silver</i>	
						032 AZZURRO SKY ARGENTO GOLF <i>sky blue golf silver</i>	
						033 AMARANTO ARGENTO GOLF <i>amaranth golf silver</i>	
						040 BIANCO BR. ARGENTO GOLF <i>br. white golf silver</i>	
						044 STONE GREY ARGENTO GOLF <i>stone grey golf silver</i>	
						051 ANTRACITE ARGENTO GOLF <i>anthracite golf silver</i>	
						066 NOCE PAVIA ARGENTO GOLF <i>pavia walnut golf silver</i>	
						090 WENGÈ ARGENTO GOLF <i>wengè golf silver</i>	
						096 VERDE BOSCO ARGENTO GOLF <i>wood green golf silver</i>	
						403 ROVERE BIANCO BR. oak <i>br. white</i>	
						404 ROVERE GREY BIANCO BR. grey oak <i>br. white</i>	
						405 ARGENTO GOLF BIANCO BR. <i>golf silver br. white</i>	
						411 GIALLO FRESIA BIANCO BR. <i>freesia yellow br. white</i>	
						420 ACERO TAKI BIANCO BR. <i>taki maple br. white</i>	
						432 AZZURRO SKY BIANCO BR. <i>sky blue br. white</i>	
						433 AMARANTO BIANCO BR. <i>amaranth br. white</i>	
						444 STONE GREY BIANCO BR. <i>stone grey br. white</i>	
						451 ANTRACITE BIANCO BR. <i>anthracite br. white</i>	
						466 NOCE PAVIA BIANCO BR. <i>pavia walnut br. white</i>	
						490 WENGÈ BIANCO BR. <i>wengè br. white</i>	
						496 VERDE BOSCO BIANCO BR. <i>wood green br. white</i>	
						503 ROVERE ANTRACITE oak <i>anthracite</i>	
						504 ROVERE GREY ANTRACITE grey oak <i>anthracite</i>	
						506 ARGENTO GOLF ANTRACITE <i>golf silver anthracite</i>	
						511 GIALLO FRESIA ANTRACITE <i>freesia yellow anthracite</i>	
						521 ACERO TAKI ANTRACITE <i>taki maple anthracite</i>	
						532 AZZURRO SKY ANTRACITE <i>sky blue anthracite</i>	
						533 AMARANTO ANTRACITE <i>amaranth anthracite</i>	
						541 BIANCO BR. ANTRACITE <i>br. white anthracite</i>	
						544 STONE GREY ANTRACITE <i>stone grey anthracite</i>	
						566 NOCE PAVIA ANTRACITE <i>pavia walnut anthracite</i>	
						591 WENGÈ ANTRACITE <i>wengè anthracite</i>	
						596 VERDE BOSCO ANTRACITE <i>wood green anthracite</i>	
						803 ROVERE STONE GREY oak <i>stone grey</i>	
						804 ROVERE GREY STONE GREY grey oak <i>stone grey</i>	
						805 ARGENTO GOLF STONE GREY <i>golf silver stone grey</i>	
						811 GIALLO FRESIA STONE GREY <i>freesia yellow stone grey</i>	
						820 ACERO TAKI STONE GREY <i>taki maple stone grey</i>	
						832 AZZURRO SKY STONE GREY <i>sky blue stone grey</i>	
						833 AMARANTO STONE GREY <i>amaranth stone grey</i>	
						840 BIANCO BR. STONE GREY <i>br. white stone grey</i>	
						851 ANTRACITE STONE GREY <i>anthracite stone grey</i>	
						866 NOCE PAVIA STONE GREY <i>pavia walnut stone grey</i>	
						890 WENGÈ STONE GREY <i>wengè stone grey</i>	
						896 VERDE BOSCO STONE GREY <i>wood green stone grey</i>	
MOBILE DI SERVIZIO L.120 CON 3 CASSETTI, VANO A GIORNO E 1 ANTA CIECA <i>service unit w 120 cms with 3 drawers, open compartment and 1 wooden door</i>   ( Fig.DX/ right )  L.120 x p.52,5 x H.61,5						CASSETTI IN LEGNO <i>wooden drawers</i>	
	DX <i>right</i>	152	778 (*)	41	0,390	1	€ 347,00
	SX <i>left</i>	152	779 (*)				



# Bench

## • PANNELLI FRONTALI

MATERIALE: Pannello di particelle di legno sp. 25mm o metacrilato sp. 5 mm

FINITURA: Disponibile in 3 tipologie

1) Nobilitato in melaminico: Argento Golf, Acero Taki, Bianco Br., Wengè, Noce Pavia, Stone grey, Rovere, Rovere grey, Antracite

2) Rivestito in tessuto, colori Forsit (Cat. F) :

Poliestere Stretch Ignifugo

3) Metacrilato: bianco

CARATTERISTICA: Dotato di binario o barra attrezzabile per alloggiamento accessori.

## • FRONT PANELS

MATERIAL: Particleboard panel 25mm thick. or methacrylate 5mm thick.

FINISH: Available in 3 kinds:

1) Melamine-faced: Golf Silver, Taki Maple, Br. White, Wengè, Pavia walnut, Stone grey, Oak, Grey oak, Anthracite

2) Covered by fabric, Forsit colours (Cat. F):

Fire-retardant Stretch Polyester

3) Methacrylate: White

FEATURE: Binary or aluminium toolbar included to hook-up the accessories.

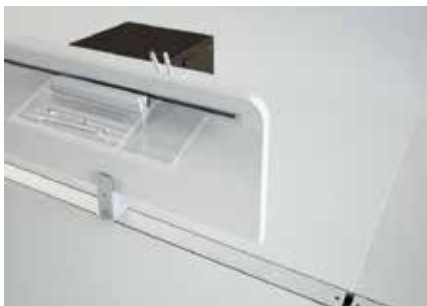

## • MOBILI DI SERVIZIO E PORTA-CPU

MATERIALE: Pannello di particelle di legno sp. 18mm

FINITURA: Nobilitato in melaminico

COLORI:

Struttura: Argento Golf, Bianco Br., Antracite, Stone grey,

Frontali, top e schiena: Antracite, Acero Taki, Bianco Br., Wengè,

Noce Pavia, Stone grey, Rovere, Rovere grey, Argento Golf, Giallo

fresia, Azzurro sky, Amaranth, Verde bosco.

CARATTERISTICA: Consente l'alloggiamento del PC-Tower

e il cablaggio tramite aperture sulla base. Dotato di piedini

livellatori. Possibilità di utilizzo come freestanding.

## • SERVICE UNITS AND CPU-HOLDER

MATERIAL: Particleboard panel 18 mm thick.

FINISH: Melamine-faced

COLOURS:

Structure: Golf Silver, Br. White, Anthracite, Stone grey

Fronts, top and back panel: Anthracite, Taki Maple, Br. White,

Wengè, Pavia walnut, Stone grey, Oak, Grey oak, Golf Silver,

Freesia yellow, Sky blue, Amaranth, Wood green

FEATURE: It allows the PC-Tower lodging and the wire-manager

through a bottom opening.

Adjustable feet included. The service units can be used as freestanding.

# 5<sup>TH</sup> ELEMENT

## • PIANI DI LAVORO

**MATERIALE:** Pannello di particelle di legno sp. 18mm (possibilità di utilizzo pannelli di sp. 25mm)  
**FINITURA:** Nobilitato in melaminico  
**COLORI:** Acero Taki, Bianco Br., Wengè, Noce Pavia, Stone grey, Rovere, Rovere grey.

## • WORK TOPS

**MATERIAL:** Particleboard panel 18mm thick. (25mm thick. tops available )  
**FINISH:** Melamine-faced  
**COLOURS:** Taki Maple, Br. White, Wengè, Pavia walnut, Stone grey, Oak, Grey oak.



## • GAMBA METALLICA A PONTE

**MATERIALE:** Tubolare metallico a sezione trapezoidale  
**FINITURA:** Verniciatura a polveri epossidiche nei colori: Argento, Bianco, Antracite, Stone grey  
**CARATTERISTICA:** Predisposta per il fissaggio delle travi portanti. Dotata di piedini livellatori.

## • BRIDGE METAL LEG

**MATERIAL:** Metallic tubular with trapezoidal section  
**FINISH:** Painted with epoxy resin powder in colours: Silver, White, Anthracite  
**FEATURE:** The leg is predisposed for to fix the supporting beams. Adjustable feet included.



## • TRAVI DI SOSTEGNO

**MATERIALE:** Tubolare metallico a sezione rettangolare  
**FINITURA:** Verniciatura a polveri epossidiche nei colori Argento, Bianco, Antracite, Stone grey.  
**CARATTERISTICA:** Predisposte per il fissaggio delle gambe ponte e dei piani.

## • SUPPORTING BEAMS

**MATERIAL:** Metallic tubular with rectangular section  
**FINISH:** Painted with epoxy resin powder in colours Silver, White, Anthracite, Stone grey.  
**FEATURE:** The beams are predisposed for to fix the bridge legs and the work tops.



## • GAMBA CENTRALE WIRE-MANAGER

**MATERIALE:** Struttura in tubolare metallico e pannelli di tamponamento in lamiera metallica  
**FINITURA:** Verniciatura a polveri epossidiche nei colori: Argento, Bianco, Antracite, Stone grey  
**CARATTERISTICA:** Consente il cablaggio tramite aperture laterali. Dotata di pannelli laterali ispezionabili. Predisposta per il fissaggio delle travi portanti e dei piani. Dotata di piedini livellatori.

## • CENTRAL WIRE-MANAGER LEG

**MATERIAL:** Metallic tubular structure and panels in metal sheet.  
**FINISH:** Painted with epoxy resin powder in colours: Silver, White, Anthracite, Stone grey  
**FEATURE:** It allows the wire-manager through a lateral opening. The leg is predisposed for to fix the supporting beams and the work tops. Adjustable feet included.

# Bench

## • PORTA-CPU

MATERIALE: Pannello di particelle di legno sp. 18mm

FINITURA: Nobilitato in melaminico

COLORI:

Struttura: Argento Golf, Bianco Br., Antracite, Stone grey

Top e schiena: Antracite, Acero Taki, Bianco Br., Wengè, Noce Pavia, Stone grey, Rovere, Rovere grey, Argento Golf, Giallo fresia, Azzurro sky, Amaranto, Verde bosco.

CARATTERISTICA: Consente l'alloggiamento del PC-Tower e il cablaggio tramite aperture sulla base.

Dotato di piedini livellatori.

Possibilità di utilizzo come sostegno strutturale sottopiano, completando la composizione, con staffe fornite separatamente.



## • CPU-HOLDER

MATERIAL: Particleboard panel 18 mm thick.

FINISH: Melamine-faced

COLOURS:

Structure: Golf Silver, Br. White, Anthracite, Stone grey

Top and back panel: Anthracite, Taki Maple, Br. White, Wengè, Pavia walnut, Stone grey, Oak, Grey oak, Golf Silver, Freesia, Sky blue, Amaranth, Wood green.

FEATURE: It allows the PC-Tower lodging and the wire-manager through a bottom opening.

Adjustable feet included.

The CPU-holder can be used as support (with stirrups not included in the box).



## • COPERTURA PER BENCH

MATERIALE: Profilo in plastica estrusa

COLORE: Argento

CARATTERISTICA: Predisposizione per il fissaggio di pannelli frontali, mensole e lampade.

## • COVER FOR BENCH

MATERIAL: Extruded plastic profile

COLOURS: Silver

FEATURE: It is predisposed for to fix the front panels, shelves and lamps.





# 5<sup>TH</sup> ELEMENT

## • TRAVI DI SOSTEGNO

MATERIALE: Tubolare metallico a sezione rettangolare

FINITURA: Verniciatura a polveri epossidiche nei colori Argento, Bianco, Antracite, Stone grey.

CARATTERISTICA: Predisposte per il fissaggio delle gambe ponte e dei piani.

## • SUPPORTING BEAMS

MATERIAL: Metallic tubular with rectangular section

FINISH: Painted with epoxy resin powder in colours Silver, White, Anthracite, Stone grey.

FEATURE: The beams are predisposed for to fix the bridge legs and the tops.



## • MOBILI DI SERVIZIO CON ANTA SCORREVOLE

MATERIALE: Pannello di particelle di legno sp. 18mm

FINITURA: Nobilitato in melaminico

COLORI:

Struttura: Argento Golf, Bianco Br., Antracite, Stone grey

Frontali, top e schiena: Antracite, Acero Taki, Bianco Br., Wengè, Noce Pavia, Stone grey, Rovere, Rovere grey, Argento Golf, Giallo fresia, Azzurro sky, Amaranto, Verde bosco.

CARATTERISTICA:

Con vano porta-oggetti e anta scorrevole.

Disponibile mono-facciale e bi-facciale. Dotato di piedini livellatori.

Possibilità di utilizzo come freestanding o come sostegno strutturale sottopiano.



## • SERVICE UNITS WITH SLIDING DOOR

MATERIAL: Particleboard panel 18 mm thick.

FINISH: Melamine-faced

COLOURS:

Structure: Golf Silver, Br. White, Anthracite, Stone grey

Fronts, top and back panel: Anthracite, Taki Maple, Br. White, Wengè, Pavia walnut, Stone grey, Oak, Grey oak, Golf Silver, Freesia yellow, Sky blue, Amaranth, Wood green.

FEATURE:

With glove-compartment and sliding door.

It is available one-side or double-side. Adjustable feet included.

The service units can be used as freestanding or to support.

**ESEMPI DI AGGREGAZIONE SCRIVANIE CON GAMBE A PONTE E TIPO BENCH**  
*examples of composition desks with bridge metal legs and BENCH*

**BENCH (1 POSTAZIONE)**  
 bench (1 desk)

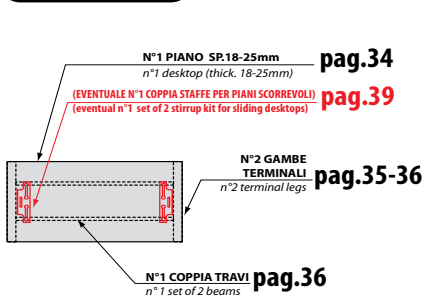

**BENCH (3 POSTAZIONI)**  
 bench (3 desk)

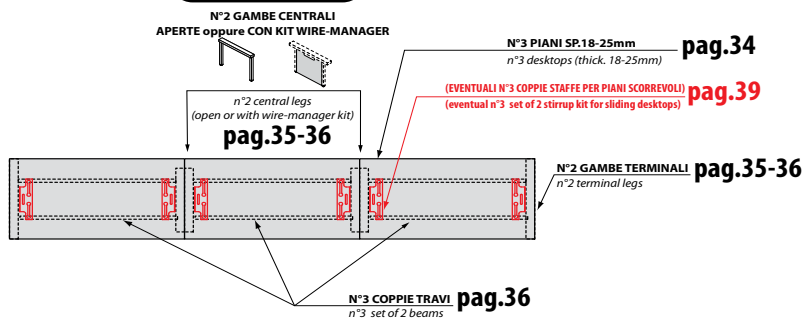

**BENCH (2 POSTAZIONI)**  
 bench (2 desk)

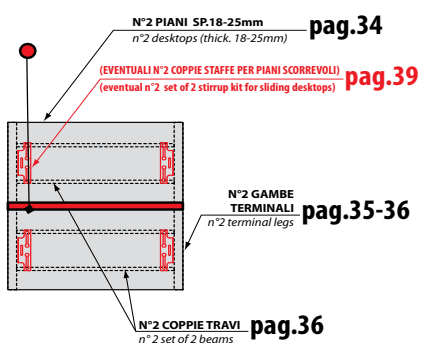

**BENCH (6 POSTAZIONI)**  
 bench (6 desk)

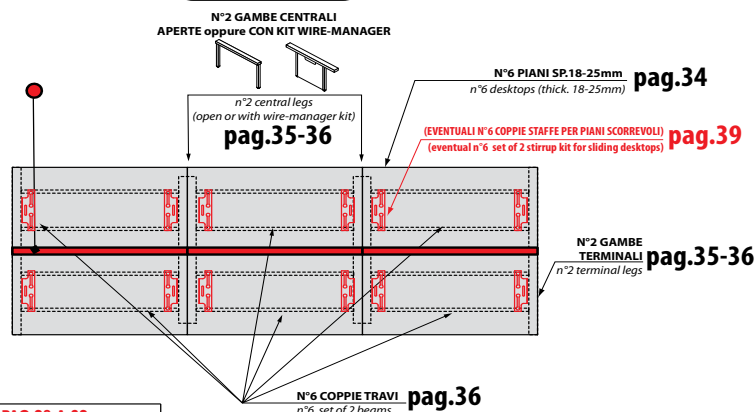

● PER COPERTURE CENTRALI e PANNELLI FRONTALI VEDI DA PAG.28 A 32  
 for central covers and front panels, please see pages from 28 to 32

**• ESEMPIO ELETTRIFICAZIONE COMPLESSIVA DEL BENCH**  
 • EXAMPLE ELECTRIFICATION BENCH

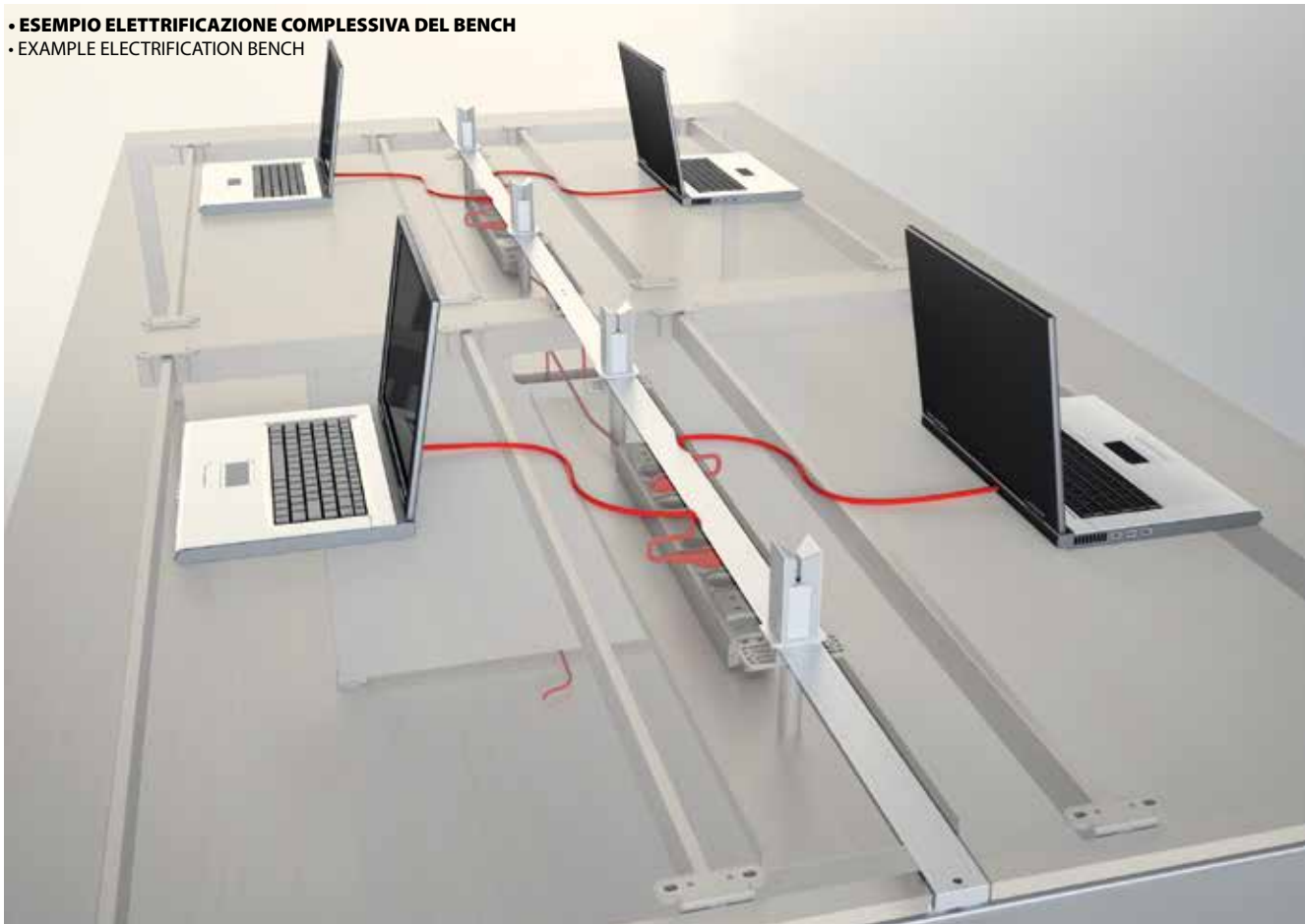

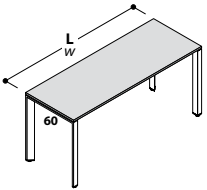
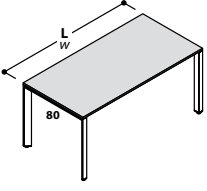
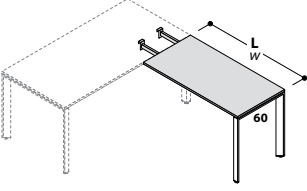
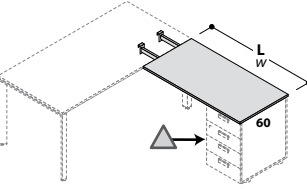
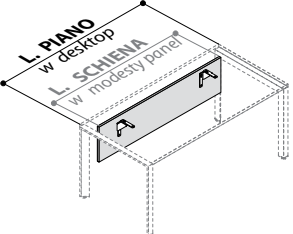
<b>SCRIVANIE SINGOLE CON GAMBE METALLICHE A PONTE (PIANI SP. 18mm)</b> <i>single desks with bridge metal legs (tops thick. 18mm)</i>								
DESCRIZIONE <i>description</i>	L <i>w</i>	CODICE <i>code</i>	KG	M <sup>3</sup>	COLLI	PREZZO <i>price</i>	(*) CODICE FINITURA <i>(*) finish code</i>	
<b>SCRIVANIE PROF. CM 60</b> <i>desks deep 60 cms</i> 	L.120	<b>153 003 (*)</b>	28	0,127	4	€ 304,00		
	L.140	<b>153 004 (*)</b>	30	0,136	4	€ 316,00		
	L.160	<b>153 005 (*)</b>	33	0,143	4	€ 329,00		
	L.180	<b>153 006 (*)</b>	36	0,148	4	€ 342,00		
	L. x p. <b>60</b> x H.72,8							
<b>SCRIVANIE PROF. CM 80</b> <i>desks deep 80 cms</i> 	L.120	<b>153 020 (*)</b>	33	0,163	4	€ 335,00		
	L.140	<b>153 021 (*)</b>	34	0,173	4	€ 348,00		
	L.160	<b>153 022 (*)</b>	37	0,182	4	€ 361,00		
	L.180	<b>153 023 (*)</b>	40	0,188	4	€ 378,00		
	L. x p. <b>80</b> x H.72,8							
<b>ALLUNGHI</b> <i>extensions</i> 	L.80	<b>153 013 (*)</b>	17	0,084	4	€ 236,00		
	L.100	<b>153 014 (*)</b>	20	0,094	4	€ 248,00		
	L.120	<b>153 010 (*)</b>	24	0,102	4	€ 259,00		
	L. x p. <b>60</b> x H.72,8							
<b>ALLUNGHI PER CASSETTIERA-BASE</b> <i>extensions for base-pedestal</i> 	L.80	<b>153 018 (*)</b>	9,5	0,045	3	€ 124,00		
	L.100	<b>153 019 (*)</b>	12	0,052	3	€ 133,00		
	L.120	<b>153 015 (*)</b>	15	0,062	3	€ 136,00		
	L. x p. <b>60</b> x H.1,8							
<p style="text-align: center;"><b>COMPLETARE SEMPRE CON CASSETTIERA-BASE ART.764-775 PAG.59</b>  <i>to be always complete with base-pedestal art.764-775 page 59</i></p>								
<b>SCIENIE PER SCRIVANIE</b> <i>modesty panels for desks</i> 	L.107	L.120	<b>152 473 (*)</b>	7	0,020	2	€ 35,00	
	L.127	L.140	<b>152 474 (*)</b>	8	0,023	2	€ 37,00	
	L.147	L.160	<b>152 476 (*)</b>	9	0,026	2	€ 40,00	
	L.167	L.180	<b>152 477 (*)</b>	10	0,029	2	€ 43,00	
	L. x p. <b>1,8</b> x H.30							
<p style="text-align: center;"><b>LE SCIENIE NON SONO UTILIZZABILI IN PRESENZA DI PANNELLI FRONTALI</b>  <i>(pagina seguente)</i>  <b>DO NOT USE MODESTY PANEL TOGETHER WITH THE FRONT PANEL (NEXT PAGE)</b></p>								
		(*)	PIANO	STRUTTURA	top	structure		
		003	ROVERE	ARGENTO	oak	silver		
		004	ROVERE GREY	ARGENTO	grey oak	silver		
		020	ACERO TAKI	ARGENTO	taki maple	silver		
		040	BIANCO BR.	ARGENTO	br. white	silver		
		044	STONE GREY	ARGENTO	stone grey	silver		
		066	NOCE PAVIA	ARGENTO	pavia walnut	silver		
		090	'WENGE'	ARGENTO	wengè	silver		
		400	BIANCO BR.	BIANCO	br. white	white		
		403	ROVERE	BIANCO	oak	white		
		404	ROVERE GREY	BIANCO	grey oak	white		
		420	ACERO TAKI	BIANCO	taki maple	white		
		444	STONE GREY	BIANCO	stone grey	white		
		466	NOCE PAVIA	BIANCO	pavia walnut	white		
		490	'WENGE'	BIANCO	wengè	white		
		503	ROVERE	ANTRACITE	oak	anthracite		
		504	ROVERE GREY	ANTRACITE	grey oak	anthracite		
		521	ACERO TAKI	ANTRACITE	taki maple	anthracite		
		541	BIANCO BR.	ANTRACITE	br. white	anthracite		
		544	STONE GREY	ANTRACITE	stone grey	anthracite		
		566	NOCE PAVIA	ANTRACITE	pavia walnut	anthracite		
		591	'WENGE'	ANTRACITE	wengè	anthracite		
		803	ROVERE	STONE GREY	oak	stone grey		
		804	ROVERE GREY	STONE GREY	grey oak	stone grey		
		820	ACERO TAKI	STONE GREY	taki maple	stone grey		
		840	BIANCO BR.	STONE GREY	br. white	stone grey		
		844	STONE GREY	STONE GREY	stone grey	stone grey		
		866	NOCE PAVIA	STONE GREY	pavia walnut	stone grey		
		890	'WENGE'	STONE GREY	wengè	stone grey		
		(*)	SCIENIA	modesty panel				
		000	ARGENTO GOLF	golf silver				
		400	BIANCO BR.	br. white				
		551	ANTRACITE	anthracite				
		844	STONE GREY	stone grey				



### PANNELLI FRONTALI E ACCESSORI

front panels and accessories

DESCRIZIONE <i>description</i>	L <i>w</i>	L <i>w</i>	CODICE <i>code</i>	KG	M <sup>3</sup>	COLLI	PREZZO <i>price</i>	(*) CODICE FINITURA <i>(*) finish code</i>		
<p>PANNELLI FRONTALI <i>front panels</i></p>	<b>L. PANNELLO <i>w front pan.</i></b>	<b>UTILIZZARE SU PIANI <i>use for desktops</i></b>	<b>MELAMINICO <i>melamine</i></b>					(*)	MELAMINICO <i>melamine</i>	
	L.107	L.120	152 <b>483 (*)</b>	8	0,033	2	<b>€ 60,00</b>	000	ARGENTO GOLF <i>golf silver</i>	
	L.127	L.140	152 <b>484 (*)</b>	9	0,035	2	<b>€ 65,00</b>	166	NOCE PAVIA <i>pavia walnut</i>	
	L.147	L.160	152 <b>485 (*)</b>	10	0,032	2	<b>€ 70,00</b>	200	ACERO TAKI <i>taki maple</i>	
	L.167	L.180	152 <b>486 (*)</b>	11	0,044	2	<b>€ 75,00</b>	400	BIANCO BR. <i>br. white</i>	
								551	ANTRACITE <i>anthracite</i>	
								704	ROVERE GREY <i>grey oak</i>	
								733	ROVERE <i>oak</i>	
								844	STONE GREY <i>stone grey</i>	
								900	WENGE' <i>wenge</i>	
									(*)	TESSUTO POLIESTERE STRETCH IGNIFUGO <i>fire-retardant stretch polyester fabric</i>
									320	AZZURRO SKY <i>sky blue</i>
								321	GIALLO FRESIA <i>freesia yellow</i>	
								322	AMARANTO <i>amaranth</i>	
								323	VERDE BOSCO <i>wood green</i>	
								327	GRIGIO <i>grey</i>	
								328	TORTORA <i>grey beige</i>	
								330	MATONE <i>brick red</i>	
								331	ARANCIO <i>orange</i>	
								332	ROSSO <i>red</i>	
								333	VERDE ACIDO <i>acid green</i>	
								334	BLU <i>blue</i>	
<p><b>I PANNELLI FRONTALI NON SONO UTILIZZABILI IN PRESENZA DI SCHIENE</b> <b>DO NOT USE FRONT PANEL TOGETHER WITH THE MODESTY PANEL</b></p>										

L. x p.1,8 x H.46,5

<p>PORTA-PENNE <i>pen-holder</i></p>		L.8,5	152 <b>351 (*)</b>	1,5	0,002	2	<b>€ 30,00</b>		
L.8,5 x p.9,5 x H.9									

<p>PORTA-OGGETTI <i>objects-holder</i></p>		L.38	152 <b>352 (*)</b>	1,5	0,002	2	<b>€ 54,00</b>	(*)	ACCESSORI <i>accessories</i>
L.38 x p.15 x H.6									
								999	TRASPARENTE <i>transparent</i>

<p>KIT 2 PORTA-CARTA <i>set of 2 paper-holder</i></p>		L.35	152 <b>353 (*)</b>	1,5	0,002	2	<b>€ 69,00</b>		
L.35 x p.27 x H.6									

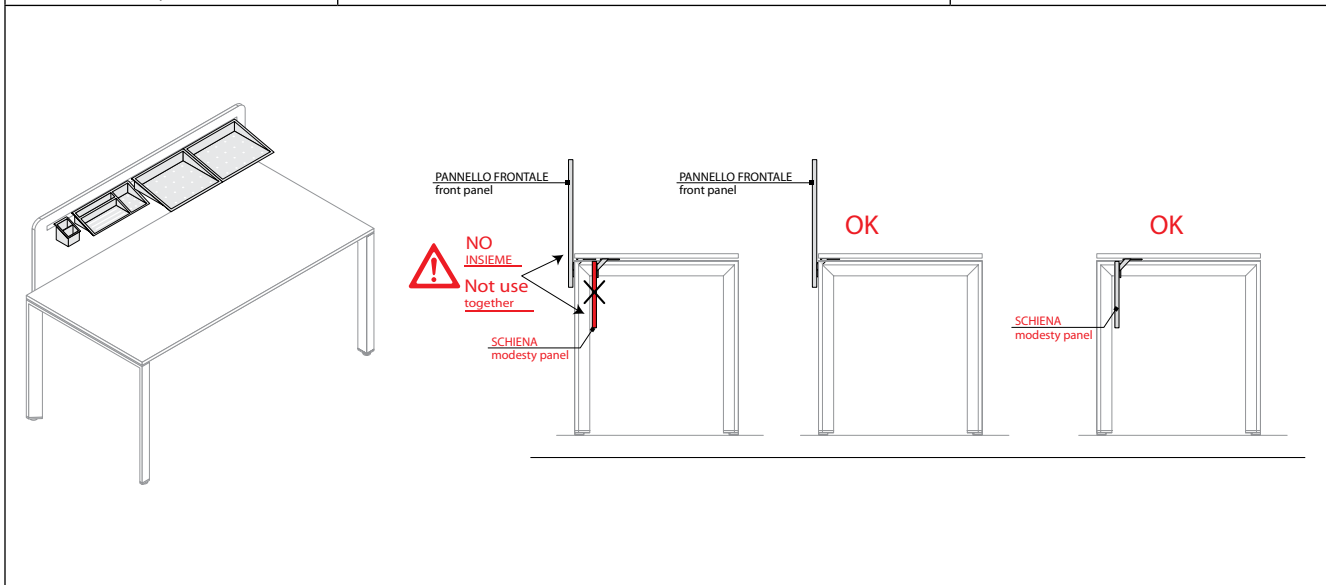

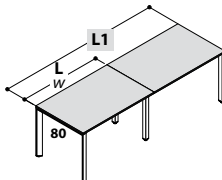
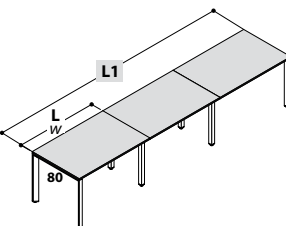
SCRIVANIE IN LINEA PROF.80 CON GAMBE A PONTE (PIANI SP. 18mm)									
linear desks deep 80 cms with bridge legs (tops thick. 18mm)									
DESCRIZIONE description	L1	L w	CODICE code	KG	M <sup>3</sup>	COLLI	PREZZO price	(*) CODICE FINITURA (*) finish code	
(2x) SCRIVANIE IN LINEA PROF. CM 80 (2x) linear desks deep 80 cms    L1 x p.80 x H.72,8	<b>L1</b>								
	L.240	L.120	153 <b>025</b> (*)	57	0,288	7	€ 535,00	(*)	PIANO STRUTTURA top structure
	L.280	L.140	153 <b>026</b> (*)	59	0,308	7	€ 561,00	003	ROVERE ARGENTO oak silver
	L.320	L.160	153 <b>027</b> (*)	65	0,326	7	€ 587,00	004	ROVERE GREY ARGENTO grey oak silver
	L.360	L.180	153 <b>028</b> (*)	71	0,340	7	€ 621,00	020	ACERO TAKI ARGENTO taki maple silver
	PER KIT WIRE-MANAGER GAMBA CENTRALE, VEDI ART. 737 A PAG.35 for wire-manager kit central leg, please see art.737 to page 35							040	BIANCO BR. ARGENTO br. white silver
								044	STONE GREY ARGENTO stone grey silver
								066	NOCE PAVIA ARGENTO pavia walnut silver
								090	WENGE' ARGENTO wengè silver
								400	BIANCO BR. BIANCO br. white white
								403	ROVERE BIANCO oak white
								404	ROVERE GREY BIANCO grey oak white
								420	ACERO TAKI BIANCO taki maple white
								444	STONE GREY BIANCO stone grey white
								466	NOCE PAVIA BIANCO pavia walnut white
								490	WENGE' BIANCO wengè white
								503	ROVERE ANTRACITE oak anthracite
								504	ROVERE GREY ANTRACITE grey oak anthracite
								521	ACERO TAKI ANTRACITE taki maple anthracite
								541	BIANCO BR. ANTRACITE br. white anthracite
								544	STONE GREY ANTRACITE stone grey anthracite
								566	NOCE PAVIA ANTRACITE pavia walnut anthracite
								591	WENGE' ANTRACITE wengè anthracite
								803	ROVERE STONE GREY oak stone grey
								804	ROVERE GREY STONE GREY grey oak stone grey
								820	ACERO TAKI STONE GREY taki maple stone grey
								840	BIANCO BR. STONE GREY br. white stone grey
								844	STONE GREY STONE GREY stone grey stone grey
								866	NOCE PAVIA STONE GREY pavia walnut stone grey
								890	WENGE' STONE GREY wengè stone grey
(3x) SCRIVANIE IN LINEA PROF. CM 80 (3x) linear desks deep 80 cms    L1 x p.80 x H.72,8	<b>L1</b>								
	L.360	L.120	153 <b>035</b> (*)	81	0,414	10	€ 735,00	820	ACERO TAKI STONE GREY taki maple stone grey
	L.420	L.140	153 <b>036</b> (*)	84	0,444	10	€ 774,00	840	BIANCO BR. STONE GREY br. white stone grey
	L.480	L.160	153 <b>037</b> (*)	93	0,471	10	€ 813,00	844	STONE GREY STONE GREY stone grey stone grey
	L.540	L.180	153 <b>038</b> (*)	102	0,491	10	€ 864,00	866	NOCE PAVIA STONE GREY pavia walnut stone grey
								890	WENGE' STONE GREY wengè stone grey
	PER KIT WIRE-MANAGER GAMBA CENTRALE, VEDI ART. 737 A PAG.35 for wire-manager kit central leg, please see art.737 to page 35								

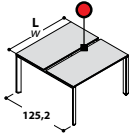
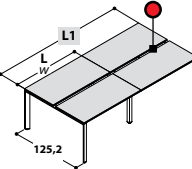
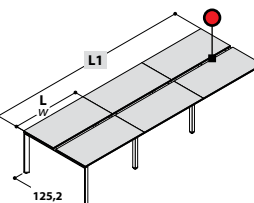
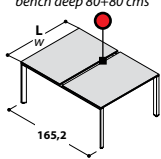
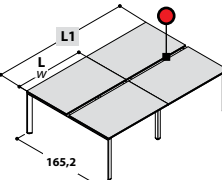
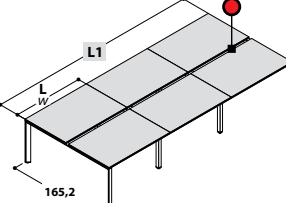
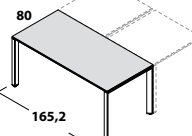
<b>BENCH PROF.60+60 (PIANI SP. 18mm)</b> <i>bench deep 60+60 cms (tops thick. 18mm)</i>													
DESCRIZIONE <i>description</i>	L1	L w	CODICE <i>code</i>	KG	M <sup>3</sup>	COLLI	PREZZO <i>price</i>	(*) CODICE FINITURA <i>(*) finish code</i>					
								(*)	PIANO	STRUTTURA	top	structure	
BENCH PROF. CM 60+60 <i>bench deep 60+60 cms</i>  L. x p.125,2 x H.72,8		L.120	153 055 (*)	50	0,261	6	€ 480,00	003	ROVERE	ARGENTO	oak	silver	
		L.140	153 056 (*)	54	0,277	6	€ 504,00	004	ROVERE GREY	ARGENTO	grey oak	silver	
		L.160	153 057 (*)	60	0,292	6	€ 530,00	020	ACERO TAKI	ARGENTO	taki maple	silver	
		L.180	153 058 (*)	66	0,302	6	€ 556,00	040	BIANCO BR.	ARGENTO	br. white	silver	
								044	STONE GREY	ARGENTO	stone grey	silver	
BENCH PROF. CM 60+60 <i>bench deep 60+60 cms</i>  L1 x p.125,2 x H.72,8	L1							066	NOCE PAVIA	ARGENTO	pavia walnut	silver	
	L.240	L.120	153 060 (*)	89	0,476	11	€ 810,00	090	'WENGE'	ARGENTO	wengè	silver	
	L.280	L.140	153 061 (*)	97	0,509	11	€ 858,00	400	BIANCO BR.	BIANCO	br. white	white	
	L.320	L.160	153 062 (*)	109	0,539	11	€ 910,00	403	ROVERE	BIANCO	oak	white	
	L.360	L.180	153 063 (*)	121	0,559	11	€ 962,00	404	ROVERE GREY	BIANCO	grey oak	white	
	PER KIT WIRE-MANAGER GAMBA CENTRALE, VEDI ART. 738 A PAG.35 <i>for wire-manager kit central leg, please see art.738 to page 35</i>								420	ACERO TAKI	BIANCO	taki maple	white
								444	STONE GREY	BIANCO	stone grey	white	
								490	'WENGE'	BIANCO	wengè	white	
								503	ROVERE	ANTRACITE	oak	anthracite	
								504	ROVERE GREY	ANTRACITE	grey oak	anthracite	
BENCH PROF. CM 60+60 <i>bench deep 60+60 cms</i>  L1 x p.125,2 x H.72,8	L1							521	ACERO TAKI	ANTRACITE	taki maple	anthracite	
	L.360	L.120	153 070 (*)	128	0,691	16	€ 1.140,00	541	BIANCO BR.	ANTRACITE	br. white	anthracite	
	L.420	L.140	153 071 (*)	140	0,741	16	€ 1.212,00	544	STONE GREY	ANTRACITE	stone grey	anthracite	
	L.480	L.160	153 072 (*)	158	0,786	16	€ 1.290,00	566	NOCE PAVIA	ANTRACITE	pavia walnut	anthracite	
	L.540	L.180	153 073 (*)	176	0,816	16	€ 1.368,00	591	'WENGE'	ANTRACITE	wengè	anthracite	
	PER KIT WIRE-MANAGER GAMBA CENTRALE, VEDI ART. 738 A PAG.35 <i>for wire-manager kit central leg, please see art.738 to page 35</i>								803	ROVERE	STONE GREY	oak	stone grey
								804	ROVERE GREY	STONE GREY	grey oak	stone grey	
								820	ACERO TAKI	STONE GREY	taki maple	stone grey	
								840	BIANCO BR.	STONE GREY	br. white	stone grey	
								844	STONE GREY	STONE GREY	stone grey	stone grey	
							866	NOCE PAVIA	STONE GREY	pavia walnut	stone grey		
							890	'WENGE'	STONE GREY	wengè	stone grey		
<b>BENCH PROF.80+80 (PIANI SP. 18mm)</b> <i>bench deep 80+80 cms (tops thick. 18mm)</i>													
BENCH PROF. CM 80+80 <i>bench deep 80+80 cms</i>  L. x p.165,2 x H.72,8		L.120	153 090 (*)	60	0,323	6	€ 550,00						
		L.140	153 091 (*)	62	0,343	6	€ 576,00						
		L.160	153 092 (*)	68	0,361	6	€ 602,00						
		L.180	153 093 (*)	74	0,374	6	€ 636,00						
BENCH PROF. CM 80+80 <i>bench deep 80+80 cms</i>  L1 x p.165,2 x H.72,8	L1												
	L.240	L.120	153 140 (*)	109	0,599	11	€ 916,00						
	L.280	L.140	153 141 (*)	113	0,639	11	€ 968,00						
	L.320	L.160	153 142 (*)	125	0,675	11	€ 1.020,00						
	L.360	L.180	153 143 (*)	137	0,701	11	€ 1.088,00						
	PER KIT WIRE-MANAGER GAMBA CENTRALE, VEDI ART. 739 A PAG.35 <i>for wire-manager kit central leg, please see art.739 to page 35</i>												
BENCH PROF. CM 80+80 <i>bench deep 80+80 cms</i>  L1 x p.165,2 x H.72,8	L1												
	L.360	L.120	153 150 (*)	158	0,875	16	€ 1.282,00						
	L.420	L.140	153 151 (*)	164	0,935	16	€ 1.360,00						
	L.480	L.160	153 152 (*)	182	0,989	16	€ 1.438,00						
	L.540	L.180	153 153 (*)	200	1,029	16	€ 1.540,00						
	PER KIT WIRE-MANAGER GAMBA CENTRALE, VEDI ART. 739 A PAG.35 <i>for wire-manager kit central leg, please see art.739 to page 35</i>												
SCRIVANIA TERMINALE PER BENCH PROF. CM 80+80 <i>terminal desk for bench deep 80+80 cms</i>  L. 165,2 x p.80 x H.72,8		L.165,2	153 169 (*)	36	0,186	4	€ 372,00						

**BENCH PROF.60+60 CON PIANI SCORREVOLI (PIANI SP. 18mm)**

*bench deep 60+60 cms with sliding worktops (tops thick. 18mm)*

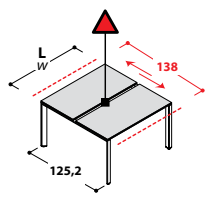
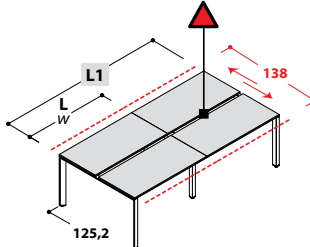
DESCRIZIONE <i>description</i>	L1	L w	CODICE <i>code</i>	KG	M <sup>3</sup>	COLLI 	PREZZO <i>price</i>	(*) CODICE FINITURA <i>(*) finish code</i>				
								(*)	PIANO	STRUTTURA	top structure	
BENCH PROF. CM 60+60 <b>CON PIANI SCORREVOLI</b> <i>bench deep 60+60 cms with sliding worktops</i> 		L120	153 760 (*)	54	0,267	8	€ 590,00	003	ROVERE	ARGENTO	oak	silver
		L140	153 761 (*)	58	0,283	8	€ 614,00	004	ROVERE GREY	ARGENTO	grey oak	silver
		L160	153 762 (*)	64	0,298	8	€ 640,00	020	ACERO TAKI	ARGENTO	taki maple	silver
		L180	153 763 (*)	70	0,308	8	€ 666,00	040	BIANCO BR.	ARGENTO	br. white	silver
								044	STONE GREY	ARGENTO	stone grey	silver
BENCH PROF. CM 60+60 <b>CON PIANI SCORREVOLI</b> <i>bench deep 60+60 cms with sliding worktops</i> 								066	NOCE PAVIA	ARGENTO	pavia walnut	silver
								090	'WENGÉ'	ARGENTO	wengé	silver
								400	BIANCO BR.	BIANCO	br. white	white
								403	ROVERE	BIANCO	oak	white
								404	ROVERE GREY	BIANCO	grey oak	white
								420	ACERO TAKI	BIANCO	taki maple	white
								444	STONE GREY	BIANCO	stone grey	white
								466	NOCE PAVIA	BIANCO	pavia walnut	white
								490	'WENGÉ'	BIANCO	wengé	white
								503	ROVERE	ANTRACITE	oak	anthracite
								504	ROVERE GREY	ANTRACITE	grey oak	anthracite
								521	ACERO TAKI	ANTRACITE	taki maple	anthracite
								541	BIANCO BR.	ANTRACITE	br. white	anthracite
								544	STONE GREY	ANTRACITE	stone grey	anthracite
								566	NOCE PAVIA	ANTRACITE	pavia walnut	anthracite
								591	'WENGÉ'	ANTRACITE	wengé	anthracite
								803	ROVERE	STONE GREY	oak	stone grey
								804	ROVERE GREY	STONE GREY	grey oak	stone grey
								820	ACERO TAKI	STONE GREY	taki maple	stone grey
								840	BIANCO BR.	STONE GREY	br. white	stone grey
							844	STONE GREY	STONE GREY	stone grey	stone grey	
							866	NOCE PAVIA	STONE GREY	pavia walnut	stone grey	
							890	'WENGÉ'	STONE GREY	wengé	stone grey	

L. x p.125,2-138 x H.72,8

L1 x p.125,2-138 x H.72,8

**PER KIT WIRE-MANAGER GAMBA CENTRALE, VEDI ART. 738 A PAG.35**  
*for wire-manager kit central leg, please see art.738 to page 35*

**BENCH PROF.80+80 CON PIANI SCORREVOLI (PIANI SP. 18mm)**

*bench deep 80+80 cms with sliding worktops (tops thick. 18mm)*

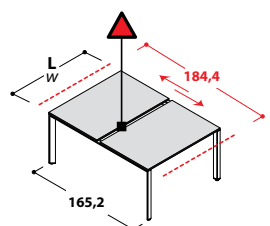
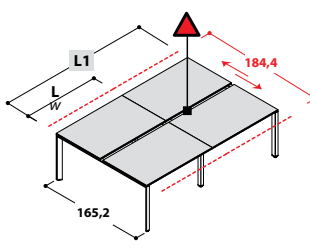
DESCRIZIONE <i>description</i>	L1	L w	CODICE <i>code</i>	KG	M <sup>3</sup>	COLLI 	PREZZO <i>price</i>	(*) CODICE FINITURA <i>(*) finish code</i>				
								(*)	PIANO	STRUTTURA	top structure	
BENCH PROF. CM 80+80 <b>CON PIANI SCORREVOLI</b> <i>bench deep 80+80 cms with sliding worktops</i> 		L120	153 774 (*)	64	0,334	8	€ 686,00	003	ROVERE	ARGENTO	oak	silver
		L140	153 775 (*)	66	0,354	8	€ 712,00	004	ROVERE GREY	ARGENTO	grey oak	silver
		L160	153 776 (*)	72	0,372	8	€ 738,00	020	ACERO TAKI	ARGENTO	taki maple	silver
		L180	153 777 (*)	78	0,385	8	€ 772,00	040	BIANCO BR.	ARGENTO	br. white	silver
								044	STONE GREY	ARGENTO	stone grey	silver
BENCH PROF. CM 80+80 <b>CON PIANI SCORREVOLI</b> <i>bench deep 80+80 cms with sliding worktops</i> 								066	NOCE PAVIA	ARGENTO	pavia walnut	silver
								090	'WENGÉ'	ARGENTO	wengé	silver
								400	BIANCO BR.	BIANCO	br. white	white
								403	ROVERE	BIANCO	oak	white
								404	ROVERE GREY	BIANCO	grey oak	white
								420	ACERO TAKI	BIANCO	taki maple	white
								444	STONE GREY	BIANCO	stone grey	white
								466	NOCE PAVIA	BIANCO	pavia walnut	white
								490	'WENGÉ'	BIANCO	wengé	white
								503	ROVERE	ANTRACITE	oak	anthracite
								504	ROVERE GREY	ANTRACITE	grey oak	anthracite
								521	ACERO TAKI	ANTRACITE	taki maple	anthracite
								541	BIANCO BR.	ANTRACITE	br. white	anthracite
								544	STONE GREY	ANTRACITE	stone grey	anthracite
								566	NOCE PAVIA	ANTRACITE	pavia walnut	anthracite
								591	'WENGÉ'	ANTRACITE	wengé	anthracite
								803	ROVERE	STONE GREY	oak	stone grey
								804	ROVERE GREY	STONE GREY	grey oak	stone grey
								820	ACERO TAKI	STONE GREY	taki maple	stone grey
								840	BIANCO BR.	STONE GREY	br. white	stone grey
							844	STONE GREY	STONE GREY	stone grey	stone grey	
							866	NOCE PAVIA	STONE GREY	pavia walnut	stone grey	
							890	'WENGÉ'	STONE GREY	wengé	stone grey	

L. x p.165,2-184,4 x H.72,8

L1 x p.165,2-184,4 x H.72,8

**PER KIT WIRE-MANAGER GAMBA CENTRALE, VEDI ART. 739 A PAG.35**  
*for wire-manager kit central leg, please see art.739 to page 35*

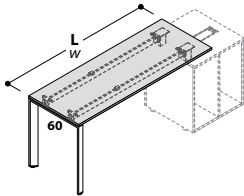
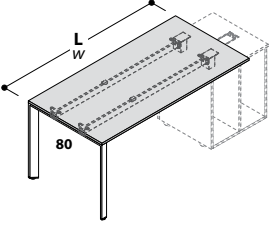

**SCRIVANIE CON GAMBA A PONTE (PIANI SP. 18mm)***desks with bridge leg (tops thick. 18mm)*

DESCRIZIONE <i>description</i>	L w	CODICE <i>code</i>	KG	M <sup>3</sup>	COLLI	PREZZO <i>price</i>	(*) CODICE FINITURA <i>(*) finish code</i>
SCRIVANIE PROF. CM 60 PER PORTA-CPU <b>(CON TRAVI E STAFFE IN DOTAZIONE)</b> <i>desks deep 60 cms for CPU-holder (with beams and stirrups)</i>   L. x p.60 x H.72,8	L.120	<b>153 190 (*)</b>	22	0,087	4	<b>€ 229,00</b>	
	L.140	<b>153 191 (*)</b>	24	0,097	4	<b>€ 242,00</b>	
	L.160	<b>153 192 (*)</b>	27	0,105	4	<b>€ 254,00</b>	
	L.180	<b>153 193 (*)</b>	30	0,113	4	<b>€ 266,00</b>	
SCRIVANIE PROF. CM 80 PER PORTA-CPU <b>(CON TRAVI E STAFFE IN DOTAZIONE)</b> <i>desks deep 80 cms for CPU-holder (with beams and stirrups)</i>   L. x p.80 x H.72,8	L.120	<b>153 195 (*)</b>	26	0,109	4	<b>€ 250,00</b>	
	L.140	<b>153 196 (*)</b>	27	0,121	4	<b>€ 264,00</b>	
	L.160	<b>153 197 (*)</b>	30	0,131	4	<b>€ 276,00</b>	
	L.180	<b>153 198 (*)</b>	33	0,140	4	<b>€ 292,00</b>	

(*)	PIANO	STRUTTURA	top	structure
003	ROVERE	ARGENTO	oak	silver
004	ROVERE GREY	ARGENTO	grey oak	silver
020	ACERO TAKI	ARGENTO	taki maple	silver
040	BIANCO BR.	ARGENTO	br. white	silver
044	STONE GREY	ARGENTO	stone grey	silver
066	NOCE PAVIA	ARGENTO	pavia walnut	silver
090	'WENGÉ'	ARGENTO	wengé	silver
400	BIANCO BR.	BIANCO	br. white	white
403	ROVERE	BIANCO	oak	white
404	ROVERE GREY	BIANCO	grey oak	white
420	ACERO TAKI	BIANCO	taki maple	white
444	STONE GREY	BIANCO	stone grey	white
466	NOCE PAVIA	BIANCO	pavia walnut	white
490	'WENGÉ'	BIANCO	wengé	white
503	ROVERE	ANTRACITE	oak	anthracite
504	ROVERE GREY	ANTRACITE	grey oak	anthracite
521	ACERO TAKI	ANTRACITE	taki maple	anthracite
541	BIANCO BR.	ANTRACITE	br. white	anthracite
544	STONE GREY	ANTRACITE	stone grey	anthracite
566	NOCE PAVIA	ANTRACITE	pavia walnut	anthracite
591	'WENGÉ'	ANTRACITE	wengé	anthracite
803	ROVERE	STONE GREY	oak	stone grey
804	ROVERE GREY	STONE GREY	grey oak	stone grey
820	ACERO TAKI	STONE GREY	taki maple	stone grey
840	BIANCO BR.	STONE GREY	br. white	stone grey
844	STONE GREY	STONE GREY	stone grey	stone grey
866	NOCE PAVIA	STONE GREY	pavia walnut	stone grey
890	'WENGÉ'	STONE GREY	wengé	stone grey

**BENCH CON GAMBA A PONTE (PIANI SP. 18mm)***bench with bridge leg (tops thick. 18mm)*

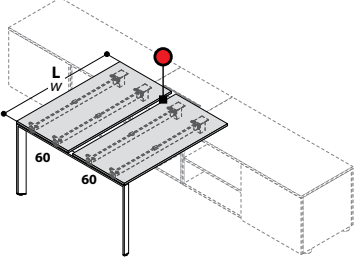
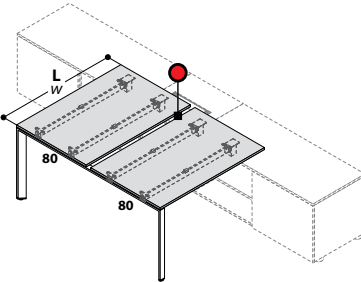
DESCRIZIONE <i>description</i>	L	CODICE <i>code</i>	KG	M <sup>3</sup>	COLLI	PREZZO <i>price</i>	(*) CODICE FINITURA <i>(*) finish code</i>
BENCH PROF. CM 60+60 PER PORTA-CPU <b>(CON TRAVI E STAFFE IN DOTAZIONE)</b> <i>bench 60+60 cms for CPU-holder (with beams and stirrups)</i>   L. x p.125,2 x H.72,8	L.140	<b>153 212 (*)</b>	45	0,197	7	<b>€ 420,00</b>	
	L.160	<b>153 213 (*)</b>	51	0,213	7	<b>€ 444,00</b>	
	L.180	<b>153 214 (*)</b>	57	0,228	7	<b>€ 468,00</b>	
BENCH PROF. CM 80+80 PER PORTA-CPU <b>(CON TRAVI E STAFFE IN DOTAZIONE)</b> <i>bench deep 80+80 cms for CPU-holder (with beams and stirrups)</i>   L. x p.165,2 x H.72,8	L.140	<b>153 216 (*)</b>	51	0,241	7	<b>€ 468,00</b>	
	L.160	<b>153 217 (*)</b>	57	0,261	7	<b>€ 492,00</b>	
	L.180	<b>153 218 (*)</b>	63	0,279	7	<b>€ 524,00</b>	

● **PER COPERTURE CENTRALI , PANNELLI FRONTALI e BARRE ATTREZZABILI  
VEDI DA PAG. 28 A 32  
for central covers, front panels and toolbars, please see pages from 28 to 32**

● **PER COPERTURE CENTRALI , PANNELLI FRONTALI e BARRE ATTREZZABILI  
VEDI DA PAG. 28 A 32  
for central covers, front panels and toolbars, please see pages from 28 to 32**

(*)	PIANO	STRUTTURA	top	structure
003	ROVERE	ARGENTO	oak	silver
004	ROVERE GREY	ARGENTO	grey oak	silver
020	ACERO TAKI	ARGENTO	taki maple	silver
040	BIANCO BR.	ARGENTO	br. white	silver
044	STONE GREY	ARGENTO	stone grey	silver
066	NOCE PAVIA	ARGENTO	pavia walnut	silver
090	'WENGÉ'	ARGENTO	wengé	silver
400	BIANCO BR.	BIANCO	br. white	white
403	ROVERE	BIANCO	oak	white
404	ROVERE GREY	BIANCO	grey oak	white
420	ACERO TAKI	BIANCO	taki maple	white
444	STONE GREY	BIANCO	stone grey	white
466	NOCE PAVIA	BIANCO	pavia walnut	white
490	'WENGÉ'	BIANCO	wengé	white
503	ROVERE	ANTRACITE	oak	anthracite
504	ROVERE GREY	ANTRACITE	grey oak	anthracite
521	ACERO TAKI	ANTRACITE	taki maple	anthracite
541	BIANCO BR.	ANTRACITE	br. white	anthracite
544	STONE GREY	ANTRACITE	stone grey	anthracite
566	NOCE PAVIA	ANTRACITE	pavia walnut	anthracite
591	'WENGÉ'	ANTRACITE	wengé	anthracite
803	ROVERE	STONE GREY	oak	stone grey
804	ROVERE GREY	STONE GREY	grey oak	stone grey
820	ACERO TAKI	STONE GREY	taki maple	stone grey
840	BIANCO BR.	STONE GREY	br. white	stone grey
844	STONE GREY	STONE GREY	stone grey	stone grey
866	NOCE PAVIA	STONE GREY	pavia walnut	stone grey
890	'WENGÉ'	STONE GREY	wengé	stone grey





## ESEMPI DI UTILIZZO SCRIVANIE CON GAMBE A PONTE PER PORTA-CPU (pag.53)

desks with bridge legs for CPU-holder fact-sheet (pages 53)

**SCRIVANIE CON PIANI PROF. CM 60-80**  
desks with worktops deep 23¾"-31½"

ART.190-191-192-193  
ART.195-196-197-198

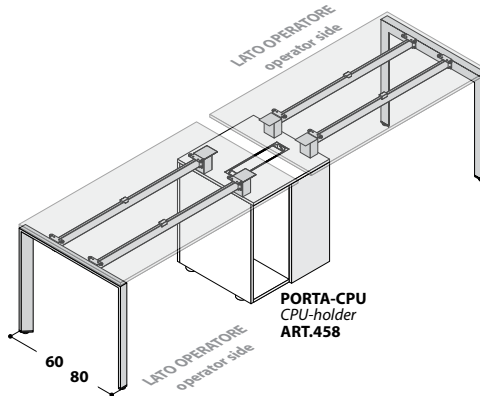
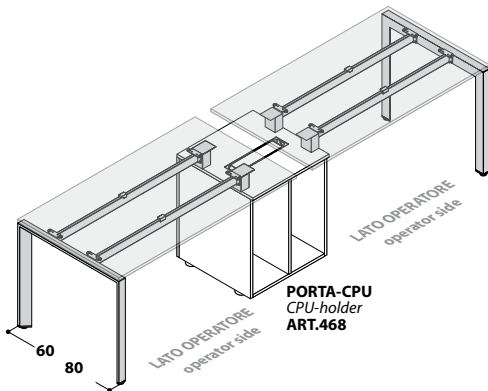
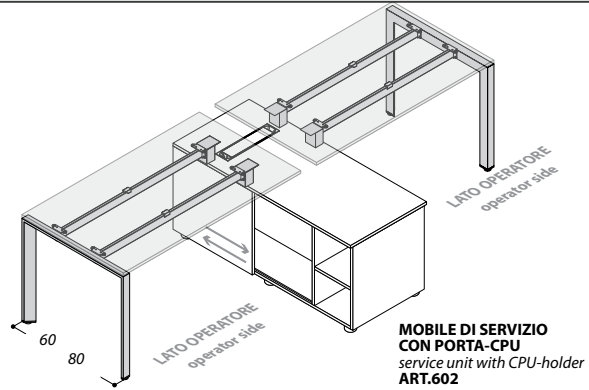
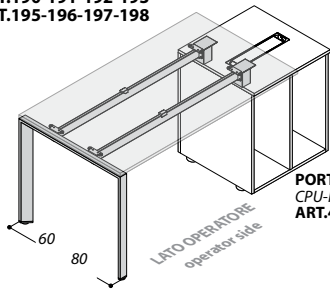

**BENCH CON PIANI PROF. CM 60-80**  
BENCH with worktops deep 23¾"-31½"

ART.212-213-214  
ART.216-217-218

**COMPLETARE CON STAFFA**  
complete with stirrup  
**ART.206**

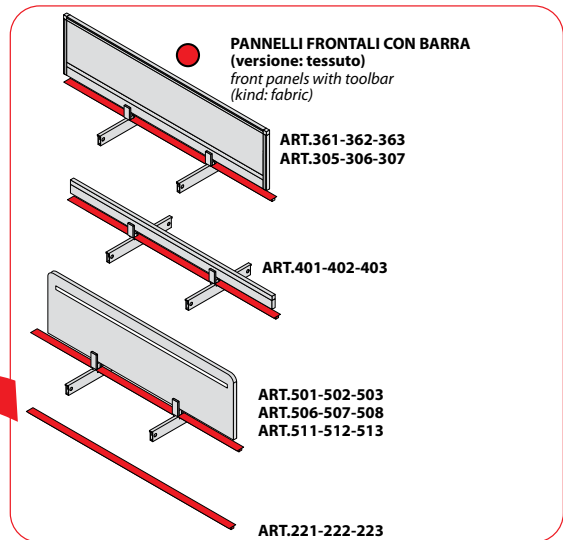
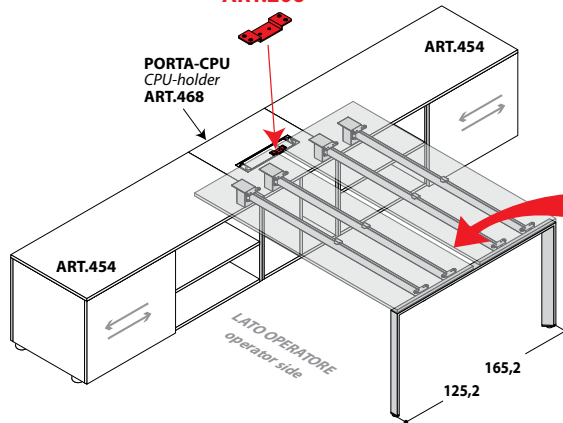

**COMPLETARE CON STAFFA**  
complete with stirrup  
**ART.206**

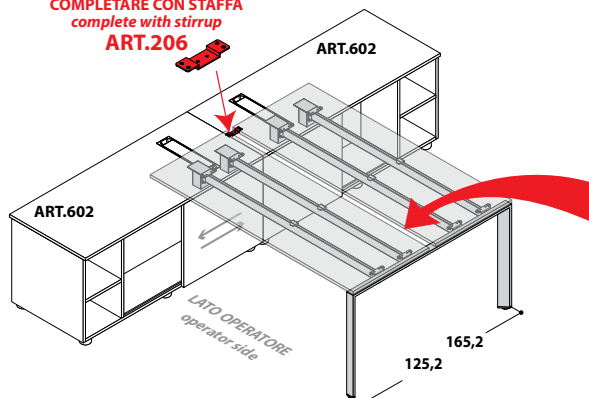

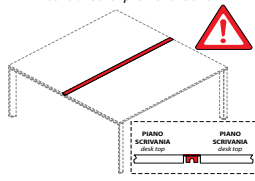
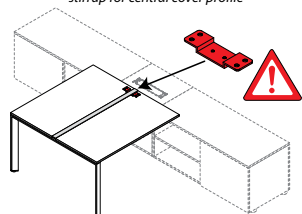
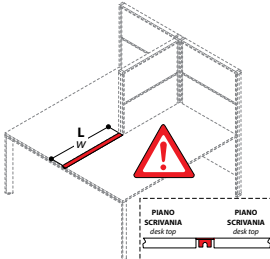
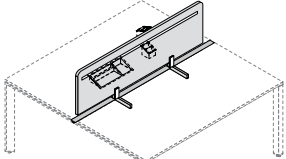
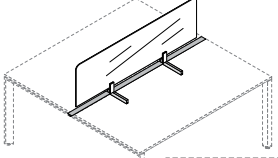
<b>COMPLEMENTI PER BENCH</b> <i>complements for bench</i>		<b>QUESTI ARTICOLI NON SONO UTILIZZABILI SU SCRIVANIE CON PIANI SCORREVOLI!</b> <i>don't use these items on desks with sliding tops!</i>								
<b>DESCRIZIONE</b> <i>description</i>	<b>L</b> <i>w</i>	<b>CODICE</b> <i>code</i>	<b>KG</b> 	<b>M<sup>3</sup></b> 	<b>COLLI</b> 	<b>PREZZO</b> <i>price</i>	<b>(*) CODICE FINITURA</b> <i>(*) finish code</i>			
<b>COPERTURA CENTRALE PER BENCH</b> <i>central cover profile for bench</i>  L. x p.5,2 x H.1,6	L120	153 <b>220</b> (*)	1	0,006	1	€ 54,00				
	L140	153 <b>221</b> (*)	1	0,008	1	€ 57,00	(*)			
	L160	153 <b>222</b> (*)	1	0,008	1	€ 59,00	000	ARGENTO	silver	
	L180	153 <b>223</b> (*)	1,5	0,012	1	€ 61,00				
<b>STAFFA PER COPERTURA CENTRALE</b> <i>stirrup for central cover profile</i> 		153 <b>206</b> (*)	1,5	0,001	1	€ 15,00	(*)			
							000	ARGENTO	silver	
							400	BIANCO	white	
							551	ANTRACITE	anthracite	
							844	STONE GREY	stone grey	
<b>COPERTURA CENTRALE PER BENCH CON PARETINE</b> <i>central cover profile for bench with partition panels</i>  L. x p.5,2 x H.1,6	L60	153 <b>201</b> (*)	1,5	0,005	1	€ 35,00				
	L70	153 <b>202</b> (*)	1,5	0,007	1	€ 37,00				
	L80	153 <b>203</b> (*)	1,5	0,004	1	€ 39,00	(*)			
	L90	153 <b>204</b> (*)	1,5	0,004	1	€ 42,00	000	ARGENTO	silver	
	L100	153 <b>234</b> (*)	1,5	0,007	1	€ 45,00				
	L120	153 <b>239</b> (*)	1,5	0,006	1	€ 48,00				
<b>PANNELLI FRONTALI E COPERTURA CENTRALE PER BENCH</b> <i>front panels and central cover profile for bench</i>  L. x p.2,5 x H.35,5		<b>MELAMINICO</b> <i>melamine</i>					(*)	<b>MELAMINICO</b> <i>melamine</i>		
	L120	153 <b>500</b> (*)	9,5	0,031	3	€ 105,00	000	ARGENTO GOLF	golf silver	
	L140	153 <b>501</b> (*)	10,5	0,037	3	€ 116,00	166	NOCE PAVIA	pavia walnut	
	L160	153 <b>502</b> (*)	11,5	0,037	3	€ 127,00	200	ACERO TAKI	taki maple	
	L180	153 <b>503</b> (*)	12,5	0,044	3	€ 140,00	400	BIANCO BR.	br. white	
							551	ANTRACITE	anthracite	
							704	ROVERE GREY	grey oak	
							733	ROVERE	oak	
							844	STONE GREY	stone grey	
							900	WENGE'	wenge	
		<b>TESSUTO</b> <i>fabric</i>					(*)	<b>TESSUTO POLIESTERE</b> <i>fire-retardant stretch polyester fabric</i>		
L120	153 <b>505</b> (*)	9,5	0,031	3	€ 210,00	320	AZZURRO SKY	sky blue		
L140	153 <b>506</b> (*)	10,5	0,037	3	€ 222,00	321	GIALLO FRESIA	freesia yellow		
L160	153 <b>507</b> (*)	11,5	0,037	3	€ 248,00	322	AMARANTO	amaranth		
L180	153 <b>508</b> (*)	12,5	0,044	3	€ 269,00	323	VERDE BOSCO	wood green		
						327	GRIGIO	grey		
						328	TORTORA	grey beige		
						330	MATTONE	brick red		
						331	ARANCIO	orange		
						332	ROSSO	red		
						333	VERDE ACIDO	acid green		
						334	BLU	blue		
<b>PANNELLI FRONTALI IN METACRILATO E COPERTURA CENTRALE PER BENCH</b> <i>methacrylate front panels and central cover profile for bench</i>  L. x p.0,5 x H.35,5		<b>METACRILATO</b> <i>methacrylate</i>					(*)			
	L120	153 <b>510</b> (*)	5,5	0,011	3	€ 155,00	999	METACRILATO BIANCO	white methacrylate	
	L140	153 <b>511</b> (*)	6	0,013	3	€ 168,00				
	L160	153 <b>512</b> (*)	6,5	0,013	3	€ 183,00				
	L180	153 <b>513</b> (*)	7,5	0,018	3	€ 222,00				

**COMPLEMENTI PER BENCH**  
*complements for bench*

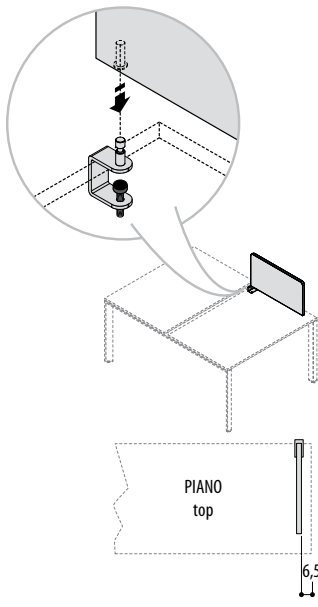
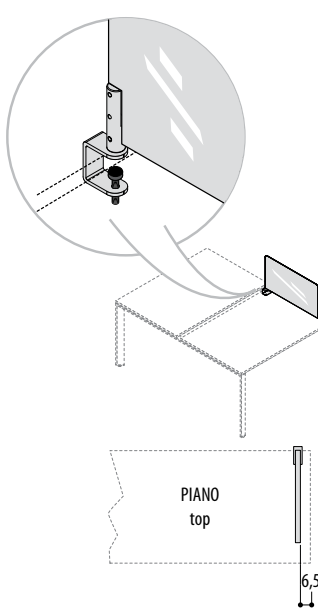
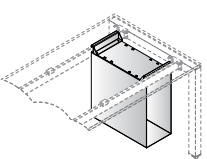

DESCRIZIONE <i>description</i>	L w	CODICE <i>code</i>	KG	M <sup>2</sup>	COLLI	PREZZO <i>price</i>	(*) CODICE FINITURA <i>(*) finish code</i>																																				
PANNELLO LATERALE <i>side panel</i>   L. x p.2,5 x H.35,5	<b>MELAMINICO <i>melamine</i></b>						<table border="1"> <thead> <tr> <th>(*)</th> <th>MELAMINICO <i>melamine</i></th> <th></th> </tr> </thead> <tbody> <tr> <td>000</td> <td>ARGENTO GOLF</td> <td><i>golf silver</i></td> </tr> <tr> <td>166</td> <td>NOCE PAVIA</td> <td><i>pavia walnut</i></td> </tr> <tr> <td>200</td> <td>ACERO TAKI</td> <td><i>taki maple</i></td> </tr> <tr> <td>400</td> <td>BIANCO BR.</td> <td><i>br. white</i></td> </tr> <tr> <td>551</td> <td>ANTRACITE</td> <td><i>anthracite</i></td> </tr> <tr> <td>704</td> <td>ROVERE GREY</td> <td><i>grey oak</i></td> </tr> <tr> <td>733</td> <td>ROVERE</td> <td><i>oak</i></td> </tr> <tr> <td>844</td> <td>STONE GREY</td> <td><i>stone grey</i></td> </tr> <tr> <td>900</td> <td>WENGE'</td> <td><i>wenge</i></td> </tr> </tbody> </table>	(*)	MELAMINICO <i>melamine</i>		000	ARGENTO GOLF	<i>golf silver</i>	166	NOCE PAVIA	<i>pavia walnut</i>	200	ACERO TAKI	<i>taki maple</i>	400	BIANCO BR.	<i>br. white</i>	551	ANTRACITE	<i>anthracite</i>	704	ROVERE GREY	<i>grey oak</i>	733	ROVERE	<i>oak</i>	844	STONE GREY	<i>stone grey</i>	900	WENGE'	<i>wenge</i>						
	(*)	MELAMINICO <i>melamine</i>																																									
000	ARGENTO GOLF	<i>golf silver</i>																																									
166	NOCE PAVIA	<i>pavia walnut</i>																																									
200	ACERO TAKI	<i>taki maple</i>																																									
400	BIANCO BR.	<i>br. white</i>																																									
551	ANTRACITE	<i>anthracite</i>																																									
704	ROVERE GREY	<i>grey oak</i>																																									
733	ROVERE	<i>oak</i>																																									
844	STONE GREY	<i>stone grey</i>																																									
900	WENGE'	<i>wenge</i>																																									
	L.50	153 <b>245 (*)</b>	5	0,011	2	€ 48,00	400																																				
	L.70	153 <b>246 (*)</b>	6	0,018	2	€ 54,00	551																																				
	L.80	153 <b>247 (*)</b>	7	0,020	2	€ 59,00	704																																				
							733																																				
							844																																				
							900																																				
PANNELLO LATERALE IN METACRILATO <i>methacrylate side panel</i>   L. x p.0,5 x H.35,5	<b>METACRILATO <i>methacrylate</i></b>						<table border="1"> <thead> <tr> <th>(*)</th> <th>TESSUTO POLIESTERE STRETCH IGNIFUGO <i>fire-retardant stretch polyester fabric</i></th> <th></th> </tr> </thead> <tbody> <tr> <td>320</td> <td>AZZURRO SKY</td> <td><i>sky blue</i></td> </tr> <tr> <td>321</td> <td>GIALLO FRESIA</td> <td><i>freesia yellow</i></td> </tr> <tr> <td>322</td> <td>AMARANTO</td> <td><i>amaranth</i></td> </tr> <tr> <td>323</td> <td>VERDE BOSCO</td> <td><i>wood green</i></td> </tr> <tr> <td>327</td> <td>GRIGIO</td> <td><i>grey</i></td> </tr> <tr> <td>328</td> <td>TORTORA</td> <td><i>grey beige</i></td> </tr> <tr> <td>330</td> <td>MATTONI</td> <td><i>brick red</i></td> </tr> <tr> <td>331</td> <td>ARANCIO</td> <td><i>orange</i></td> </tr> <tr> <td>332</td> <td>ROSSO</td> <td><i>red</i></td> </tr> <tr> <td>333</td> <td>VERDE ACIDO</td> <td><i>acid green</i></td> </tr> <tr> <td>334</td> <td>BLU</td> <td><i>blue</i></td> </tr> </tbody> </table>	(*)	TESSUTO POLIESTERE STRETCH IGNIFUGO <i>fire-retardant stretch polyester fabric</i>		320	AZZURRO SKY	<i>sky blue</i>	321	GIALLO FRESIA	<i>freesia yellow</i>	322	AMARANTO	<i>amaranth</i>	323	VERDE BOSCO	<i>wood green</i>	327	GRIGIO	<i>grey</i>	328	TORTORA	<i>grey beige</i>	330	MATTONI	<i>brick red</i>	331	ARANCIO	<i>orange</i>	332	ROSSO	<i>red</i>	333	VERDE ACIDO	<i>acid green</i>	334	BLU	<i>blue</i>
	(*)	TESSUTO POLIESTERE STRETCH IGNIFUGO <i>fire-retardant stretch polyester fabric</i>																																									
320	AZZURRO SKY	<i>sky blue</i>																																									
321	GIALLO FRESIA	<i>freesia yellow</i>																																									
322	AMARANTO	<i>amaranth</i>																																									
323	VERDE BOSCO	<i>wood green</i>																																									
327	GRIGIO	<i>grey</i>																																									
328	TORTORA	<i>grey beige</i>																																									
330	MATTONI	<i>brick red</i>																																									
331	ARANCIO	<i>orange</i>																																									
332	ROSSO	<i>red</i>																																									
333	VERDE ACIDO	<i>acid green</i>																																									
334	BLU	<i>blue</i>																																									
	L.50	153 <b>251 (*)</b>	2	0,002	2	€ 105,00	(*)																																				
	L.70	153 <b>252 (*)</b>	2,5	0,003	2	€ 118,00	999																																				
	L.80	153 <b>253 (*)</b>	3	0,003	2	€ 128,00	METACRILATO BIANCO <i>white methacrylate</i>																																				
PORTA-CPU SOSPESO <i>suspended CPU-holder</i>   L.22 x p.50 x H.50		153 <b>264 (*)</b>	5	0,006	1	€ 124,00	(*)																																				
		<b>NON UTILIZZABILE SU PIANI PROF. CM 90 <i>do not usable under desktops deep 90 cms</i></b>						<table border="1"> <tbody> <tr> <td>000</td> <td>ARGENTO</td> <td><i>silver</i></td> </tr> <tr> <td>400</td> <td>BIANCO</td> <td><i>white</i></td> </tr> <tr> <td>551</td> <td>ANTRACITE</td> <td><i>anthracite</i></td> </tr> <tr> <td>844</td> <td>STONE GREY</td> <td><i>stone grey</i></td> </tr> </tbody> </table>	000	ARGENTO	<i>silver</i>	400	BIANCO	<i>white</i>	551	ANTRACITE	<i>anthracite</i>	844	STONE GREY	<i>stone grey</i>																							
000	ARGENTO	<i>silver</i>																																									
400	BIANCO	<i>white</i>																																									
551	ANTRACITE	<i>anthracite</i>																																									
844	STONE GREY	<i>stone grey</i>																																									

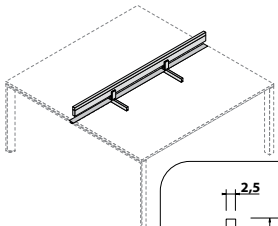
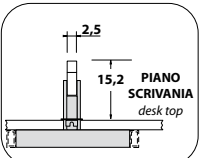
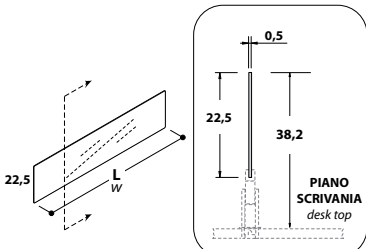
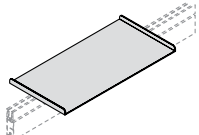
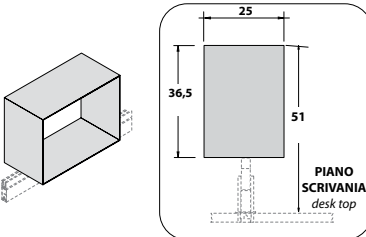
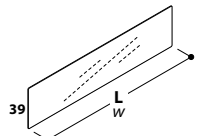
**BARRE ATTREZZABILI FRONTALI E COMPLEMENTI PER BENCH***front toolbars and complements for bench*

DESCRIZIONE <i>description</i>	L <i>w</i>	CODICE <i>code</i>	KG	M <sup>3</sup>	COLLI	PREZZO <i>price</i>	(*) CODICE FINITURA <i>(*) finish code</i>	
<b>BARRA ATTREZZABILE FRONTALE E COPERTURA CENTRALE PER BENCH</b> <i>front toolbar and central cover profile for bench</i>   L. x p.2,5 x H.15,2	L.120	153 400 (*)	4,5	0,020	3	€ 130,00		
	L.140	153 401 (*)	4,5	0,022	3	€ 147,00	(*)	
	L.160	153 402 (*)	5,5	0,022	3	€ 160,00	000 ALLUMINIO <i>aluminium</i>	
	L.180	153 403 (*)	5,5	0,026	3	€ 175,00		
<b>SCHERMI FRONTALI IN METACRILATO BIANCO</b> H.38,2 <i>white methacrylate front screens</i>  L. x p.0,5 x H.22,5	<b>H.38,2 (dal piano scrivania)</b> <i>h.15" (from desktop)</i>							
	L.60	153 407 (*)	1,5	0,001	1	€ 40,00		
	L.80	153 408 (*)	2	0,002	1	€ 53,00		
	L.100	153 409 (*)	2,5	0,002	1	€ 72,00		
	L.120	153 410 (*)	3	0,002	1	€ 85,00	(*) SCHERMO FRONTALE <i>front screen</i>	
	L.140	153 411 (*)	3	0,003	1	€ 99,00	999 METACRILATO BIANCO <i>white methacrylate</i>	
	L.160	153 412 (*)	3	0,003	1	€ 114,00		
	L.180	153 413 (*)	4	0,004	1	€ 137,00		
	<b>COMPLETARE SEMPRE CON BARRA ATTREZZABILE FRONTALE</b> <i>always complete with front toolbar</i> <b>ART. 400-401-402-403</b>							
<b>MENSOLA CENTRALE</b> <i>central shelf</i>  L.50 x p.25 x H.2	L.50	153 450 (*)	5	0,016	1	€ 46,00		
<b>PORTA-DOX CENTRALE</b> <i>central dox-holder</i>  L.50 x p.25 x H.36,5							(*) ARGENTO <i>silver</i>	
							400 BIANCO <i>white</i>	
							551 ANTRACITE <i>anthracite</i>	
							844 STONE GREY <i>stone grey</i>	
	L.50	153 451 (*)	5	0,076	1	€ 102,00		
<b>SCHERMI FRONTALI IN METACRILATO BIANCO PER BARRE ATTREZZABILI LATERALI A FILO PIANO</b> <i>white methacrylate front screens for lateral desk height toolbars</i>  L. x p.0,5 x H.39	L.60	152 331 (*)	2	0,001	1	€ 60,00		
	L.80	152 332 (*)	2	0,002	1	€ 87,00		
							(*) SCHERMO FRONTALE <i>front screen</i>	
							999 METACRILATO BIANCO <i>white methacrylate</i>	
	<b>COMPLETARE SEMPRE CON BARRA ATTREZZABILE A FILO PIANO</b> <b>VEDI PAGINA SEGUENTE</b> <i>always complete with desk height toolbar, please see next page</i>							

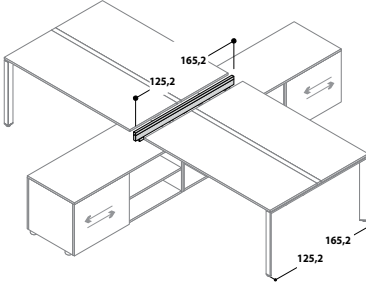
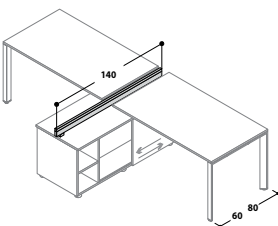
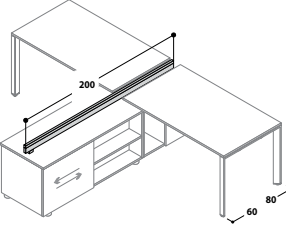
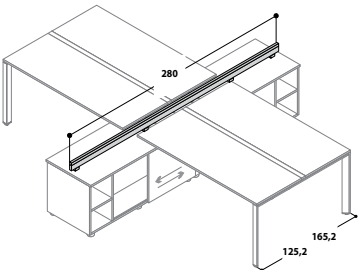
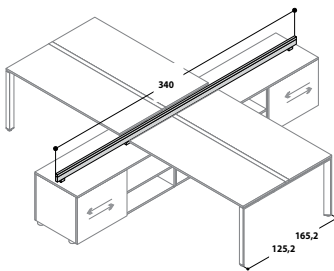

**BARRE ATTREZZABILI LATERALI A FILO PIANO***lateral desk height toolbars*

DESCRIZIONE <i>description</i>	L w	CODICE <i>code</i>	KG 	M <sup>3</sup> 	COLLI 	PREZZO <i>price</i>	(*) CODICE FINITURA <i>(*) finish code</i>
BARRE ATTREZZABILI LATERALI A FILO PIANO <i>lateral desk height toolbars</i>  L. x p.2,5 x H.11,6	(a filo piano scrivania) <i>(desk height)</i>						
	L125,2	153 430 (*)	3	0,018	2	€ 91,00	
	L165,2	153 431 (*)	3	0,018	2	€ 119,00	
BARRA ATTREZZABILE LATERALE A FILO PIANO <i>lateral desk height toolbar</i>  L.140 x p.2,5 x H.11,6	(a filo piano scrivania) <i>(desk height)</i>						
	L140	153 433 (*)	3	0,018	2	€ 102,00	
BARRA ATTREZZABILE LATERALE A FILO PIANO <i>lateral desk height toolbar</i>  L.200 x p.2,5 x H.11,6	(a filo piano scrivania) <i>(desk height)</i>						
	L200	153 434 (*)	5	0,018	2	€ 133,00	
	(*) 000	ALLUMINIO					
BARRA ATTREZZABILE LATERALE A FILO PIANO <i>lateral desk height toolbar</i>  L.280 x p.2,5 x H.11,6	(a filo piano scrivania) <i>(desk height)</i>						
	L280	153 435 (*)	3	0,018	2	€ 191,00	
BARRA ATTREZZABILE LATERALE A FILO PIANO <i>lateral desk height toolbar</i>  L.340 x p.2,5 x H.11,6	(a filo piano scrivania) <i>(desk height)</i>						
	L340	153 436 (*)	3	0,018	2	€ 223,00	

### PANNELLI FRONTALI CON BARRA-ATTEZZABILE PER BENCH (h.38,2 DAL PIANO SCRIVANIA)



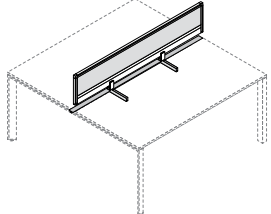
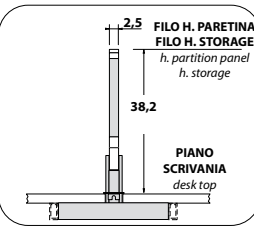

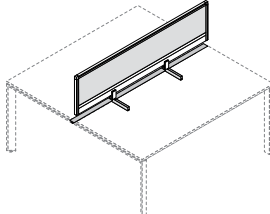
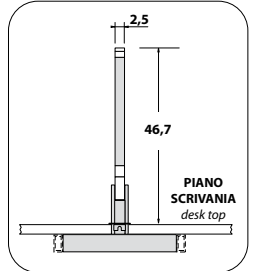

front panels with toolbar for bench (h.38,2 cms from worktop)

DESCRIZIONE description	L w	CODICE code	KG	M <sup>3</sup>	COLLI	PREZZO price	(*) CODICE FINITURA (*) finish code	
PANNELLI FRONTALI CON BARRA ATTEZZABILE E <b>COPERTURA CENTRALE PER BENCH</b> <i>front panels with toolbar and            central cover profile for bench</i>      L. x p.2,5 x H.38,2								
			TESSUTO fabric					
	L.120	153 <b>360</b> (*)	7,5	0,039	3	€ 248,00		
	L.140	153 <b>361</b> (*)	8,5	0,037	3	€ 270,00		
	L.160	153 <b>362</b> (*)	9,5	0,037	3	€ 312,00		
	L.180	153 <b>363</b> (*)	9,5	0,044	3	€ 345,00		
							(*)	
							TESSUTO POLIESTERE STRETCH IGNIFUGO	fire-retardant stretch polyester fabric
							320	AZZURRO SKY sky blue
							321	GIALLO FRESIA freesia yellow
						322	AMARANTO amaranth	
						323	VERDE BOSCO wood green	
						327	GRIGIO grey	
						328	TORTORA grey beige	
						330	MATTONE brick red	
						331	ARANCIO orange	
						332	ROSSO red	
						333	VERDE ACIDO acid green	
						334	BLU blue	

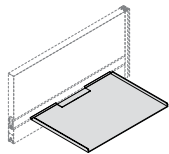
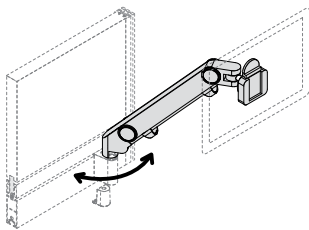
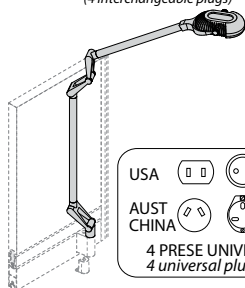

### PANNELLI FRONTALI CON BARRA-ATTEZZABILE PER BENCH (h.46,7 DAL PIANO SCRIVANIA)

front panels with toolbar for bench (h.46,7 cms from worktop)

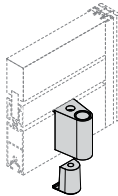
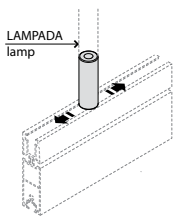
DESCRIZIONE description	L w	CODICE code	KG	M <sup>3</sup>	COLLI	PREZZO price	(*) CODICE FINITURA (*) finish code	
PANNELLI FRONTALI CON BARRA ATTEZZABILE E <b>COPERTURA CENTRALE PER BENCH</b> <i>front panels with toolbar and            central cover profile for bench</i>      L. x p.2,5 x H.46,7								
			TESSUTO fabric					
	L.120	153 <b>304</b> (*)	7,5	0,039	3	€ 263,00		
	L.140	153 <b>305</b> (*)	8,5	0,041	3	€ 281,00		
	L.160	153 <b>306</b> (*)	9,5	0,046	3	€ 314,00		
	L.180	153 <b>307</b> (*)	9,5	0,055	3	€ 358,00		
							(*)	
							TESSUTO POLIESTERE STRETCH IGNIFUGO	fire-retardant stretch polyester fabric
							320	AZZURRO SKY sky blue
							321	GIALLO FRESIA freesia yellow
						322	AMARANTO amaranth	
						323	VERDE BOSCO wood green	
						327	GRIGIO grey	
						328	TORTORA grey beige	
						330	MATTONE brick red	
						331	ARANCIO orange	
						332	ROSSO red	
						333	VERDE ACIDO acid green	
						334	BLU blue	

ACCESSORI PER PANNELLI FRONTALI CON BARRA ATTREZZABILE							
accessories for front panels with toolbar							
DESCRIZIONE description	L w	CODICE code	KG	M <sup>3</sup>	COLLI	PREZZO price	(*) CODICE FINITURA (*) finish code
MENSOLA PORTA-DOCUMENTI file-holder shelf    L.34 x p.25 x H.1,2		153 750 (*)	2	0,014	1	€ 46,00	(*) 000 ARGENTO silver
BRACCIO GIREVOLE PORTA-VIDEO (PORTATA MAX. KG 9- DIMENSIONI DA 15" A 23") rotating video stand arm (max capacity Kg 9- sizes 15"-23")  		153 751 (*)	2	0,002	1	€ 188,00	
	COMPLETARE SEMPRE CON SUPPORTO ART.755 always complete with support art.755						
LAMPADA A LED - 5 Watt (con 4 prese universali intercambiabili) led lamp - 5 Watt (4 interchangeable plugs)   USA  EU  AUST  CHINA  UK  4 PRESE UNIVERSALI 4 universal plugs		153 753 (*)	0,8	0,002	1	€ 387,00	
	COMPLETARE SEMPRE CON SUPPORTO ART.755 OPPURE ART.756 always complete with support art.755 or art.756						
SUPPORTO PER LAMPADE O PER BRACCIO GIREVOLE support for lamps or rotating video stand arm    H.6		153 755 (*)	2	0,001	1	€ 22,00	
SUPPORTO PER LAMPADE support for lamps    Ø 2,2 x H.5		153 756 (*)	2	0,001	1	€ 32,00	

**PIANI SCRIVANIE PER GAMBE A PONTE***desktops for bridge legs*

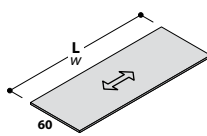

DESCRIZIONE <i>description</i>	L <i>w</i>	CODICE <i>code</i>	KG 	M <sup>3</sup> 	COLLI 	PREZZO <i>price</i>	(*) CODICE FINITURA <i>(*) finish code</i>																										
PIANI SCRIVANIE PROF. CM 60 <i>desktops deep 60 cms</i>    L. x p.60 x H.	PIANO sp. 18mm <i>top thick. 18mm</i>		L120	153 <b>810</b> (*)	11	0,032	1	€ 44,00	<table border="1"> <thead> <tr> <th>(*)</th> <th>PIANO</th> <th><i>top</i></th> </tr> </thead> <tbody> <tr><td>166</td><td>NOCE PAVIA</td><td><i>pavia walnut</i></td></tr> <tr><td>200</td><td>ACERO TAKI</td><td><i>taki maple</i></td></tr> <tr><td>400</td><td>BIANCO BR.</td><td><i>br. white</i></td></tr> <tr><td>704</td><td>ROVERE GREY</td><td><i>grey oak</i></td></tr> <tr><td>733</td><td>ROVERE</td><td><i>oak</i></td></tr> <tr><td>844</td><td>STONE GREY</td><td><i>stone grey</i></td></tr> <tr><td>900</td><td>WENGE'</td><td><i>wenge</i></td></tr> </tbody> </table>	(*)	PIANO	<i>top</i>	166	NOCE PAVIA	<i>pavia walnut</i>	200	ACERO TAKI	<i>taki maple</i>	400	BIANCO BR.	<i>br. white</i>	704	ROVERE GREY	<i>grey oak</i>	733	ROVERE	<i>oak</i>	844	STONE GREY	<i>stone grey</i>	900	WENGE'	<i>wenge</i>
	(*)	PIANO	<i>top</i>																														
	166	NOCE PAVIA	<i>pavia walnut</i>																														
	200	ACERO TAKI	<i>taki maple</i>																														
	400	BIANCO BR.	<i>br. white</i>																														
	704	ROVERE GREY	<i>grey oak</i>																														
	733	ROVERE	<i>oak</i>																														
	844	STONE GREY	<i>stone grey</i>																														
	900	WENGE'	<i>wenge</i>																														
	L140	153 <b>811</b> (*)	12	0,037	1	€ 50,00																											
	L160	153 <b>812</b> (*)	14	0,042	1	€ 56,00																											
	L180	153 <b>813</b> (*)	16	0,047	1	€ 61,00																											
	PIANO sp. 25mm <i>top thick. 25mm</i>		L120	152 <b>382</b> (*)	13	0,036	1	€ 54,00																									
	L140	152 <b>383</b> (*)	15	0,041	1	€ 60,00																											
L160	152 <b>384</b> (*)	17	0,047	1	€ 66,00																												
L180	152 <b>385</b> (*)	19	0,053	1	€ 74,00																												

L. x p.80 x H.

L. x p.80 x H.

L. x p.80 x H.

**PIANI TERMINALI PER BENCH***terminal tops for bench*

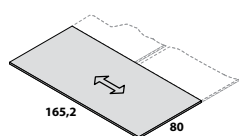
DESCRIZIONE <i>description</i>	L <i>w</i>	CODICE <i>code</i>	KG 	M <sup>3</sup> 	COLLI 	PREZZO <i>price</i>	(*) CODICE FINITURA <i>(*) finish code</i>																										
PIANO TERMINALE PER BENCH PROF. CM 80+80 <i>terminal desktop for bench 80+80 cms</i>    L.165,2 x p.80 x H.	PIANO sp. 18mm <i>top thick. 18mm</i>		L165,2	153 <b>829</b> (*)	16	0,064	1	€ 72,00	<table border="1"> <thead> <tr> <th>(*)</th> <th>PIANO</th> <th><i>top</i></th> </tr> </thead> <tbody> <tr><td>166</td><td>NOCE PAVIA</td><td><i>pavia walnut</i></td></tr> <tr><td>200</td><td>ACERO TAKI</td><td><i>taki maple</i></td></tr> <tr><td>400</td><td>BIANCO BR.</td><td><i>br. white</i></td></tr> <tr><td>704</td><td>ROVERE GREY</td><td><i>grey oak</i></td></tr> <tr><td>733</td><td>ROVERE</td><td><i>oak</i></td></tr> <tr><td>844</td><td>STONE GREY</td><td><i>stone grey</i></td></tr> <tr><td>900</td><td>WENGE'</td><td><i>wenge</i></td></tr> </tbody> </table>	(*)	PIANO	<i>top</i>	166	NOCE PAVIA	<i>pavia walnut</i>	200	ACERO TAKI	<i>taki maple</i>	400	BIANCO BR.	<i>br. white</i>	704	ROVERE GREY	<i>grey oak</i>	733	ROVERE	<i>oak</i>	844	STONE GREY	<i>stone grey</i>	900	WENGE'	<i>wenge</i>
	(*)	PIANO	<i>top</i>																														
	166	NOCE PAVIA	<i>pavia walnut</i>																														
	200	ACERO TAKI	<i>taki maple</i>																														
	400	BIANCO BR.	<i>br. white</i>																														
	704	ROVERE GREY	<i>grey oak</i>																														
733	ROVERE	<i>oak</i>																															
844	STONE GREY	<i>stone grey</i>																															
900	WENGE'	<i>wenge</i>																															
PIANO sp. 25mm <i>top thick. 25mm</i>		L165,2	152 <b>415</b> (*)	23	0,064	1	€ 87,00																										



↔ = VENATURA LEGNO / wood veining



**GAMBE METALLICHE A PONTE CON ALTEZZA REGOLABILE***bridge metal legs with adjustable height*

DESCRIZIONE <i>description</i>	L <i>w</i>	CODICE <i>code</i>	KG	M <sup>3</sup>	COLLI	PREZZO <i>price</i>	(*) CODICE FINITURA <i>(*) finish code</i>
GAMBE TERMINALI CON ALTEZZA REGOLABILE PER SCRIVANIE O BENCH SINGOLI <i>terminal legs with adjustable height            for single desk or single bench</i>	p.60	153 740 (*)	7	0,037	1	€ 166,00	
	p.80	153 741 (*)	8	0,049	1	€ 177,00	
	p.125	153 743 (*)	11	0,077	1	€ 213,00	
	p.165	153 744 (*)	11	0,098	1	€ 239,00	
	<b>ELEMENTO TELESCOPICO INTERNO SEMPRE COLORE ARGENTO</b> <i>inside telescopic element is always in silver colour</i>						
							(*) 000 ARGENTO <i>silver</i> 400 BIANCO <i>white</i> 551 ANTRACITE <i>anthracite</i> 844 STONE GREY <i>stone grey</i>

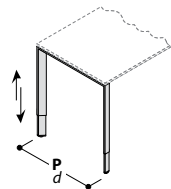

MIN H.62,4=MAX H.82,4

**SCRIVANIA SINGOLA**  
*single desk*
 ARGENTO  
 BIANCO  
 ANTRACITE  
 STONE GREY  
*silver  
 white  
 anthracite  
 stone grey*

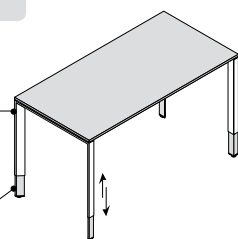
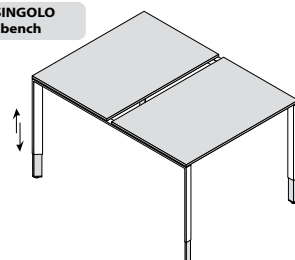
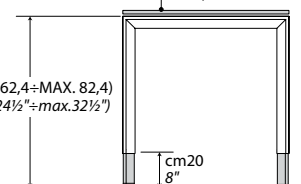
 ARGENTO  
*silver*
**BENCH SINGOLO**  
*single bench*PIANO SCRIVANIA sp. mm18-25  
*desk tops thick. 3/8" - 1"*(MIN. 62,4=MAX. 82,4)  
*(min.24½"=max.32½")***GAMBE METALLICHE A PONTE E KIT WIRE-MANAGER***bridge metal legs and wire-manager kit*

DESCRIZIONE <i>description</i>	L <i>w</i>	CODICE <i>code</i>	KG	M <sup>3</sup>	COLLI	PREZZO <i>price</i>	(*) CODICE FINITURA <i>(*) finish code</i>
GAMBE TERMINALI <i>terminal legs</i>	p.60	153 700 (*)	7	0,037	1	€ 96,00	
	p.80	153 701 (*)	8	0,049	1	€ 106,00	
	p.125	153 702 (*)	11	0,077	1	€ 128,00	
	p.165	153 703 (*)	13	0,098	1	€ 152,00	
GAMBE CENTRALI APERTE <i>open central legs</i>	p.80	153 707 (*)	7	0,062	1	€ 77,00	
	p.125	153 708 (*)	11	0,108	1	€ 106,00	
	p.165	153 709 (*)	15	0,149	1	€ 120,00	
							(*) 000 ARGENTO <i>silver</i> 400 BIANCO <i>white</i> 551 ANTRACITE <i>anthracite</i> 844 STONE GREY <i>stone grey</i>
KIT WIRE-MANAGER PER GAMBA A PONTE CENTRALE <i>wire-management kit for central bridge leg</i>	p.80	153 737 (*)	7	0,026	1	€ 98,00	
	p.125	153 738 (*)	10	0,046	1	€ 117,00	
	p.165	153 739 (*)	12	0,068	1	€ 119,00	

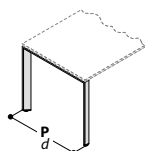

H.71

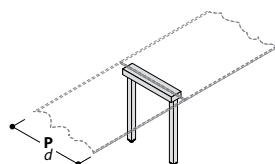

H.71

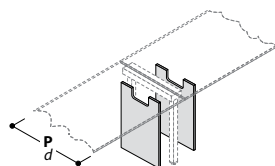

H.71

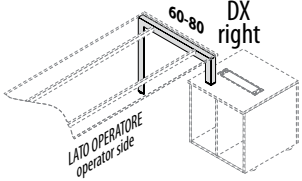
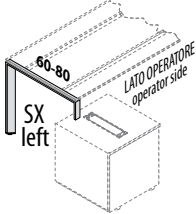
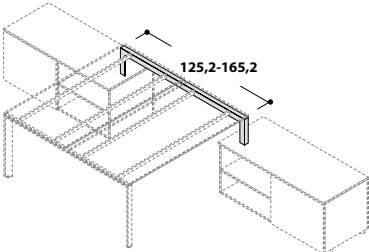
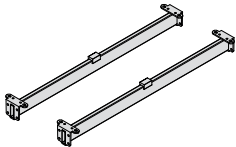
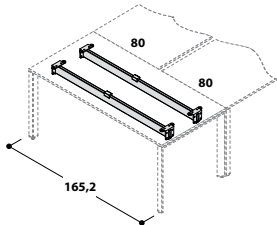

<b>GAMBE METALLICHE A PONTE TERMINALI DA APPOGGIO</b>								
<i>short terminal bridge metal legs</i>								
DESCRIZIONE <i>description</i>	L <i>w</i>	CODICE <i>code</i>	KG	M <sup>3</sup>	COLLI	PREZZO <i>price</i>	(*) CODICE FINITURA <i>(*) finish code</i>	
GAMBE TERMINALI <b>DX</b> DA APPOGGIO <i>right short terminal legs</i>  H.71								
	<b>DX</b>	p.60	153 <b>801</b> (*)	6	0,037	1	<b>€ 95,00</b>	
	<b>right</b>	p.80	153 <b>803</b> (*)	7	0,049	1	<b>€ 105,00</b>	
DA UTILIZZARE IN APPOGGIO SU MOBILI DI SERVIZIO O PORTA CPU (VEDI PAG.52-53) <i>put on service units or cpu-holder (please, you see pages 52-53)</i>								
GAMBE TERMINALI <b>SX</b> DA APPOGGIO <i>left short terminal legs</i>  H.71								
	<b>SX</b>	p.60	153 <b>802</b> (*)	6	0,037	1	<b>€ 95,00</b>	(*)
	<b>left</b>	p.80	153 <b>804</b> (*)	7	0,049	1	<b>€ 105,00</b>	<b>000</b> ARGENTO <i>silver</i>
DA UTILIZZARE IN APPOGGIO SU MOBILI DI SERVIZIO O PORTA CPU (VEDI PAG.52-53) <i>put on service units or cpu-holder (please, you see pages 52-53)</i>								
GAMBE TERMINALI DA APPOGGIO <i>short terminal legs</i>  H.71								
		p.125	153 <b>805</b> (*)	9	0,040	1	<b>€ 126,00</b>	<b>400</b> BIANCO <i>white</i>
		p.165	153 <b>806</b> (*)	10	0,051	1	<b>€ 150,00</b>	<b>551</b> ANTRACITE <i>anthracite</i>
DA UTILIZZARE IN APPOGGIO SU MOBILI DI SERVIZIO O PORTA CPU (VEDI PAG.52-53) <i>put on service units or cpu-holder (please, you see pages 52-53)</i>								
<b>TRAVI DI SUPPORTO</b> <i>support beams</i>								
COPPIA DI TRAVI PER GAMBE A PONTE <i>set of 2 beams for bridge legs</i> 								
			<b>PER PIANI</b> <i>for desktops</i>					(*)
	L.100	153 <b>720</b> (*)	2	0,016	1	<b>€ 61,00</b>	<b>000</b> ARGENTO <i>silver</i>	
L.120	153 <b>721</b> (*)	3	0,021	1	<b>€ 68,00</b>	<b>400</b> BIANCO <i>white</i>		
L.140	153 <b>722</b> (*)	4	0,024	1	<b>€ 74,00</b>	<b>551</b> ANTRACITE <i>anthracite</i>		
L.160	153 <b>723</b> (*)	5	0,027	1	<b>€ 81,00</b>	<b>844</b> STONE GREY <i>stone grey</i>		
L.180	153 <b>724</b> (*)	6	0,027	1	<b>€ 89,00</b>			
PER UTILIZZO VEDI SCHEMA PAGINA 38 <i>for use you see scheme to page 38</i>								
COPPIA DI TRAVI PER SCRIVANIE TERMINALI <i>set of 2 beams for terminal desks</i> 								
			<b>PER PIANI</b> <i>for desktops</i>					
L.165,2	153 <b>734</b> (*)	4	0,022	1	<b>€ 88,00</b>			

VASCHEE CENTRALI PASSA-CAVI PER BENCH E SCRIVANIE SINGOLE										
central cable trays for bench and single desks										
DESCRIZIONE	L	L	CODICE	KG	M <sup>3</sup>	COLLI	PREZZO	(*) CODICE FINITURA		
description	w	w	code				price	(*) finish code		
VASCHEE CENTRALI PASSACAVI <b>PER BENCH</b> <i>central cable trays for bench</i>		L90	153 <b>240</b> (*)	1,5	0,013	1	€ 42,00			
		L121	153 <b>242</b> (*)	1,5	0,022	1	€ 51,00			
	PER UTILIZZO VEDI SCHEMA PAGINA SEGUENTE for use you see scheme to next page									
	ABBINAMENTO A: for combining with:									
	COMPLETARE SEMPRE CON: always complete with:									
	A) BENCH								(*)	
	COPERTURA DA ART.200 A ART.223 (PAG.28) <i>cover from art.200 to art.223 (page 28)</i>								000	ARGENTO silver
	PANNELLO FRONTALE + COPERTURA DA ART.500 A ART.513 (PAG.28) <i>front panel + cover from art.500 to art.513 (page 28)</i>								400	BIANCO white
	BARRA ATTREZZABILE + COPERTURA DA ART.400 A ART.403 (PAG.30) <i>toolbar + cover from art.400 to art.403 (page 30)</i>								551	ANTRACITE anthracite
	PANNELLO FRONTALE CON BARRA ATTREZZABILE + COPERTURA DA ART.304 A ART.363 (PAG.32) <i>front panel + cover from art.304 to art.363 (page 32)</i>								844	STONE GREY stone grey
PER UTILIZZO SENZA COPERTURA SCEGLIERE TRA L'OPZIONE <A> OPPURE <B>										
<A> KIT 2 STAFFE ART.726 set of 2 stirrups art.726										
<B> KIT 2 TRAVERSI ART.719 set of 2 metal crossbars art.719										
L x p.20 x H.10										
KIT 2 STAFFE PER VASCHEE CENTRALI ART.240-242 <b>(SENZA COPERTURA)</b> <i>set of 2 stirrups for cable-trays art.240-242 (without cover profile)</i>			<A>	153 <b>726</b> (*)	1,5	0,001	1	€ 15,00		
	UTILIZZABILE SOLO SU BENCH CON PIANI FISSI SENZA COPERTURA use on bench with fixed tops only, without cover profile!								(*)	
									000	ARGENTO silver
KIT 2 TRAVERSI PER VASCHEE CENTRALI ART.240-242 <b>(SENZA COPERTURA)</b> <i>set of 2 metal crossbars for cable-trays art.240-242 (without cover profile)</i>			<B>	153 <b>719</b> (*)	1,5	0,001	1	€ 24,00		
	UTILIZZABILE SU BENCH CON PIANI FISSI E SCORREVOLI SENZA COPERTURA use on bench with fixed and sliding tops without cover profile								(*)	
									000	ARGENTO silver
VASCHEE PASSACAVI PER SCRIVANIE SINGOLE <i>cable tray for single desk</i>			L VASCHEE	PER TRAVI						
			w cable tray	for beams						
	L.70	L.100	152 <b>682</b> (*)	1,5	0,014	1	€ 21,00			
	L.90	L.120	152 <b>683</b> (*)	1,5	0,015	1	€ 26,00			
	L.110	L.140	152 <b>684</b> (*)	2	0,015	1	€ 32,00	(*)		
	L.130	L.160	152 <b>685</b> (*)	2	0,021	1	€ 39,00	000	ARGENTO silver	
	L.150	L.180	152 <b>686</b> (*)	2	0,021	1	€ 45,00	400	BIANCO white	
	L.170	L.200	152 <b>687</b> (*)	2,5	0,027	1	€ 53,00	551	ANTRACITE anthracite	
	L.190	L.220	152 <b>688</b> (*)	2,5	0,027	1	€ 57,00	844	STONE GREY stone grey	
	PER UTILIZZO VEDI SCHEMA PAGINA SEGUENTE for use you see scheme to next page									
L x p.12 x H.5										



**SCHEMA DI UTILIZZO TRAVI E VASCHETTA PORTA-CAVI**  
*scheme of using support beams and cable-tray*

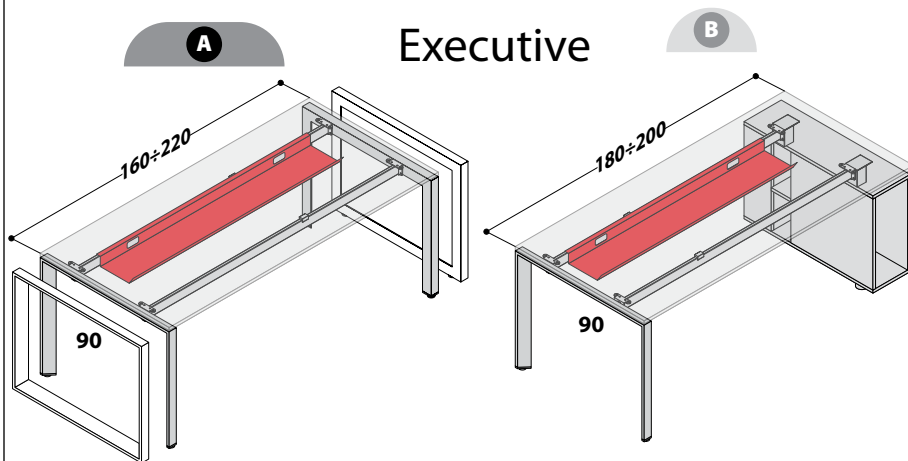

PIANO desk top		VASCHETTA PORTA-CAVI cable tray
<b>A</b>	L.160 w 63"	ART. 685
	L.180 w 71"	ART. 686
	L.200 w 78½"	ART. 687
	L.220 w 86¾"	ART. 688
<b>B</b>	L.180 w 71"	ART. 685
	L.200 w 78½"	ART. 686

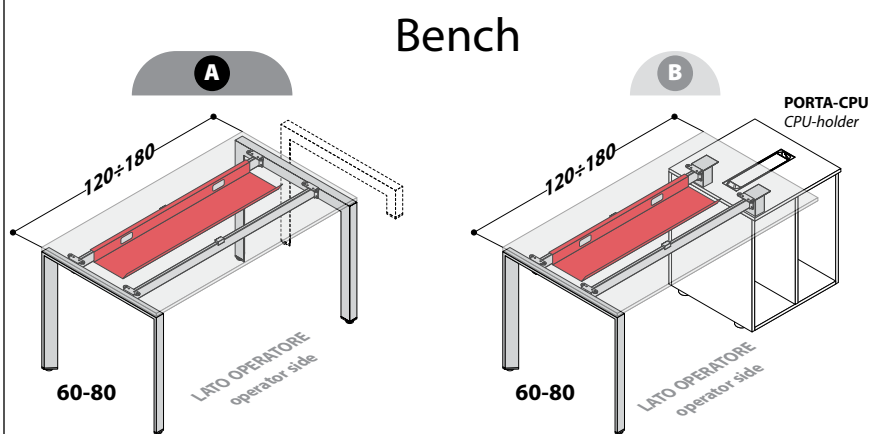

PIANO desk top		TRAVI beams	VASCHETTA PORTA-CAVI cable tray
<b>A</b>	L.120	ART. 721	ART. 683
	L.140	ART. 722	ART. 684
	L.160	ART. 723	ART. 685
	L.180	ART. 724	ART. 686
<b>B</b>	L.120	ART. 720	ART. 682
	L.140	ART. 721	ART. 683
	L.160	ART. 722	ART. 684
	L.180	ART. 723	ART. 685

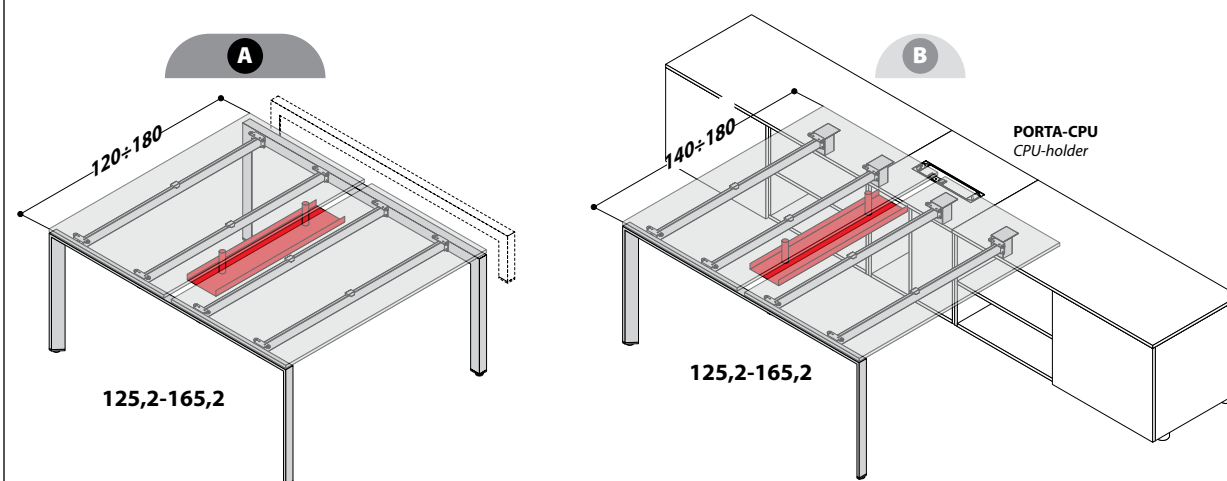

PIANO desk top		TRAVI beams	VASCHETTA CENTRALE PORTA-CAVI central cable tray
<b>A</b>	L.120	ART. 721	ART. 240
	L.140	ART. 722	ART. 242
	L.160	ART. 723	ART. 242
	L.180	ART. 724	ART. 242
<b>B</b>	L.140	ART. 721	ART. 240
	L.160	ART. 722	ART. 242
	L.180	ART. 723	ART. 242

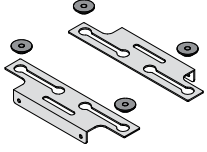
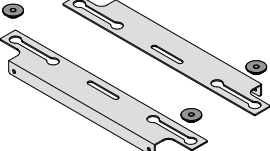
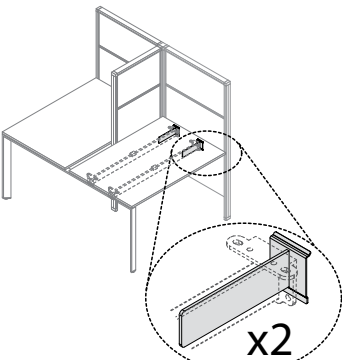
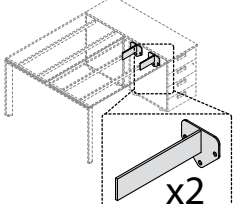
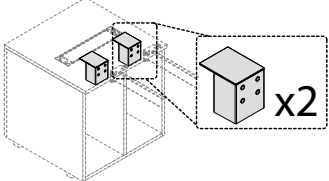
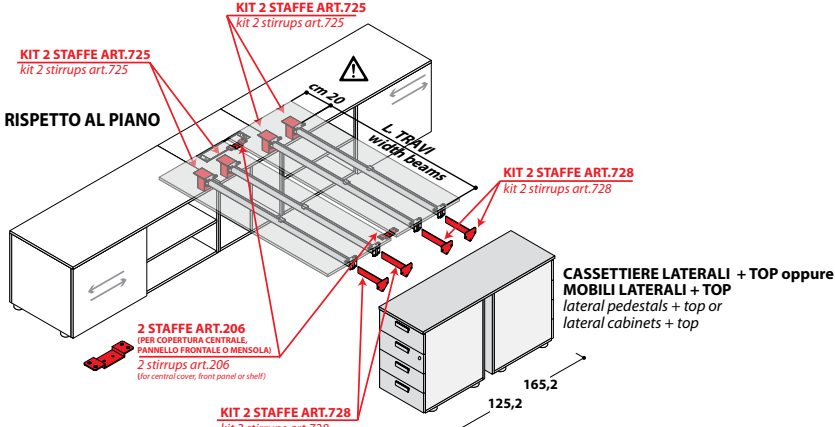
STAFFE stirrups																					
DESCRIZIONE description	L w	CODICE code	KG	M <sup>3</sup>	COLLI	PREZZO price	(*) CODICE FINITURA (*) finish code														
<b>KIT 2 STAFFE PER 1 PIANO SCORREVOLE PROF. CM 60</b> <b>kit 2 stirrups for 1 sliding desktop deep 60 cms</b>  L.29		<b>PROF. CM 60</b> <b>deep 60 cms</b>																			
	L.29	<b>153 748 (*)</b>	2	0,003	1	<b>€ 55,00</b>															
<b>FISSAGGIO SU 2 GAMBE A PONTE</b> fixing with 2 bridge legs																					
<b>KIT 2 STAFFE PER 1 PIANO SCORREVOLE PROF. CM 80-90</b> <b>kit 2 stirrups for 1 sliding desktop deep 80 cms-35½"</b>  L.48		<b>PROF. CM 80-90</b> <b>deep 80-90 cms</b>																			
	L.48	<b>153 749 (*)</b>	2	0,005	1	<b>€ 68,00</b>															
<b>FISSAGGIO SU 2 GAMBE A PONTE</b> fixing with 2 bridge legs																					
<b>KIT 2 STAFFE PER ATTACCO TRAVI A PARETINA</b> <b>kit 2 stirrups for connection with to partition panels</b>  x2																					
		<b>153 718 (*)</b>	2	0,006	1	<b>€ 30,00</b>	<table border="1"> <thead> <tr> <th>(*)</th> <th></th> <th></th> </tr> </thead> <tbody> <tr> <td>000</td> <td>ARGENTO</td> <td>silver</td> </tr> <tr> <td>400</td> <td>BIANCO</td> <td>white</td> </tr> <tr> <td>551</td> <td>ANTRACITE</td> <td>anthracite</td> </tr> <tr> <td>844</td> <td>STONE GREY</td> <td>stone grey</td> </tr> </tbody> </table>	(*)			000	ARGENTO	silver	400	BIANCO	white	551	ANTRACITE	anthracite	844	STONE GREY
(*)																					
000	ARGENTO	silver																			
400	BIANCO	white																			
551	ANTRACITE	anthracite																			
844	STONE GREY	stone grey																			
<b>FISSAGGIO SU 2 GAMBE A PONTE</b> fixing with 2 bridge legs																					
<b>KIT 2 STAFFE PER ATTACCO TRAVI SU CASSETTIERE LATERALI O MOBILI LATERALI</b> <b>kit 2 stirrups for fixing beams with lateral pedestals or lateral cabinets</b>  x2																					
		<b>153 728 (*)</b>	2	0,006	1	<b>€ 32,00</b>															
<b>FISSAGGIO SU 2 GAMBE A PONTE</b> fixing with 2 bridge legs																					
<b>KIT 2 STAFFE PER ATTACCO TRAVI SU PORTA-CPU</b> <b>kit 2 stirrups for fixing beams with CPU-holder</b>  x2																					
		<b>153 725 (*)</b>	2	0,001	1	<b>€ 28,00</b>															
<b>FISSAGGIO SU 2 GAMBE A PONTE</b> fixing with 2 bridge legs																					
<div style="display: flex; justify-content: space-between;"> <div style="width: 30%;"> <p><b>ATTENZIONE!</b> UTILIZZARE TRAVI CON LUNGHEZZA INFERIORE DI 20 CM RISPETTO AL PIANO ESEMPIO: CON PIANO L.160 UTILIZZARE TRAVI L.140 warning! use 20 cms shorter beam respect the top example: with w 160cms top use w 140cms beams</p> </div> <div style="width: 40%; text-align: center;">  </div> <div style="width: 25%; text-align: right;"> <p><b>CASSETTIERE LATERALI + TOP oppure MOBILI LATERALI + TOP</b> lateral pedestals + top or lateral cabinets + top</p> </div> </div>																					

# System

# 5<sup>TH</sup> ELEMENT



## • MENSOLE

MATERIALE: Pannello di particelle di legno sp. 12mm

FINITURA: Nobilitato in melaminico

COLORI: Argento Golf

CARATTERISTICA: Dotato di profilo orizzontale in alluminio estruso idoneo all'aggancio sulle paretine.

Le mensole sono disponibili con o senza illuminazione inferiore a led.

## • SHELVES

MATERIAL: Particleboard panel thick. 12mm

FINISH: Melamine-faced

COLOURS: Golf Silver

FEATURE: It is furnished with extruded aluminium profile to hook-up to the partition panels

The shelves are available with or without under led lamp

## • PARETINE

MATERIALE: Telaio perimetrale in alluminio estruso con elementi di tamponamento realizzati in pannelli di particelle di legno sp. 25mm oppure metacrilato sp. 5 mm

FINITURA TAMPONAMENTI: Disponibile in 3 tipologie

1) Nobilitato in melaminico: Acero Taki, Bianco Br., Wengè, Noce Pavia, Stone grey, Rovere, Rovere grey.

2) Rivestito in tessuto, colori Forsit (Cat. F): Poliestere Stretch Ignifugo : Azzurro sky, Verde bosco, Verde acido.

3) Metacrilato: bianco

CARATTERISTICA:

Utilizzo come sostegno strutturale di piani di lavoro. Dotate di piedini livellatori.

Le traverse orizzontali, in plastica estrusa, consentono l'aggancio di mensole e pensili porta-dox.

## • PARTITION PANELS

MATERIAL: aluminium frame with particleboard panel 25 mm thick. or methacrylate panel thick 5mm

FINISH: Available in 3 kinds:

1) Melamine-faced: Taki Maple, Br. White, Wengè, Pavia walnut, Stone grey, Oak, Grey oak.

2) Covered by fabric, Forsit colours (Cat. F): Fire-retardand Stretch Polyester: Sky blue, Wood green, Acid green .

3) Methacrylate: White

FEATURE:

They're used as support. Adjustable feet included.

The horizontal cross-bars , made of extruded plastic profile, allows quick snapping of shelves and suspended units.





#### • GAMBA A CORNICE

MATERIALE: Tubolare metallico a sezione rettangolare e quadrata  
 FINITURA: Verniciatura a polveri epossidiche nel colore Argento.  
 CARATTERISTICA: Predisposta per il fissaggio delle travi portanti e dei piani. Dotata di piedini livellatori. Aggancio rapido alla paretina

#### • FRAME LEG

MATERIAL: Metallic tubular with rectangular and squared section  
 FINISH: Painted with epoxy resin powder in colour Silver.  
 FEATURE: The leg is predisposed for to fix the supporting beams and tops. Adjustable feet included. Quick snapping to the partition panels.



#### • TOP ACCESS

MATERIALE: Cornice in plastica stampata e coperchio realizzato con pannello di particelle di legno sp. 8mm  
 COLORI: Cornice Argento e coperchio Acero Taki, Bianco Br., Wengè, Noce Pavia, Stone grey, Rovere, Rovere grey.  
 CARATTERISTICA: Coperchio dello stesso colore dei piani.

#### • TOP ACCESS

MATERIAL: Plastic frame and cover made of particleboard panel 8mm thick.  
 COLOURS: Silver frame and cover Taki Maple, Br. White, Wengè, Pavia walnut, Stone grey, Oak, Grey oak.  
 FEATURE: Cover is same colour of the tops.

#### • CANALINA PASSA-CAVI PER PARETINA

MATERIALE: Profilo in plastica estrusa  
 COLORE: Argento  
 CARATTERISTICA: Aggancio su traversa della paretina.

#### • CABLEWAY FOR PARTITION PANEL

MATERIAL: Extruded plastic profile  
 COLOURS: Silver  
 FEATURE: It is hooked up the cross-bar of the partition panel.

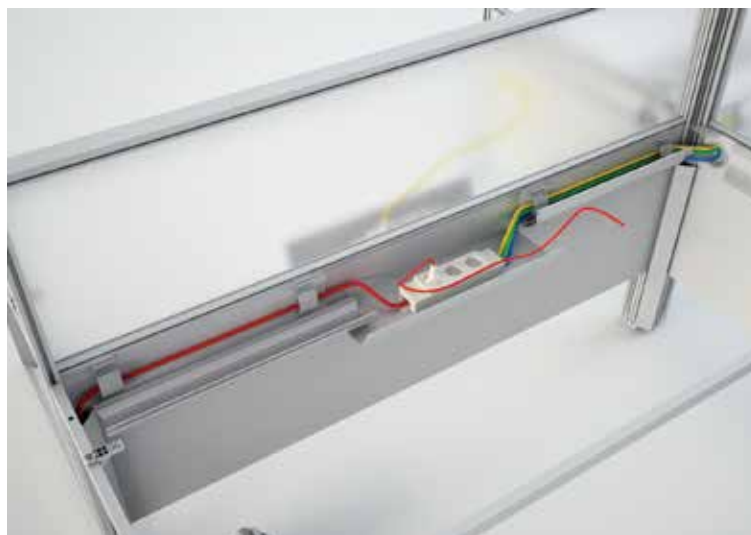

**SCHEMA BASAMENTI SOTTOPIANO E PARETINE UTILIZZABILI PER SUPPORTARE PIANI DI LAVORO**  
*base and partition panels for work tops*

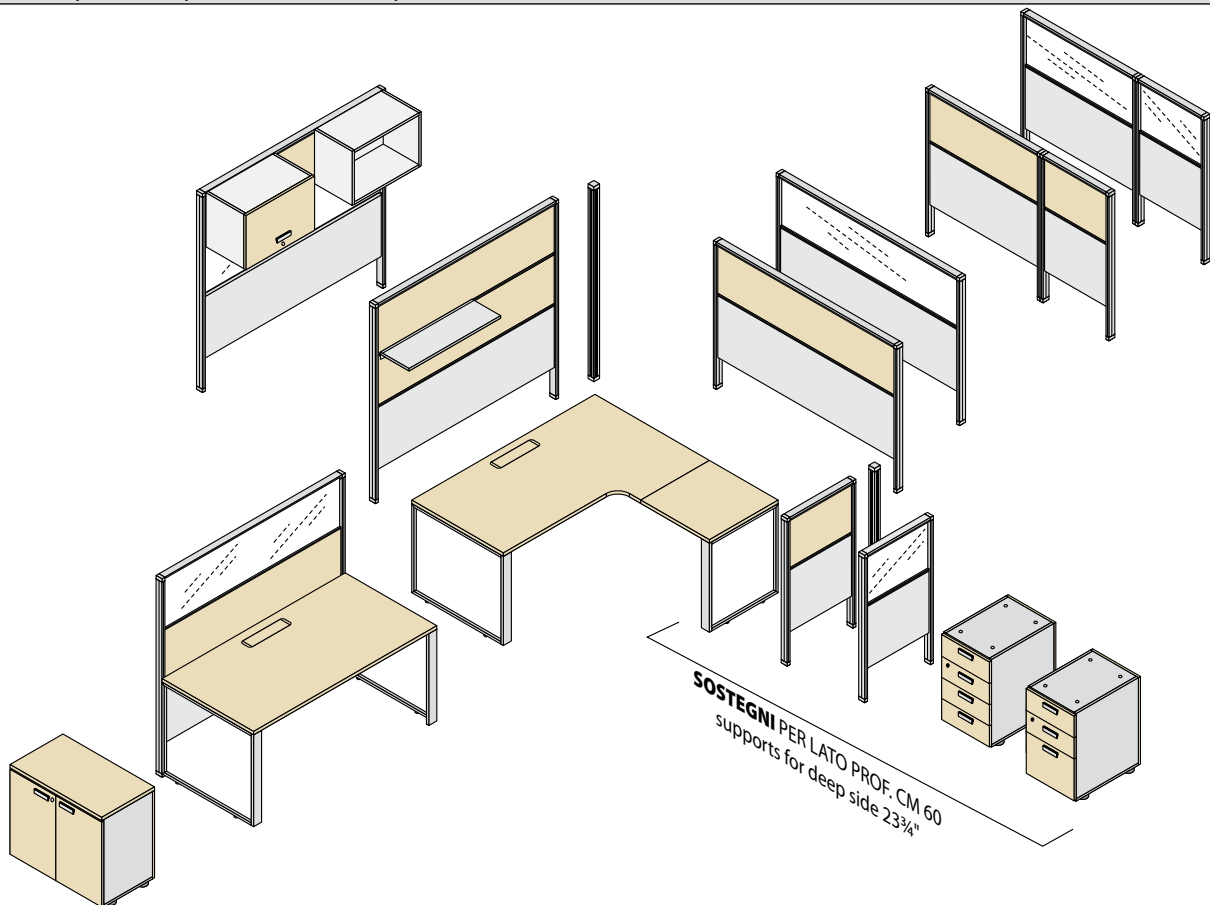

• **ESEMPIO ELETRIFICAZIONE COMPLESSIVA DEL SYSTEM**  
 • **EXAMPLE ELECTRIFICATION SYSTEM**

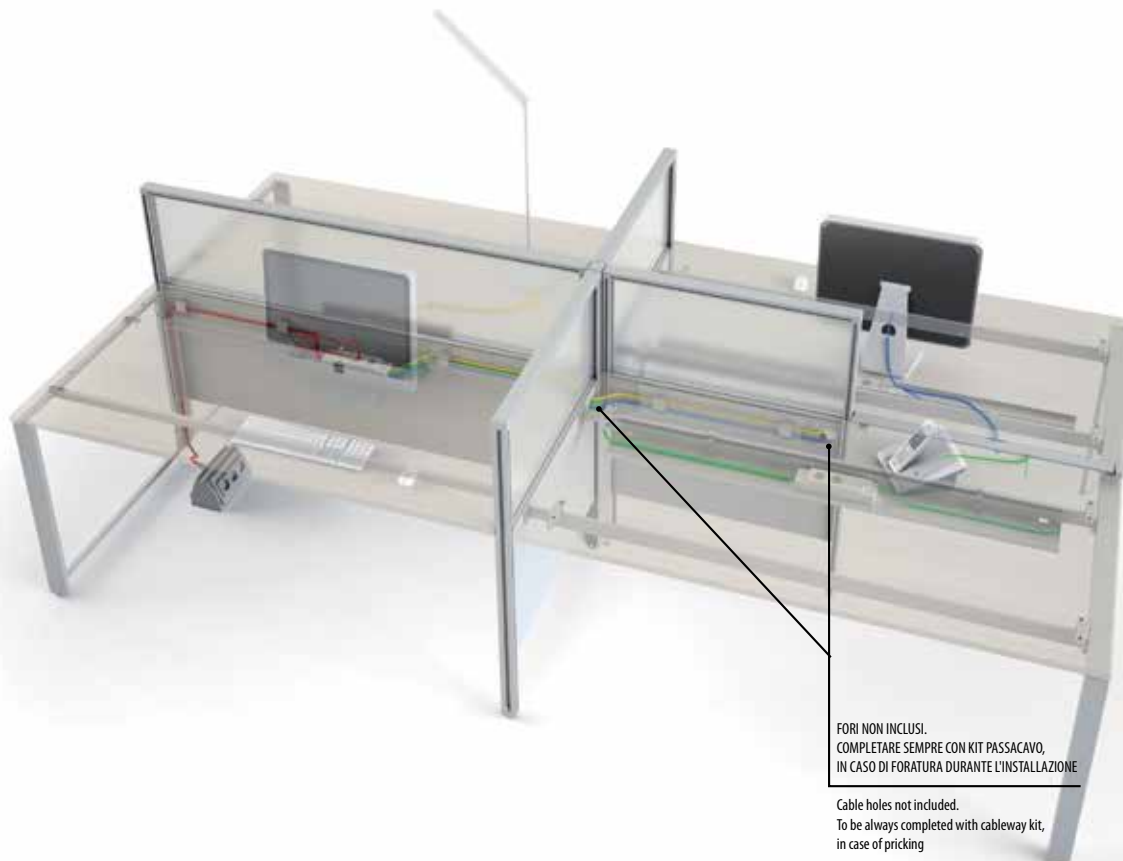

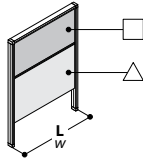
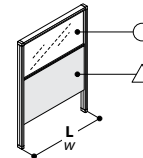

MODULI PARETINE H.111 partition panels h.111 cms																															
DESCRIZIONE description	L w	CODICE code	KG	M <sup>3</sup>	COLLI	PREZZO price	(*) CODICE FINITURA (*) finish code																								
MODULI CIECHI H.111 blind modules h.111 cms    N.B. : PER ANCORAGGIO PIANI <b>COMPLETARE SEMPRE</b> CON SET PIASTRINI (vedi schema pag.48) to anchor the tops <b>complete always</b> with set of plates (see scheme page 48)	<b>MELAMINICO</b> melamine						<table border="1"> <thead> <tr> <th>(*)</th> <th>MELAMINICO</th> <th>melamine</th> </tr> </thead> <tbody> <tr> <td>003</td> <td>ROVERE</td> <td>oak</td> </tr> <tr> <td>004</td> <td>ROVERE GREY</td> <td>grey oak</td> </tr> <tr> <td>020</td> <td>ACERO TAKI</td> <td>taki maple</td> </tr> <tr> <td>040</td> <td>BIANCO BR.</td> <td>br. white</td> </tr> <tr> <td>044</td> <td>STONE GREY</td> <td>stone grey</td> </tr> <tr> <td>066</td> <td>NOCE PAVIA</td> <td>pavia walnut</td> </tr> <tr> <td>090</td> <td>WENGE'</td> <td>wenge</td> </tr> </tbody> </table>	(*)	MELAMINICO	melamine	003	ROVERE	oak	004	ROVERE GREY	grey oak	020	ACERO TAKI	taki maple	040	BIANCO BR.	br. white	044	STONE GREY	stone grey	066	NOCE PAVIA	pavia walnut	090	WENGE'	wenge
	(*)	MELAMINICO	melamine																												
	003	ROVERE	oak																												
	004	ROVERE GREY	grey oak																												
	020	ACERO TAKI	taki maple																												
	040	BIANCO BR.	br. white																												
	044	STONE GREY	stone grey																												
	066	NOCE PAVIA	pavia walnut																												
	090	WENGE'	wenge																												
	L.60	152 <b>790</b> (*)	14	0,050	1	€ 121,00																									
	L.80	152 <b>792</b> (*)	16	0,066	1	€ 138,00																									
	L.100	152 <b>794</b> (*)	19	0,082	1	€ 153,00																									
	L.120	152 <b>795</b> (*)	22	0,098	1	€ 167,00																									
	L.140	152 <b>796</b> (*)	25	0,114	1	€ 188,00																									
	L.160	152 <b>797</b> (*)	27	0,130	1	€ 201,00	△																								
	L.180	152 <b>798</b> (*)	29	0,150	1	€ 214,00																									
	<b>TESSUTO</b> fabric							<table border="1"> <thead> <tr> <th>(*)</th> <th>TESSUTO POLIESTERE STRETCH IGNIFUGO</th> <th>fire-retardant stretch polyester fabric</th> </tr> </thead> <tbody> <tr> <td>320</td> <td>AZZURRO SKY</td> <td>sky blue</td> </tr> <tr> <td>323</td> <td>VERDE BOSCO</td> <td>wood green</td> </tr> <tr> <td>333</td> <td>VERDE ACIDO</td> <td>acid green</td> </tr> </tbody> </table>	(*)	TESSUTO POLIESTERE STRETCH IGNIFUGO	fire-retardant stretch polyester fabric	320	AZZURRO SKY	sky blue	323	VERDE BOSCO	wood green	333	VERDE ACIDO	acid green											
	(*)	TESSUTO POLIESTERE STRETCH IGNIFUGO	fire-retardant stretch polyester fabric																												
	320	AZZURRO SKY	sky blue																												
	323	VERDE BOSCO	wood green																												
333	VERDE ACIDO	acid green																													
L.60	152 <b>940</b> (*)	14	0,050	1	€ 151,00																										
L.80	152 <b>942</b> (*)	16	0,066	1	€ 176,00																										
L.100	152 <b>944</b> (*)	19	0,082	1	€ 201,00																										
L.120	152 <b>945</b> (*)	22	0,098	1	€ 222,00																										
L.140	152 <b>946</b> (*)	25	0,114	1	€ 254,00																										
L.160	152 <b>947</b> (*)	27	0,130	1	€ 275,00	△																									
L.180	152 <b>948</b> (*)	29	0,150	1	€ 298,00																										
L x p.5,2 x H.111							<table border="1"> <thead> <tr> <th>(*)</th> <th>TESSUTO POLIESTERE STRETCH IGNIFUGO</th> <th>fire-retardant stretch polyester fabric</th> </tr> </thead> <tbody> <tr> <td>320</td> <td>AZZURRO SKY</td> <td>sky blue</td> </tr> <tr> <td>323</td> <td>VERDE BOSCO</td> <td>wood green</td> </tr> <tr> <td>333</td> <td>VERDE ACIDO</td> <td>acid green</td> </tr> </tbody> </table>	(*)	TESSUTO POLIESTERE STRETCH IGNIFUGO	fire-retardant stretch polyester fabric	320	AZZURRO SKY	sky blue	323	VERDE BOSCO	wood green	333	VERDE ACIDO	acid green												
(*)	TESSUTO POLIESTERE STRETCH IGNIFUGO	fire-retardant stretch polyester fabric																													
320	AZZURRO SKY	sky blue																													
323	VERDE BOSCO	wood green																													
333	VERDE ACIDO	acid green																													
MODULI H.111 CON ELEMENTO SUPERIORE IN METACRILATO modules h.111 cms with upper methacrylate element    N.B. : PER ANCORAGGIO PIANI <b>COMPLETARE SEMPRE</b> CON SET PIASTRINI (vedi schema pag.48) to anchor the tops <b>complete always</b> with set of plates (see scheme page 48)	L.60	152 <b>800</b> (*)	13	0,050	1	€ 143,00																									
	L.80	152 <b>802</b> (*)	15	0,066	1	€ 176,00																									
	L.100	152 <b>804</b> (*)	18	0,082	1	€ 198,00	○																								
	L.120	152 <b>805</b> (*)	21	0,098	1	€ 250,00																									
	L.140	152 <b>806</b> (*)	24	0,114	1	€ 262,00																									
	L.160	152 <b>807</b> (*)	26	0,130	1	€ 302,00																									
	L.180	152 <b>808</b> (*)	28	0,150	1	€ 332,00																									
	L x p.5,2 x H.111							<table border="1"> <thead> <tr> <th>(*)</th> <th>METACRILATO BIANCO</th> <th>white methacrylate</th> </tr> </thead> <tbody> <tr> <td>000</td> <td>METACRILATO BIANCO</td> <td>white methacrylate</td> </tr> </tbody> </table>	(*)	METACRILATO BIANCO	white methacrylate	000	METACRILATO BIANCO	white methacrylate																	
	(*)	METACRILATO BIANCO	white methacrylate																												
	000	METACRILATO BIANCO	white methacrylate																												
L x p.5,2 x H.111							<table border="1"> <thead> <tr> <th>(*)</th> <th>METACRILATO BIANCO</th> <th>white methacrylate</th> </tr> </thead> <tbody> <tr> <td>000</td> <td>METACRILATO BIANCO</td> <td>white methacrylate</td> </tr> </tbody> </table>	(*)	METACRILATO BIANCO	white methacrylate	000	METACRILATO BIANCO	white methacrylate																		
(*)	METACRILATO BIANCO	white methacrylate																													
000	METACRILATO BIANCO	white methacrylate																													
L x p.5,2 x H.111							<table border="1"> <thead> <tr> <th>(*)</th> <th>METACRILATO BIANCO</th> <th>white methacrylate</th> </tr> </thead> <tbody> <tr> <td>000</td> <td>METACRILATO BIANCO</td> <td>white methacrylate</td> </tr> </tbody> </table>	(*)	METACRILATO BIANCO	white methacrylate	000	METACRILATO BIANCO	white methacrylate																		
(*)	METACRILATO BIANCO	white methacrylate																													
000	METACRILATO BIANCO	white methacrylate																													

## MODULI PARETINE H.150

partition panels h.150 cms

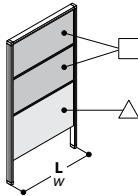
DESCRIZIONE description	L w	CODICE code	KG	M <sup>3</sup>	COLLI	PREZZO price	(*) CODICE FINITURA (*) finish code	
MODULO CIECO H.150 blind module h.150 cms   <p>N.B. : PER ANCORAGGIO PIANI <b>COMPLETARE SEMPRE</b> CON SET PIASTRINI (vedi schema pag.48) to anchor the tops <b>complete always</b> with set of plates (see scheme page 48)</p>	<b>MELAMINICO</b> melamine							
							(*) MELAMINICO melamine	
	L.60	152 910 (*)	19	0,067	1	€ 168,00	003 ROVERE oak	
	L.80	152 912 (*)	21	0,088	1	€ 191,00	004 ROVERE GREY grey oak	
	L.100	152 914 (*)	24	0,110	1	€ 215,00	020 ACERO TAKI taki maple	
	L.120	152 915 (*)	27	0,131	1	€ 234,00	040 BIANCO BR. br. white	
	L.140	152 916 (*)	30	0,152	1	€ 264,00	044 STONE GREY stone grey	
	L.160	152 917 (*)	32	0,173	1	€ 280,00	066 NOCE PAVIA pavia walnut	
	L.180	152 918 (*)	34	0,195	1	€ 298,00	090 WENGE' wenge	
							△ PANNELLO INFERIORE MELAMINICO COLORE ARGENTO GOLF lower melamine panel in golf silver colour	
	<b>TESSUTO</b> fabric							
	L.60	152 950 (*)	19	0,067	1	€ 229,00	(*) TESSUTO POLIESTERE STRETCH IGNIFUGO fire-retardant stretch polyester fabric	
	L.80	152 952 (*)	21	0,088	1	€ 267,00	320 AZZURRO SKY sky blue	
	L.100	152 954 (*)	24	0,110	1	€ 309,00	323 VERDE BOSCO wood green	
	L.120	152 955 (*)	27	0,131	1	€ 344,00	333 VERDE ACIDO acid green	
	L.140	152 956 (*)	30	0,152	1	€ 396,00		
	L.160	152 957 (*)	32	0,173	1	€ 429,00	△ PANNELLO INFERIORE MELAMINICO COLORE ARGENTO GOLF lower melamine panel in golf silver colour	
	L.180	152 958 (*)	34	0,195	1	€ 465,00		
	L. x p.5,2 x H.150							

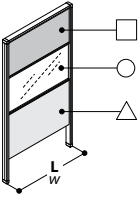
MODULI H.150 CON ELEMENTO INTERMEDIO IN METACRILATO modules h.150 cms with intermediate methacrylate element   <p>N.B. : PER ANCORAGGIO PIANI <b>COMPLETARE SEMPRE</b> CON SET PIASTRINI (vedi schema pag.48) to anchor the tops <b>complete always</b> with set of plates (see scheme page 48)</p>	<b>MELAMINICO</b> melamine							
							(*) MELAMINICO melamine	
	L.60	152 920 (*)	18	0,067	1	€ 182,00	003 ROVERE oak	
	L.80	152 922 (*)	20	0,088	1	€ 219,00	004 ROVERE GREY grey oak	
	L.100	152 924 (*)	23	0,110	1	€ 246,00	020 ACERO TAKI taki maple	
	L.120	152 925 (*)	26	0,131	1	€ 302,00	040 BIANCO BR. br. white	
	L.140	152 926 (*)	29	0,152	1	€ 323,00	044 STONE GREY stone grey	
	L.160	152 927 (*)	31	0,173	1	€ 365,00	066 NOCE PAVIA pavia walnut	
	L.180	152 928 (*)	33	0,195	1	€ 399,00	090 WENGE' wenge	
							△ PANNELLO INFERIORE MELAMINICO COLORE ARGENTO GOLF lower melamine panel in golf silver colour	
	<b>TESSUTO</b> fabric							
	L.60	152 960 (*)	18	0,067	1	€ 206,00	(*) TESSUTO POLIESTERE STRETCH IGNIFUGO fire-retardant stretch polyester fabric	
	L.80	152 962 (*)	20	0,088	1	€ 253,00	320 AZZURRO SKY sky blue	
	L.100	152 964 (*)	23	0,110	1	€ 285,00	323 VERDE BOSCO wood green	
	L.120	152 965 (*)	26	0,131	1	€ 348,00	333 VERDE ACIDO acid green	
	L.140	152 966 (*)	29	0,152	1	€ 376,00		
	L.160	152 967 (*)	31	0,173	1	€ 428,00	△ PANNELLO INFERIORE MELAMINICO COLORE ARGENTO GOLF lower melamine panel in golf silver colour	
	L.180	152 968 (*)	33	0,195	1	€ 468,00		
	L. x p.5,2 x H.150							

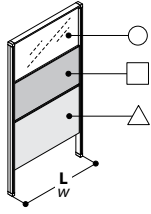
MODULI PARETINE H.150 partition panels h.150 cms																																
DESCRIZIONE description	L w	CODICE code	KG	M <sup>3</sup>	COLLI	PREZZO price	(*) CODICE FINITURA (* finish code)																									
MODULI H.150 CON ELEMENTO SUPERIORE IN METACRILATO modules h.150 cms with upper methacrylate element   <div style="border: 1px solid black; padding: 5px; width: fit-content;">             N.B. : PER ANCORAGGIO PIANI  <b>COMPLETARE SEMPRE</b>              CON SET PIASTRINI (vedi schema pag.48)              to anchor the tops <b>complete always</b>              with set of plates (see scheme page 48)           </div> L. x p.5,2 x H.150	<input checked="" type="checkbox"/> MELAMINICO melamine							<table border="1"> <thead> <tr> <th>(*)</th> <th>MELAMINICO</th> <th>melamine</th> </tr> </thead> <tbody> <tr><td>003</td><td>ROVERE</td><td>oak</td></tr> <tr><td>004</td><td>ROVERE GREY</td><td>grey oak</td></tr> <tr><td>020</td><td>ACERO TAKI</td><td>taki maple</td></tr> <tr><td>040</td><td>BIANCO BR.</td><td>br. white</td></tr> <tr><td>044</td><td>STONE GREY</td><td>stone grey</td></tr> <tr><td>066</td><td>NOCE PAVIA</td><td>pavia walnut</td></tr> <tr><td>090</td><td>WENGE'</td><td>wenge</td></tr> </tbody> </table>	(*)	MELAMINICO	melamine	003	ROVERE	oak	004	ROVERE GREY	grey oak	020	ACERO TAKI	taki maple	040	BIANCO BR.	br. white	044	STONE GREY	stone grey	066	NOCE PAVIA	pavia walnut	090	WENGE'	wenge
	(*)	MELAMINICO	melamine																													
	003	ROVERE	oak																													
	004	ROVERE GREY	grey oak																													
	020	ACERO TAKI	taki maple																													
	040	BIANCO BR.	br. white																													
	044	STONE GREY	stone grey																													
	066	NOCE PAVIA	pavia walnut																													
	090	WENGE'	wenge																													
	L.60	152 930 (*)	19	0,067	1	€ 182,00																										
	L.80	152 932 (*)	21	0,088	1	€ 219,00																										
	L.100	152 934 (*)	24	0,110	1	€ 246,00																										
	L.120	152 935 (*)	27	0,131	1	€ 302,00																										
	L.140	152 936 (*)	30	0,152	1	€ 323,00																										
	L.160	152 937 (*)	32	0,173	1	€ 365,00																										
	L.180	152 938 (*)	34	0,195	1	€ 399,00	<table border="1"> <thead> <tr> <th>△</th> <th colspan="2">PANNELLO INFERIORE MELAMINICO COLORE ARGENTO GOLF lower melamine panel in golf silver colour</th> </tr> </thead> <tbody> <tr><td></td><td></td><td></td></tr> </tbody> </table>	△	PANNELLO INFERIORE MELAMINICO COLORE ARGENTO GOLF lower melamine panel in golf silver colour																							
	△	PANNELLO INFERIORE MELAMINICO COLORE ARGENTO GOLF lower melamine panel in golf silver colour																														
	<input type="checkbox"/> TESSUTO fabric							<table border="1"> <thead> <tr> <th>(*)</th> <th>TESSUTO POLIESTERE STRETCH IGNIFUGO</th> <th>fire-retardant stretch polyester fabric</th> </tr> </thead> <tbody> <tr><td>320</td><td>AZZURRO SKY</td><td>sky blue</td></tr> <tr><td>323</td><td>VERDE BOSCO</td><td>wood green</td></tr> <tr><td>333</td><td>VERDE ACIDO</td><td>acid green</td></tr> </tbody> </table>	(*)	TESSUTO POLIESTERE STRETCH IGNIFUGO	fire-retardant stretch polyester fabric	320	AZZURRO SKY	sky blue	323	VERDE BOSCO	wood green	333	VERDE ACIDO	acid green												
	(*)	TESSUTO POLIESTERE STRETCH IGNIFUGO	fire-retardant stretch polyester fabric																													
	320	AZZURRO SKY	sky blue																													
	323	VERDE BOSCO	wood green																													
	333	VERDE ACIDO	acid green																													
	L.60	152 970 (*)	19	0,067	1	€ 206,00																										
L.80	152 972 (*)	21	0,088	1	€ 253,00																											
L.100	152 974 (*)	24	0,110	1	€ 285,00																											
L.120	152 975 (*)	27	0,131	1	€ 348,00																											
L.140	152 976 (*)	30	0,152	1	€ 376,00																											
L.160	152 977 (*)	32	0,173	1	€ 428,00	<table border="1"> <thead> <tr> <th>△</th> <th colspan="2">PANNELLO INFERIORE MELAMINICO COLORE ARGENTO GOLF lower melamine panel in golf silver colour</th> </tr> </thead> <tbody> <tr><td></td><td></td><td></td></tr> </tbody> </table>	△	PANNELLO INFERIORE MELAMINICO COLORE ARGENTO GOLF lower melamine panel in golf silver colour																								
△	PANNELLO INFERIORE MELAMINICO COLORE ARGENTO GOLF lower melamine panel in golf silver colour																															
L.180	152 978 (*)	34	0,195	1	€ 468,00																											

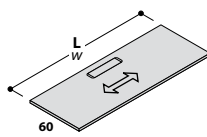
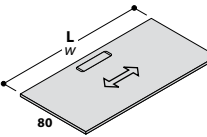
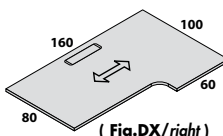

### PIANI SCRIVANIE BORDATI SP. 25mm (MELAMINICO) square edged desktops thick 25mm (melamine)

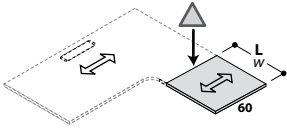
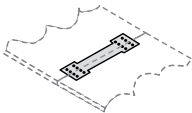
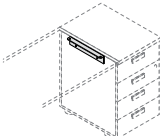
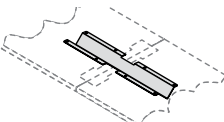
PIANI SCRIVANIE PROF. CM 60 desktops deep 60 cms   L. x p.60 x H.2,5	PIANO sp. 25mm top thick. 25mm		SENZA TOP ACCESS without top access																														
	L.120	152 382 (*)	13	0,036	1	€ 54,00																											
	L.140	152 383 (*)	15	0,041	1	€ 60,00																											
	L.160	152 384 (*)	17	0,047	1	€ 66,00																											
	L.180	152 385 (*)	19	0,053	1	€ 74,00																											
	PIANO sp. 25mm top thick. 25mm		CON TOP ACCESS with top access																														
	L.120	152 386 (*)	13	0,036	1	€ 93,00																											
	L.140	152 387 (*)	15	0,041	1	€ 102,00																											
	L.160	152 388 (*)	17	0,047	1	€ 109,00																											
	L.180	152 389 (*)	19	0,053	1	€ 116,00																											
	PIANI SCRIVANIE PROF. CM 80 desktops deep 80 cms   L. x p.80 x H.2,5	PIANO sp. 25mm top thick. 25mm		SENZA TOP ACCESS without top access					<table border="1"> <thead> <tr> <th>(*)</th> <th>PIANO</th> <th>top</th> </tr> </thead> <tbody> <tr><td>166</td><td>NOCE PAVIA</td><td>pavia walnut</td></tr> <tr><td>200</td><td>ACERO TAKI</td><td>taki maple</td></tr> <tr><td>400</td><td>BIANCO BR.</td><td>br. white</td></tr> <tr><td>704</td><td>ROVERE GREY</td><td>grey oak</td></tr> <tr><td>733</td><td>ROVERE</td><td>oak</td></tr> <tr><td>844</td><td>STONE GREY</td><td>stone grey</td></tr> <tr><td>900</td><td>WENGE'</td><td>wenge</td></tr> </tbody> </table>	(*)	PIANO	top	166	NOCE PAVIA	pavia walnut	200	ACERO TAKI	taki maple	400	BIANCO BR.	br. white	704	ROVERE GREY	grey oak	733	ROVERE	oak	844	STONE GREY	stone grey	900	WENGE'	wenge
		(*)	PIANO	top																													
166		NOCE PAVIA	pavia walnut																														
200		ACERO TAKI	taki maple																														
400		BIANCO BR.	br. white																														
704		ROVERE GREY	grey oak																														
733		ROVERE	oak																														
844		STONE GREY	stone grey																														
900		WENGE'	wenge																														
L.120		152 392 (*)	17	0,052	1	€ 64,00																											
L.140		152 393 (*)	20	0,060	1	€ 75,00																											
L.160		152 394 (*)	23	0,069	1	€ 84,00																											
L.180	152 395 (*)	26	0,077	1	€ 92,00																												
PIANO sp. 25mm top thick. 25mm		CON TOP ACCESS with top access																															
L.120	152 396 (*)	17	0,052	1	€ 108,00																												
L.140	152 397 (*)	20	0,060	1	€ 117,00																												
L.160	152 398 (*)	23	0,069	1	€ 127,00																												
L.180	152 399 (*)	26	0,077	1	€ 138,00																												
PIANO WORKSTATION L.160x100 workstation top w 24 3/4" x 39 1/2"   ( Fig.DX/ right ) L.160 x p.80/100 x H.2,5	PIANO sp. 25mm top thick. 25mm		CON TOP ACCESS with top access																														
	DX right	L.160	152 404 (*)	24	0,077	1	€ 150,00																										
	SX left	L.160	152 405 (*)																														

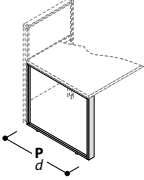
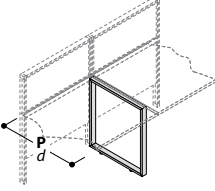
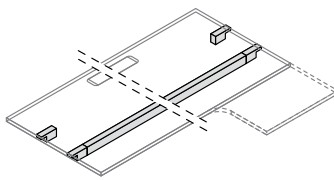
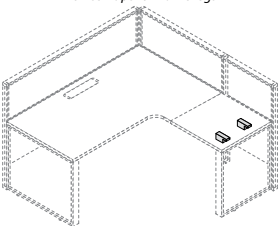
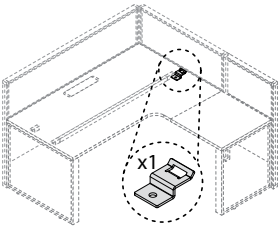
<b>ALLUNGHI SP. 25mm (MELAMINICO)</b> <i>square edged extensions and tops thick 25mm (melamine)</i>								
DESCRIZIONE <i>description</i>	L <i>w</i>	CODICE <i>code</i>	KG	M <sup>3</sup>	COLLI	PREZZO <i>price</i>	(*) CODICE FINITURA <i>(*) finish code</i>	
ALLUNGHI <b>CON VENATURA TRASVERSALE</b> <i>extensions with transversal wood veining</i>    L. x p.60 x H.2,5		PIANO sp. 25mm <i>top thick. 25mm</i>	CON VENATURA TRASVERSALE <i>transversal wood veining</i>				(*)	PIANO <i>top</i>
	L.60	152 <b>433</b> (*)	7	0,020	1	€ 31,00	166	NOCE PAVIA <i>pavia walnut</i>
	L.80	152 <b>434</b> (*)	9	0,024	1	€ 39,00	200	ACERO TAKI <i>taki maple</i>
	L.100	152 <b>435</b> (*)	11	0,030	1	€ 46,00	400	BIANCO BR. <i>br. white</i>
							704	ROVERE GREY <i>grey oak</i>
		COMPLETARE SEMPRE CON STAFFA ART.430 <i>always complete with stirrup art.430</i>					733	ROVERE <i>oak</i>
							844	STONE GREY <i>stone grey</i>
							900	WENGE' <i>wenge</i>
STAFFA DI COLLEGAMENTO PIANI <i>stirrup for fixing tops</i>  	L.44	152 <b>430</b> (*)	1	0,007	1	€ 19,00		
STAFFA <i>stirrup</i>    L.34 x p.3 x H.5		152 <b>431</b> (*)	1	0,003	1	€ 19,00	(*)	STAFFA <i>stirrup</i>
							000	ARGENTO <i>silver</i>
STAFFA SUPPLEMENTARE DI RINFORZO PER ALLUNGHI <i>additional undertop stirrup for extension</i>  	L.50	153 <b>659</b> (*)	1	0,004	1	€ 23,00		

MONTANTI, GAMBE A CORNICE, TRAVI E STAFFE PER PARETINE							
uprights, frame legs, beams and stirrups for partition panels							
DESCRIZIONE description		CODICE code	KG	M <sup>3</sup>	COLLI	PREZZO price	(*) CODICE FINITURA (*) finish code
MONTANTI PER PARETINE upright for partition panels    L.4,7 x p.4,7 x H.		H.111	152 890 (*)	3	0,013	1	€ 32,00
		H.150	152 891 (*)	3	0,017	1	€ 43,00
GAMBA A CORNICE <b>TERMINALE DX O SX</b> right or left terminal frame leg    H.71		p.60	152 893 (*)	5	0,041	1	€ 61,00
		p.80	152 895 (*)	6	0,054	1	€ 69,00
	<b>COMPLETARE SEMPRE CON TRAVI DA ART.903 A 906 OPPURE CON STAFFE ART.899</b> <i>to be always complete with beams from art.903 till 906 or stirrups art.899</i>						
GAMBA A CORNICE <b>CENTRALE</b> central frame leg    H.71		p.60	152 894 (*)	5	0,026	1	€ 72,00
		p.80	152 896 (*)	6	0,031	1	€ 78,00
	<b>COMPLETARE SEMPRE CON TRAVI DA ART.903 A 906 OPPURE CON STAFFE ART.899</b> <i>to be always complete with beams from art.903 till 906 or stirrups art.899</i>						
KIT TRAVI PER GAMBE A CORNICE kit of beams for frame legs  		L.120	152 903 (*)	2	0,008	1	€ 37,00
		L.140	152 904 (*)	2	0,008	1	€ 40,00
		L.160	152 905 (*)	3	0,009	1	€ 44,00
		L.180	152 906 (*)	5	0,012	1	€ 48,00
	<b>UTILIZZARE IL KIT TRAVI LUNGO IL LATO DEL TOP ACCESS</b> <i>use the kit beams on side of the top access</i>						
KIT 2 STAFFE PER GAMBE A CORNICE kit 2 stirrups for frame legs  			152 899 (*)	1,5	0,001	1	€ 13,00
STAFFA PER ATTACCO GAMBA A CORNICE-TRAVE-PARETINA stirrup for connection frame leg-beam-partition panel  			152 898 (*)	0,1	0,001	1	€ 10,00

**KIT PIASTRINI PER SUPPORTO PIANI SU PARETINE***kit of support plates for desktops with panels system*

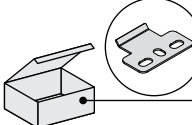
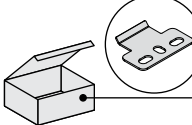
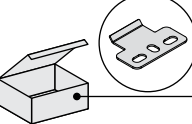
DESCRIZIONE <i>description</i>	L <i>w</i>	CODICE <i>code</i>	KG 	M <sup>3</sup> 	COLLI 	PREZZO <i>price</i>	(*) CODICE FINITURA <i>(*) finish code</i>
KIT 2 PIASTRINI REGGI-PIANO SU PARETINE <i>kit 2 plates for fixing desktops with partition panels</i>  <b>2 PEZZI</b> <i>2 pieces</i>		152 907 (*)	1,5	0,001	1	€ 12,00	
KIT 4 PIASTRINI REGGI-PIANO SU PARETINE <i>kit 4 plates for fixing desktops with partition panels</i>  <b>4 PEZZI</b> <i>4 pieces</i>		152 908 (*)	2	0,001	1	€ 18,00	(*) 000 ARGENTO silver
KIT 12 PIASTRINI REGGI-PIANO SU PARETINE <i>kit 12 plates for fixing desktops with partition panels</i>  <b>12 PEZZI</b> <i>12 pieces</i>		152 909 (*)	3	0,001	1	€ 46,00	

**SCHEMA DI UTILIZZO KIT PIASTRINI ART.907-908-909 E STAFFA ART.898***scheme of using support plates art.907-908-909 and stirrup art.898*\* **N.B.:** PER SOSTENERE I PIANI INCLUDERE **SEMPRE** I PIASTRINI DI SOSTEGNO ART. 907-908-909 secondo lo schema seguente:\* **N.B.:** to support the tops, **always** include supporting plates art. 907-908-909 as per the following scheme:

Esempi/ examples:

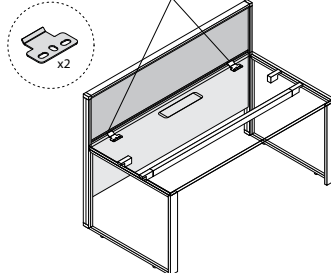
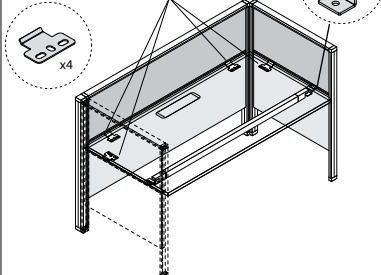
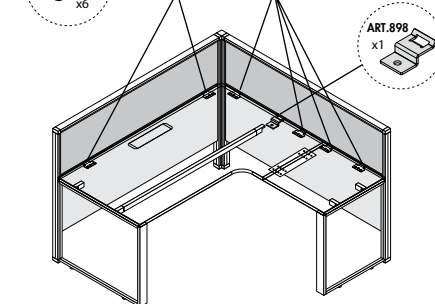
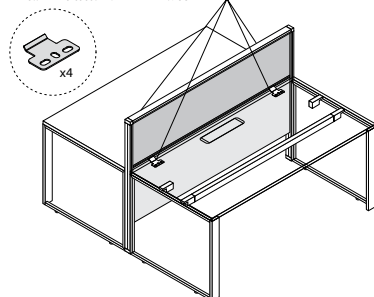
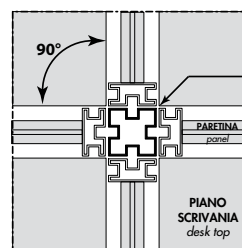
**A) -** COMPOSIZIONI CON PARETINA DA 1 SOLO LATO  
*compositions with partition on one side only*ES.: IN QUESTO CASO: N° 1 KIT ART.907  
ES.: in this case: N° 1 KIT ART.907ORDINARE **SEMPRE** n°2 PIASTRINI PER CIASCUN PIANO DA SOSTENERE **always** order 2 plates for each panel**B) -** COMPOSIZIONI CON PARETINE SU 3 LATI  
*compositions with partition on three side*ES.: IN QUESTO CASO: N° 1 KIT ART.908  
ES.: in this case: N° 1 KIT ART.908**C) -** COMPOSIZIONI CON PARETINE SU 2 LATI  
*compositions with partition on two side*ES.: IN QUESTO CASO: N° 1 KIT ART.907 + 908  
ES.: in this case: N° 1 KIT ART.907+ 908**D) -** COMPOSIZIONI PARETINA CON PIANI CONTRAPPOSTI  
*panel compositions with front tops*ES.: IN QUESTO CASO: N° 1 KIT ART.908  
ES.: in this case: N° 1 KIT ART.908Per composizioni di paretine **CENTRALI** con piani contrapposti completare **SEMPRE** con n°4 piastrini per ciascun pannello **for central panel compositions with faced tops, complete always with 4 plates for each panel**PER OGNI CONNESSIONE A 2-3-4 VIE **ORTOGONALI** CON PANNELLI PARETINA OCCORRE INSERIRE 1 MONTANTE DI RACCORDO ART. 890-891  
*for each 2-3-4 orthogonal way connection with panel it is necessary to use 1 joining upright art.890-891*ART. 890 (MONTANTE H.111) / (upright h.111 cms)  
ART. 891 (MONTANTE H.150) / (upright h.150 cms)

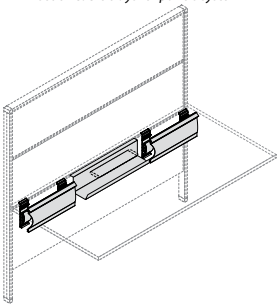
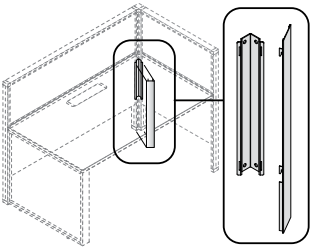
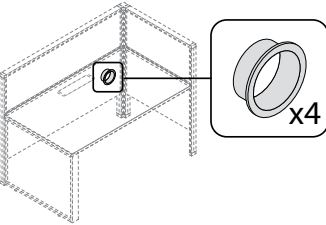
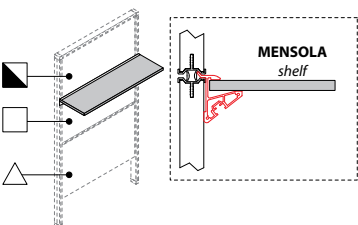
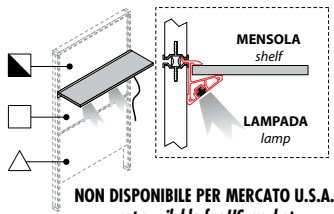
CANALINE PASSACAVI PER PARETINE cable trays for partition panels													
DESCRIZIONE description	L w	CODICE code	KG	M <sup>3</sup>	COLLI	PREZZO price	(*) CODICE FINITURA (*) finish code						
KIT CANALINE PASSA-CAVI PER SISTEMA PARETINE set of cable trays for panels system   H.11		152 699 (*)	1,2	0,014	1	€ 55,00							
		152 700 (*)	1,2	0,014	1	€ 63,00							
	PROSPETTO INFORMATIVO fact-sheet <table border="1"> <tr> <td>KIT PASSACAVI set of cable trays</td> <td>UTILIZZABILE SU PIANI usable on the desktops</td> </tr> <tr> <td>ART.699</td> <td>L.120-140</td> </tr> <tr> <td>ART.700</td> <td>L.160-180</td> </tr> </table>		KIT PASSACAVI set of cable trays	UTILIZZABILE SU PIANI usable on the desktops	ART.699	L.120-140	ART.700	L.160-180					
KIT PASSACAVI set of cable trays	UTILIZZABILE SU PIANI usable on the desktops												
ART.699	L.120-140												
ART.700	L.160-180												
SALITA PASSA-CAVI PER SISTEMA PARETINE rising cable tray for panels system   L.4 x p.4 x H.39		152 701 (*)	1,2	0,002	1	€ 30,00	(*) 000 ARGENTO silver						
KIT 4 PASSA-CAVI Ø 60mm PER PANNELLI PARETINE set of 4 cable-ways Ø 2 1/4" for partition panels   Ø 6		152 759 (*)	1	0,002	1	€ 18,00							
MENSOLE PER PARETINE H.150 shelves for partition panels h.150 cms													
MENSOLE CON BARRA DI SUPPORTO PER MODULI CIECHI H.150 shelves with support bar for blind module h.150 cms   L.x p.28 x H.1,2	L.60	152 704 (*)	2,4	0,012	2	€ 33,00							
	L.80	152 706 (*)	2,4	0,015	2	€ 40,00							
	L.100	152 708 (*)	2,4	0,018	2	€ 49,00							
MENSOLE CON BARRA DI SUPPORTO PER MODULI CIECHI H.150 CON LAMPADA A LED shelves with support bar for blind module h.150 cms with led lamp   L.x p.28 x H.1,2  <b>NON DISPONIBILE PER MERCATO U.S.A.</b> not available for US market	L.60	152 715 (*)	2,4	0,015	2	€ 133,00	(*) 000 ARGENTO GOLF golf silver						

## PENSILI PORTA-DOX PER PARETINE H.150

suspended storage cabinets for partitions panels h.150 cms

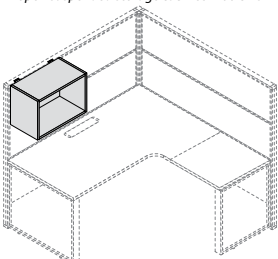
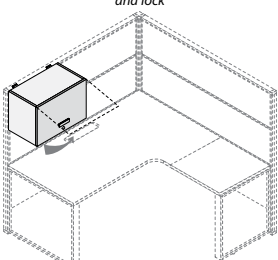
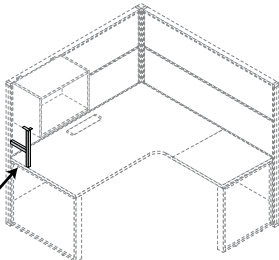
DESCRIZIONE description	L w	CODICE code	KG	M <sup>3</sup>	COLLI	PREZZO price	(*) CODICE FINITURA (*) finish code	
PENSILE PORTA-DOX A GIORNO L.60 <i>open suspended storage cabinet w 60 cms</i>  L.60 x p.33 x H.41	L.60	152 266 (*)	11	0,026	1	€ 56,00	(*)	STRUTTURA structure
							000	ARGENTO GOLF golf silver
PENSILE PORTA-DOX L.60 CON 1 ANTA LEGNO BASCULANTE E SERRATURA <i>suspended storage cabinet w 60 cms with 1 wooden door            and lock</i>  L.60 x p.35 x H.41	L.60	152 267 (*)	15	0,058	2	€ 190,00	(*)	ANTA STRUTTURA door structure
							003	ROVERE ARGENTO GOLF oak golf silver
							004	ROVERE GREY ARGENTO GOLF grey oak golf silver
							020	ACERO TAKI ARGENTO GOLF taki maple golf silver
							040	BIANCO BR. ARGENTO GOLF br. white golf silver
							044	STONE GREY ARGENTO GOLF stone grey golf silver
							066	NOCE PAVIA ARGENTO GOLF pavia walnut golf silver
							090	WENGE' ARGENTO GOLF wenge' golf silver
SOSTEGNO PER PENSILI PORTA-DOX (OPTIONAL) <i>support for suspended storage cabinets (optional)</i>  L.2 x p.11 x H.34		152 268 (*)	2	0,003	1	€ 29,00	(*)	
							000	ARGENTO silver

UTILIZZARE  
CON SOSTEGNO ART.268  
always use support art.268

ATT: .UTILIZZARE UN SOLO PORTA-DOX PER OGNI OPERATORE  
att. : use 1 storage cabinet for each user

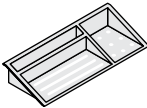
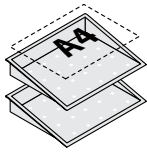

ACCESSORI accessories							
DESCRIZIONE description	L w	CODICE code	KG	M <sup>3</sup>	COLLI	PREZZO price	(*) CODICE FINITURA (* finish code)
PORTA-PENNE pen-holder    L.8,5 x p.9,5 x H.9	L.8,5	152 351 (*)	1,5	0,002	2	€ 30,00	
PORTA-OGGETTI objects-holder    L.38 x p.15 x H.6	L.38	152 352 (*)	1,5	0,002	2	€ 54,00	
KIT 2 PORTA-CARTA set of 2 paper-holder    L.35 x p.27 x H.6	L.35	152 353 (*)	1,5	0,002	2	€ 69,00	

(*)	ACCESSORI	accessories
999	TRASPARENTE	transparent

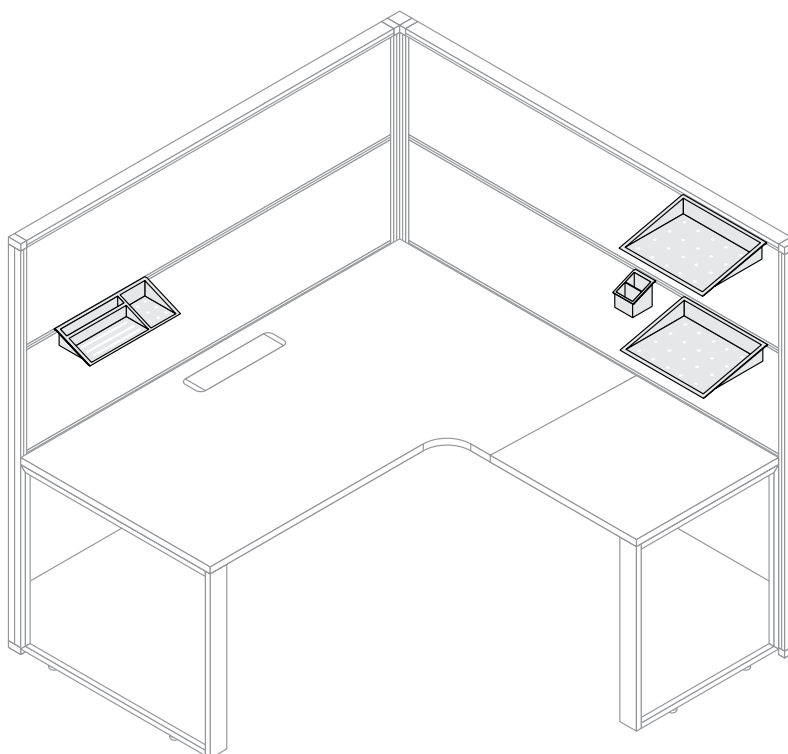

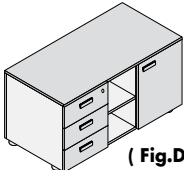
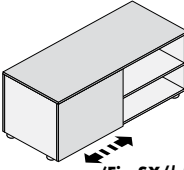
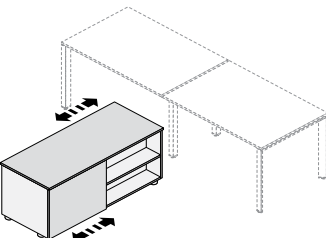
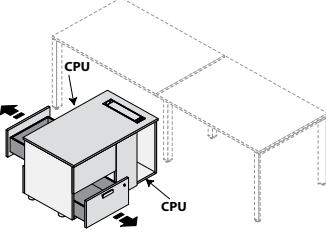
MOBILI DI SERVIZIO E PORTA-CPU service units and CPU-holder							UTILIZZABILI SU BENCH E SYSTEM usable for combining with BENCH and SYSTEM					
DESCRIZIONE description	CODICE code	KG	M <sup>3</sup>	COLLI	PREZZO price	(*) CODICE FINITURA (*) finish code						
MOBILE DI SERVIZIO L.120 CON 3 CASSETTI, VANO A GIORNO E 1 ANTA CIECA service unit w 120 cms with 3 drawers, open compartment and 1 wooden door   ( Fig.DX/right )	CASSETTI IN LEGNO wooden drawers		CON CHIUSURA AMMORTIZZATA with soft-close			VERSIONE MONO-COLORE / single-color version						
	DX right	152 778 (*)	41	0,390	1	€ 347,00	(*)					
	SX left	152 779 (*)					000	ARGENTO GOLF	golf silver			
	ABBINAMENTO A: for combining with:	FUNZIONE: function:	COMPLETARE SEMPRE CON: always complete with:			400	BIANCO BR.	br. white				
1- BENCH	FREE-STANDING					551	ANTRACITE	anthracite				
2- SYSTEM	FREE-STANDING					844	STONE GREY	stone grey				
L.120 x p.52,5 x H.61,5						VERSIONE BI-COLORE / double-color version						
MOBILE DI SERVIZIO L.140 TERMINALE DX O SX CON ANTINA SCORREVOLE E VANO A GIORNO right or left terminal service unit w 140 cms with sliding door and open compartment   ( Fig.SX/left )	CASSETTI IN LEGNO wooden drawers		CON CHIUSURA AMMORTIZZATA with soft-close			FRONTALI + SCHIENA + TOP			STRUTTURA	fronts + back panel + top	structure	
		152 454 (*)	47	0,167	2	€ 264,00	(*)	ROVERE	ARGENTO GOLF	oak	golf silver	
	ABBINAMENTO A: for combining with:	FUNZIONE: function:	COMPLETARE SEMPRE CON: always complete with:			003	ROVERE GREY	ARGENTO GOLF	grey oak	golf silver		
	1- BENCH	FREE-STANDING					011	GIALLO FRESIA	ARGENTO GOLF	freesia yellow	golf silver	
2- SYSTEM	FREE-STANDING					020	ACERO TAKI	ARGENTO GOLF	taki maple	golf silver		
L.140 x p.60 x H.61,5						032	AZZURRO SKY	ARGENTO GOLF	sky blue	golf silver		
						033	AMARANTO	ARGENTO GOLF	amaranth	golf silver		
						040	BIANCO BR.	ARGENTO GOLF	br. white	golf silver		
						044	STONE GREY	ARGENTO GOLF	stone grey	golf silver		
						051	ANTRACITE	ARGENTO GOLF	anthracite	golf silver		
						066	NOCE PAVIA	ARGENTO GOLF	pavia walnut	golf silver		
						090	WENGÈ	ARGENTO GOLF	wengè	golf silver		
						096	VERDE BOSCO	ARGENTO GOLF	wood green	golf silver		
MOBILE DI SERVIZIO L.140 CENTRALE CON ANTINE SCORREVOLI E VANI PORTA-OGGETTI BIFACCIALI central service unit w 140 cms with sliding doors and open glove compartment in double-side   ( Fig.SX/left )	CASSETTI IN LEGNO wooden drawers		CON CHIUSURA AMMORTIZZATA with soft-close			ROVERE			BIANCO BR.	oak	br. white	
		152 457 (*)	47	0,180	2	€ 335,00	403	ROVERE GREY	BIANCO BR.	grey oak	br. white	
	ABBINAMENTO A: for combining with:	FUNZIONE: function:	COMPLETARE SEMPRE CON: always complete with:			405	ARGENTO GOLF	BIANCO BR.	golf silver	br. white		
	1- BENCH	FREE-STANDING					411	GIALLO FRESIA	BIANCO BR.	freesia yellow	br. white	
2- SYSTEM	FREE-STANDING					420	ACERO TAKI	BIANCO BR.	taki maple	br. white		
L.140 x p.60 x H.61,5						432	AZZURRO SKY	BIANCO BR.	sky blue	br. white		
						433	AMARANTO	BIANCO BR.	amaranth	br. white		
						444	STONE GREY	BIANCO BR.	stone grey	br. white		
						451	ANTRACITE	BIANCO BR.	anthracite	br. white		
						466	NOCE PAVIA	BIANCO BR.	pavia walnut	br. white		
						490	WENGÈ	BIANCO BR.	wengè	br. white		
						496	VERDE BOSCO	BIANCO BR.	wood green	br. white		
						503	ROVERE	ANTRACITE	oak	anthracite		
						504	ROVERE GREY	ANTRACITE	grey oak	anthracite		
						506	ARGENTO GOLF	ANTRACITE	golf silver	anthracite		
						511	GIALLO FRESIA	ANTRACITE	freesia yellow	anthracite		
						521	ACERO TAKI	ANTRACITE	taki maple	anthracite		
						532	AZZURRO SKY	ANTRACITE	sky blue	anthracite		
						533	AMARANTO	ANTRACITE	amaranth	anthracite		
						541	BIANCO BR.	ANTRACITE	br. white	anthracite		
						544	STONE GREY	ANTRACITE	stone grey	anthracite		
						566	NOCE PAVIA	ANTRACITE	pavia walnut	anthracite		
						591	WENGÈ	ANTRACITE	wengè	anthracite		
						596	VERDE BOSCO	ANTRACITE	wood green	anthracite		
						803	ROVERE	STONE GREY	oak	stone grey		
						804	ROVERE GREY	STONE GREY	grey oak	stone grey		
						805	ARGENTO GOLF	STONE GREY	golf silver	stone grey		
						811	GIALLO FRESIA	STONE GREY	freesia yellow	stone grey		
						820	ACERO TAKI	STONE GREY	taki maple	stone grey		
						832	AZZURRO SKY	STONE GREY	sky blue	stone grey		
						833	AMARANTO	STONE GREY	amaranth	stone grey		
						840	BIANCO BR.	STONE GREY	br. white	stone grey		
						851	ANTRACITE	STONE GREY	anthracite	stone grey		
						866	NOCE PAVIA	STONE GREY	pavia walnut	stone grey		
						890	WENGÈ	STONE GREY	wengè	stone grey		
						896	VERDE BOSCO	STONE GREY	wood green	stone grey		
L.100 x p.60 x H.61,5												
MOBILE DI SERVIZIO L.100 CENTRALE CON CASSETTI E PORTA-CPU BIFACCIALI central service unit w 100 cms with drawers and CPU-holder in double-sides   ( Fig.SX/left )	CASSETTI IN LEGNO wooden drawers		CON CHIUSURA AMMORTIZZATA with soft-close			CASSETTI IN LEGNO wooden drawers			CON CHIUSURA AMMORTIZZATA with soft-close			
		152 786 (*)	40	0,281	3	€ 369,00	ABBINAMENTO A: for combining with:			COMPLETARE SEMPRE CON: always complete with:		
	ABBINAMENTO A: for combining with:	FUNZIONE: function:	COMPLETARE SEMPRE CON: always complete with:			1- BENCH	FREE-STANDING					
	2- SYSTEM	FREE-STANDING										
L.100 x p.60 x H.61,5												

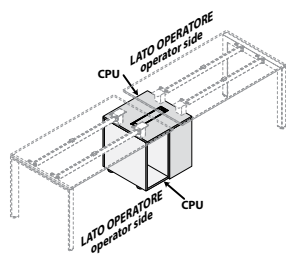
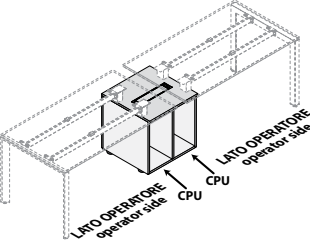
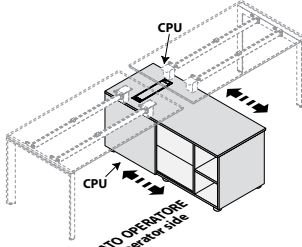

MOBILI DI SERVIZIO E PORTA-CPU service units and CPU-holder					UTILIZZABILI SU BENCH E SYSTEM usable for combining with BENCH and SYSTEM				
DESCRIZIONE <i>description</i>	CODICE <i>code</i>	KG	M <sup>3</sup>	COLLI	PREZZO <i>price</i>	(*) CODICE FINITURA <i>(*) finish code</i>			
PORTA-CPU CENTRALE PER POSTAZIONI CONTRAPPOSTE <i>central CPU-holder for 2 opposite stationing</i>    L.60 x p.60 x H.61,5	<b>152 458 (*)</b>	31	0,064	1	€ 125,00	VERSIONE MONO-COLORE / <i>single-color version</i>			
						(*)			
	ABBINAMENTO A: <i>for combining with:</i> FUNZIONE: <i>functions:</i> 1- BENCH		SOSTEGNO SOTTOPIANO <i>undertop support</i>		COMPLETARE SEMPRE CON: <i>always complete with:</i>				
PORTA-CPU CENTRALE PER POSTAZIONI AFFIANCATE <i>central CPU-holder for 2 side by side stationing</i>    L.60 x p.60 x H.61,5	<b>152 468 (*)</b>	31	0,064	1	€ 116,00	VERSIONE BI-COLORE / <i>double-color version</i>			
						(*)	FRONTALI + SCHIENA + TOP	STRUTTURA	fronts + back panel + top
		ABBINAMENTO A: <i>for combining with:</i> FUNZIONE: <i>functions:</i> 1- BENCH		SOSTEGNO SOTTOPIANO <i>undertop support</i>		COMPLETARE SEMPRE CON: <i>always complete with:</i>			
MOBILE DI SERVIZIO L.140 CENTRALE CON ANTINE SCORREVOLI E PORTA-CPU BIFACCIALI + VANO A GIORNO <i>central service unit w 140 cms with sliding doors and CPU-holder in double-sides + open glove compartment</i>    L.140 x p.60 x H.61,5	<b>152 602 (*)</b>	54	0,163	2	€ 357,00	ROVERE	ARGENTO GOLF	oak	golf silver
						ROVERE GREY	ARGENTO GOLF	grey oak	golf silver
		ABBINAMENTO A: <i>for combining with:</i> FUNZIONE: <i>functions:</i> 1- BENCH 2- SYSTEM		SOSTEGNO SOTTOPIANO <i>undertop support</i>  FREE-STANDING		COMPLETARE SEMPRE CON: <i>always complete with:</i>			

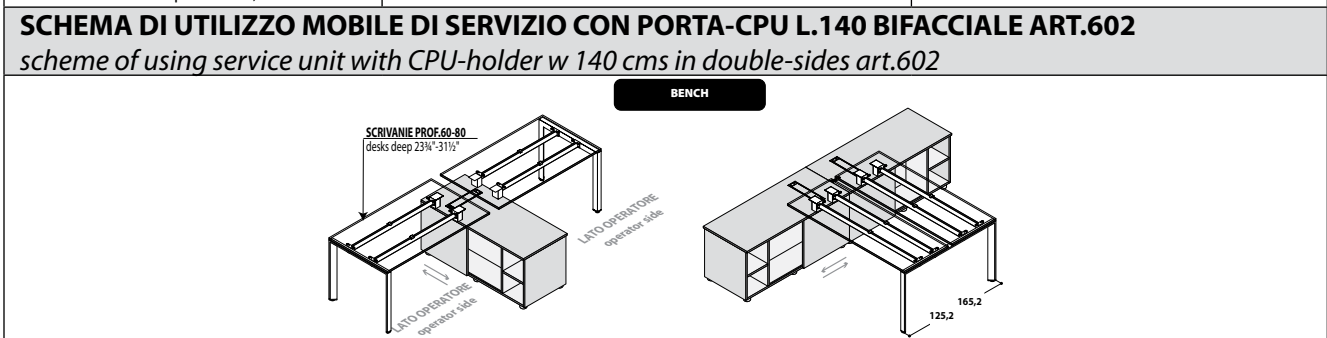

CLASSIFICATORE FREE-STANDING <i>free-standing file pedestal</i>						UTILIZZABILI SU BENCH E SYSTEM <i>usable for combining with BENCH and SYSTEM</i>		
DESCRIZIONE <i>description</i>	CODICE <i>code</i>	KG	M <sup>3</sup>	COLLI	PREZZO <i>price</i>	(*) CODICE FINITURA <i>(*) finish code</i>		
CLASSIFICATORE FREE-STANDING CON SERRATURA <i>free-standing file-pedestal with lock</i>	CASSETTO IN LEGNO <i>wooden drawers</i>		CON CHIUSURA AMMORTIZZATA <i>with soft-close</i>		23	0,232	1	€ 204,00
	152	769 (*)						
L.42 x p.60 x H.61,5	VERSIONE MONO-COLORE / <i>single-color version</i>							
	(*)							
000	ARGENTO GOLF	golf silver						
400	BIANCO BR.	br. white						
551	ANTRACITE	anthracite						
844	STONE GREY	stone grey						
	VERSIONE BI-COLORE / <i>double-color version</i>							
	(*)	FRONTALI + SCHIENA + TOP	STRUTTURA	fronts + back panel + top	structure			
003	ROVERE	ARGENTO GOLF	oak	golf silver				
004	ROVERE GREY	ARGENTO GOLF	grey oak	golf silver				
011	GIALLO FRESIA	ARGENTO GOLF	freesia yellow	golf silver				
020	ACERO TAKI	ARGENTO GOLF	taki maple	golf silver				
032	AZZURRO SKY	ARGENTO GOLF	sky blue	golf silver				
033	AMARANTO	ARGENTO GOLF	amaranth	golf silver				
040	BIANCO BR.	ARGENTO GOLF	br. white	golf silver				
044	STONE GREY	ARGENTO GOLF	stone grey	golf silver				
051	ANTRACITE	ARGENTO GOLF	anthracite	golf silver				
066	NOCE PAVIA	ARGENTO GOLF	pavia walnut	golf silver				
090	WENGÈ	ARGENTO GOLF	wengè	golf silver				
096	VERDE BOSCO	ARGENTO GOLF	wood green	golf silver				
403	ROVERE	BIANCO BR.	oak	br. white				
404	ROVERE GREY	BIANCO BR.	grey oak	br. white				
405	ARGENTO GOLF	BIANCO BR.	golf silver	br. white				
411	GIALLO FRESIA	BIANCO BR.	freesia yellow	br. white				
420	ACERO TAKI	BIANCO BR.	taki maple	br. white				
432	AZZURRO SKY	BIANCO BR.	sky blue	br. white				
433	AMARANTO	BIANCO BR.	amaranth	br. white				
444	STONE GREY	BIANCO BR.	stone grey	br. white				
451	ANTRACITE	BIANCO BR.	anthracite	br. white				
466	NOCE PAVIA	BIANCO BR.	pavia walnut	br. white				
490	WENGÈ	BIANCO BR.	wengè	br. white				
496	VERDE BOSCO	BIANCO BR.	wood green	br. white				
503	ROVERE	ANTRACITE	oak	anthracite				
504	ROVERE GREY	ANTRACITE	grey oak	anthracite				
506	ARGENTO GOLF	ANTRACITE	golf silver	anthracite				
511	GIALLO FRESIA	ANTRACITE	freesia yellow	anthracite				
521	ACERO TAKI	ANTRACITE	taki maple	anthracite				
532	AZZURRO SKY	ANTRACITE	sky blue	anthracite				
533	AMARANTO	ANTRACITE	amaranth	anthracite				
541	BIANCO BR.	ANTRACITE	br. white	anthracite				
544	STONE GREY	ANTRACITE	stone grey	anthracite				
566	NOCE PAVIA	ANTRACITE	pavia walnut	anthracite				
591	WENGÈ	ANTRACITE	wengè	anthracite				
596	VERDE BOSCO	ANTRACITE	wood green	anthracite				
803	ROVERE	STONE GREY	oak	stone grey				
804	ROVERE GREY	STONE GREY	grey oak	stone grey				
805	ARGENTO GOLF	STONE GREY	golf silver	stone grey				
811	GIALLO FRESIA	STONE GREY	freesia yellow	stone grey				
820	ACERO TAKI	STONE GREY	taki maple	stone grey				
832	AZZURRO SKY	STONE GREY	sky blue	stone grey				
833	AMARANTO	STONE GREY	amaranth	stone grey				
840	BIANCO BR.	STONE GREY	br. white	stone grey				
851	ANTRACITE	STONE GREY	anthracite	stone grey				
866	NOCE PAVIA	STONE GREY	pavia walnut	stone grey				
890	WENGÈ	STONE GREY	wengè	stone grey				
896	VERDE BOSCO	STONE GREY	wood green	stone grey				

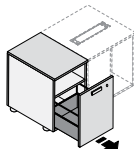

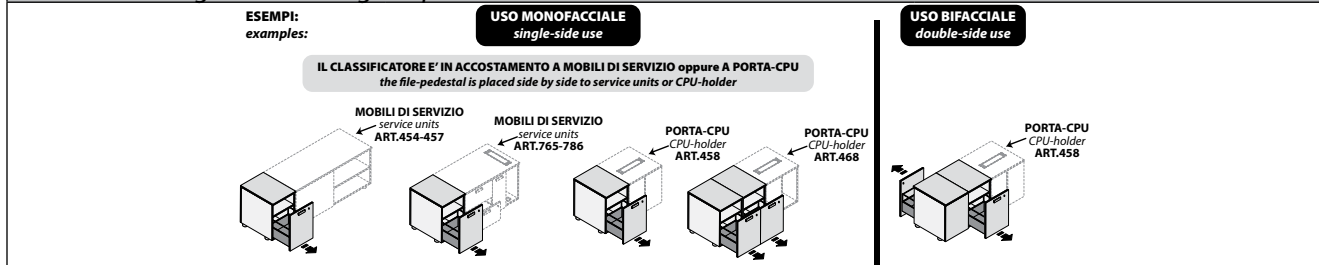

**SCHEMA DI UTILIZZO CLASSIFICATORE FREE-STANDING ART.469-769**  
*schema of using free-standing file-pedestal art.469-769*



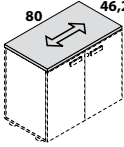
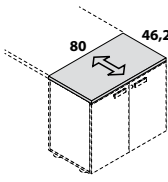
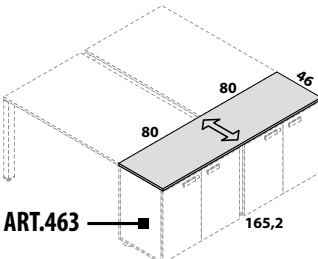

TOP PER CONTENITORE BASSO L.80																																					
top for low cabinet w 80 cms																																					
DESCRIZIONE description	L w	CODICE code	KG	M <sup>3</sup>	COLLI	PREZZO price	(*) CODICE FINITURA (*) finish code																														
TOP PER MOBILE SOTTOPIANO top for undertop cabinets    L.80 x p.46,2 x H.2,5		PIANO sp. 25mm top thick. 25mm																																			
	L.80	152 <b>422</b> (*)	10	0,019	1	€ 31,00																															
							<table border="1"> <thead> <tr> <th>(*)</th> <th>TOP</th> <th>top</th> </tr> </thead> <tbody> <tr> <td>166</td> <td>NOCE PAVIA</td> <td>pavia walnut</td> </tr> <tr> <td>200</td> <td>ACERO TAKI</td> <td>taki maple</td> </tr> <tr> <td>400</td> <td>BIANCO BR.</td> <td>br. white</td> </tr> <tr> <td>704</td> <td>ROVERE GREY</td> <td>grey oak</td> </tr> <tr> <td>733</td> <td>ROVERE</td> <td>oak</td> </tr> <tr> <td>844</td> <td>STONE GREY</td> <td>stone grey</td> </tr> <tr> <td>900</td> <td>WENGE'</td> <td>wenge</td> </tr> </tbody> </table>	(*)	TOP	top	166	NOCE PAVIA	pavia walnut	200	ACERO TAKI	taki maple	400	BIANCO BR.	br. white	704	ROVERE GREY	grey oak	733	ROVERE	oak	844	STONE GREY	stone grey	900	WENGE'	wenge						
(*)	TOP	top																																			
166	NOCE PAVIA	pavia walnut																																			
200	ACERO TAKI	taki maple																																			
400	BIANCO BR.	br. white																																			
704	ROVERE GREY	grey oak																																			
733	ROVERE	oak																																			
844	STONE GREY	stone grey																																			
900	WENGE'	wenge																																			
TOP PER MOBILE SOTTOPIANO top for undertop cabinets    L.80 x p.46,2 x H.		PIANO sp. 18mm top thick. 18mm																																			
	L.80	153 <b>639</b> (*)	10	0,019	1	€ 28,00																															
		PIANO sp. 25mm top thick. 25mm																																			
L.80	152 <b>425</b> (*)	10	0,019	1	€ 31,00																																
TOP PER 2 MOBILI LATERALI top for 2 lateral cabinets    L.46 x p.165,2 x H.		PIANO sp. 18mm top thick. 18mm																																			
	L.46	153 <b>876</b> (*)	16	0,042	1	€ 45,00																															
		PIANO sp. 25mm top thick. 25mm																																			
L.46	152 <b>276</b> (*)	14	0,042	1	€ 53,00																																
							<table border="1"> <thead> <tr> <th>(*)</th> <th>TOP</th> <th>top</th> </tr> </thead> <tbody> <tr> <td>000</td> <td>ARGENTO GOLF</td> <td>golf silver</td> </tr> <tr> <td>166</td> <td>NOCE PAVIA</td> <td>pavia walnut</td> </tr> <tr> <td>200</td> <td>ACERO TAKI</td> <td>taki maple</td> </tr> <tr> <td>400</td> <td>BIANCO BR.</td> <td>br. white</td> </tr> <tr> <td>551</td> <td>ANTRACITE</td> <td>anthracite</td> </tr> <tr> <td>704</td> <td>ROVERE GREY</td> <td>grey oak</td> </tr> <tr> <td>733</td> <td>ROVERE</td> <td>oak</td> </tr> <tr> <td>844</td> <td>STONE GREY</td> <td>stone grey</td> </tr> <tr> <td>900</td> <td>WENGE'</td> <td>wenge</td> </tr> </tbody> </table>	(*)	TOP	top	000	ARGENTO GOLF	golf silver	166	NOCE PAVIA	pavia walnut	200	ACERO TAKI	taki maple	400	BIANCO BR.	br. white	551	ANTRACITE	anthracite	704	ROVERE GREY	grey oak	733	ROVERE	oak	844	STONE GREY	stone grey	900	WENGE'	wenge
(*)	TOP	top																																			
000	ARGENTO GOLF	golf silver																																			
166	NOCE PAVIA	pavia walnut																																			
200	ACERO TAKI	taki maple																																			
400	BIANCO BR.	br. white																																			
551	ANTRACITE	anthracite																																			
704	ROVERE GREY	grey oak																																			
733	ROVERE	oak																																			
844	STONE GREY	stone grey																																			
900	WENGE'	wenge																																			

**CASSETTIERE SU RUOTE***mobile pedestals*

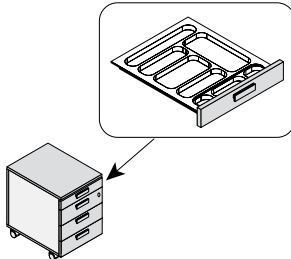
DESCRIZIONE <i>description</i>	CODICE <i>code</i>	KG	M <sup>3</sup>	COLLI	PREZZO <i>price</i>	(*) CODICE FINITURA <i>(*) finish code</i>				
CASSETTIERA SU RUOTE 3 CASSETTI (CON SERRATURA) <i>mobile pedestal with 3 drawers (with lock)</i>    L.42,1 x p.55,2 x H.57,3	<b>CASSETTI IN LEGNO</b> <i>wooden drawers</i>		<b>CON CHIUSURA AMMORTIZZATA</b> <i>with soft-close</i>			152 <b>780 (*)</b> 24    0,152    1    € <b>204,00</b>	VERSIONE MONO-COLORE / <i>single-color version</i>			
	<b>CASSETTI IN METALLO</b> <i>metal drawers</i>		<b>CON CHIUSURA AMMORTIZZATA</b> <i>with soft-close</i>				152 <b>781 (*)</b> 26    0,152    1    € <b>341,00</b>	(*)		
								000	ARGENTO GOLF	<i>golf silver</i>
						400	BIANCO BR.	<i>br. white</i>		
						551	ANTRACITE	<i>anthracite</i>		
						611	GIALLO FRESIA	<i>freesia yellow</i>		
						632	AZZURRO SKY	<i>sky blue</i>		
						633	AMARANTO	<i>amaranth</i>		
						696	VERDE BOSCO	<i>wood green</i>		
						844	STONE GREY	<i>stone grey</i>		
						VERSIONE BI-COLORE / <i>double-color version</i>		(*)		
						003	ROVERE	ARGENTO GOLF	<i>oak</i>	<i>golf silver</i>
						004	ROVERE GREY	ARGENTO GOLF	<i>grey oak</i>	<i>golf silver</i>
						011	GIALLO FRESIA	ARGENTO GOLF	<i>freesia yellow</i>	<i>golf silver</i>
						020	ACERO TAKI	ARGENTO GOLF	<i>taki maple</i>	<i>golf silver</i>
					032	AZZURRO SKY	ARGENTO GOLF	<i>sky blue</i>	<i>golf silver</i>	
					033	AMARANTO	ARGENTO GOLF	<i>amaranth</i>	<i>golf silver</i>	
					040	BIANCO BR.	ARGENTO GOLF	<i>br. white</i>	<i>golf silver</i>	
					044	STONE GREY	ARGENTO GOLF	<i>stone grey</i>	<i>golf silver</i>	
					051	ANTRACITE	ARGENTO GOLF	<i>anthracite</i>	<i>golf silver</i>	
					066	NOCE PAVIA	ARGENTO GOLF	<i>pavia walnut</i>	<i>golf silver</i>	
					090	WENGÈ	ARGENTO GOLF	<i>wengè</i>	<i>golf silver</i>	
					096	VERDE BOSCO	ARGENTO GOLF	<i>wood green</i>	<i>golf silver</i>	
					403	ROVERE	BIANCO BR.	<i>oak</i>	<i>br. white</i>	
					404	ROVERE GREY	BIANCO BR.	<i>grey oak</i>	<i>br. white</i>	
					405	ARGENTO GOLF	BIANCO BR.	<i>golf silver</i>	<i>br. white</i>	
					411	GIALLO FRESIA	BIANCO BR.	<i>freesia yellow</i>	<i>br. white</i>	
					420	ACERO TAKI	BIANCO BR.	<i>taki maple</i>	<i>br. white</i>	
					432	AZZURRO SKY	BIANCO BR.	<i>sky blue</i>	<i>br. white</i>	
					433	AMARANTO	BIANCO BR.	<i>amaranth</i>	<i>br. white</i>	
					444	STONE GREY	BIANCO BR.	<i>stone grey</i>	<i>br. white</i>	
					451	ANTRACITE	BIANCO BR.	<i>anthracite</i>	<i>br. white</i>	
					466	NOCE PAVIA	BIANCO BR.	<i>pavia walnut</i>	<i>br. white</i>	
					490	WENGÈ	BIANCO BR.	<i>wengè</i>	<i>br. white</i>	
					496	VERDE BOSCO	BIANCO BR.	<i>wood green</i>	<i>br. white</i>	
					503	ROVERE	ANTRACITE	<i>oak</i>	<i>anthracite</i>	
					504	ROVERE GREY	ANTRACITE	<i>grey oak</i>	<i>anthracite</i>	
					506	ARGENTO GOLF	ANTRACITE	<i>golf silver</i>	<i>anthracite</i>	
					511	GIALLO FRESIA	ANTRACITE	<i>freesia yellow</i>	<i>anthracite</i>	
					521	ACERO TAKI	ANTRACITE	<i>taki maple</i>	<i>anthracite</i>	
					532	AZZURRO SKY	ANTRACITE	<i>sky blue</i>	<i>anthracite</i>	
					533	AMARANTO	ANTRACITE	<i>amaranth</i>	<i>anthracite</i>	
					541	BIANCO BR.	ANTRACITE	<i>br. white</i>	<i>anthracite</i>	
					544	STONE GREY	ANTRACITE	<i>stone grey</i>	<i>anthracite</i>	
					566	NOCE PAVIA	ANTRACITE	<i>pavia walnut</i>	<i>anthracite</i>	
					591	WENGÈ	ANTRACITE	<i>wengè</i>	<i>anthracite</i>	
					596	VERDE BOSCO	ANTRACITE	<i>wood green</i>	<i>anthracite</i>	
					803	ROVERE	STONE GREY	<i>oak</i>	<i>stone grey</i>	
					804	ROVERE GREY	STONE GREY	<i>grey oak</i>	<i>stone grey</i>	
					805	ARGENTO GOLF	STONE GREY	<i>golf silver</i>	<i>stone grey</i>	
					811	GIALLO FRESIA	STONE GREY	<i>freesia yellow</i>	<i>stone grey</i>	
					820	ACERO TAKI	STONE GREY	<i>taki maple</i>	<i>stone grey</i>	
					832	AZZURRO SKY	STONE GREY	<i>sky blue</i>	<i>stone grey</i>	
					833	AMARANTO	STONE GREY	<i>amaranth</i>	<i>stone grey</i>	
					840	BIANCO BR.	STONE GREY	<i>br. white</i>	<i>stone grey</i>	
					851	ANTRACITE	STONE GREY	<i>anthracite</i>	<i>stone grey</i>	
					866	NOCE PAVIA	STONE GREY	<i>pavia walnut</i>	<i>stone grey</i>	
					890	WENGÈ	STONE GREY	<i>wengè</i>	<i>stone grey</i>	
					896	VERDE BOSCO	STONE GREY	<i>wood green</i>	<i>stone grey</i>	
CASSETTIERA-CLASSIFICATORE SU RUOTE (CON SERRATURA) <i>mobile pedestal with file-drawer (with lock)</i>    L.42,1 x p.55,2 x H.57,3		<b>CASSETTI IN LEGNO</b> <i>wooden drawers</i>		<b>CON CHIUSURA AMMORTIZZATA</b> <i>with soft-close</i>			152 <b>782 (*)</b> 23    0,152    1    € <b>226,00</b>			
		<b>CASSETTI IN METALLO</b> <i>metal drawers</i>		<b>CON CHIUSURA AMMORTIZZATA</b> <i>with soft-close</i>				152 <b>783 (*)</b> 25    0,152    1    € <b>333,00</b>		
CASSETTIERA SU RUOTE 3 CASSETTI+1 PORTA-CANCELLERIA (CON SERRATURA) <i>3 drawers pedestal +1 stationery-drawer on wheels (with lock)</i>    L.42,1 x p.55,2 x H.57,3		<b>CASSETTI IN LEGNO</b> <i>wooden drawers</i>		<b>CON CHIUSURA AMMORTIZZATA</b> <i>with soft-close</i>			152 <b>784 (*)</b> 24    0,152    1    € <b>247,00</b>			
		<b>CASSETTI IN METALLO</b> <i>metal drawers</i>		<b>CON CHIUSURA AMMORTIZZATA</b> <i>with soft-close</i>				152 <b>785 (*)</b> 26    0,152    1    € <b>384,00</b>		

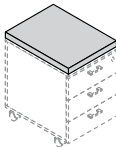
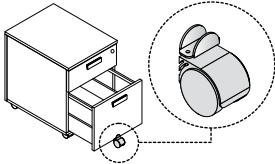
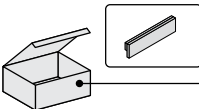

ACCESSORI PER CASSETTIERE SU RUOTE accessories for pedestals on wheels									
DESCRIZIONE description	L w	CODICE code	KG	M <sup>3</sup>	COLLI	PREZZO price	(*) CODICE FINITURA (*) finish code		
<p>CUSCINO PER CASSETTIERE SU RUOTE cushion for pedestals on wheels</p>  <p>L.42,1 x p.55,2 x H.3</p>		114 <b>956</b> (*)	2	0,020	1	€ 51,00	(*) TESSUTO POLIESTERE STRETCH IGNIFUGO	fire-retardant stretch polyester fabric	
							320	AZZURRO SKY	sky blue
							321	GIALLO FRESIA	freesia yellow
							322	AMARANTO	amaranth
							323	VERDE BOSCO	wood green
							327	GRIGIO	grey
							328	TORTORA	grey beige
							330	MATONE	brick red
							331	ARANCIO	orange
							332	ROSSO	red
							333	VERDE ACIDO	acid green
							334	BLU	blue
							<p>5a RUOTA OPZIONALE PER CASSETTIERA CLASSIFICATORE fifth optional wheels for file-pedestal</p> 		175 <b>105</b> (*)
300	ARGENTO METALLIZZATO metallic silver	GRIGIA grey							
<p>KIT 6 MANIGLIE set of 6 handles</p>  <p><b>6 PEZZI</b> 6 pieces</p> <p>L.12 x p.1 x H.3</p>		152 <b>358</b> (*)	1,5	0,001	1	€ 38,00	(*)		
							000	ARGENTO	silver
							166	NOCE PAVIA	pavia walnut
							200	ACERO TAKI	taki maple
							400	BIANCO BR.	br. white
							551	ANTRACITE	anthracite
							611	GIALLO FRESIA	freesia yellow
							632	AZZURRO SKY	sky blue
							633	AMARANTO	amaranth
							696	VERDE BOSCO	wood green
							704	ROVERE GREY	grey oak
							733	ROVERE	oak
							844	STONE GREY	stone grey
900	WENGE'	wenge							





### TOP PER CASSETTIERE-BASI

top for base-pedestals

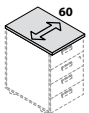
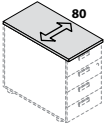
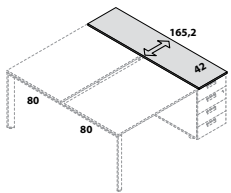
DESCRIZIONE description	L w	CODICE code	KG	M <sup>3</sup>	COLLI	PREZZO price	(*) CODICE FINITURA (*) finish code																														
TOP PER CASSETTIERA PROF. CM 60 top for pedestal deep 60 cms    L.42 x p.60 x H.		PIANO sp. 18mm top thick. 18mm L42 <b>153 871 (*)</b>	3	0,014	1	<b>€ 18,00</b>																															
		PIANO sp. 25mm top thick. 25mm L42 <b>152 448 (*)</b>	3	0,014	1	<b>€ 21,00</b>																															
TOP PER CASSETTIERA PROF. CM 80 top for pedestal deep 80 cms    L.42 x p.80 x H.		PIANO sp. 18mm top thick. 18mm L42 <b>153 872 (*)</b>	4	0,017	1	<b>€ 23,00</b>	<table border="1"> <thead> <tr> <th>(*)</th> <th>TOP</th> <th>top</th> </tr> </thead> <tbody> <tr><td>000</td><td>ARGENTO GOLF</td><td>golf silver</td></tr> <tr><td>166</td><td>NOCE PAVIA</td><td>pavia walnut</td></tr> <tr><td>200</td><td>ACERO TAKI</td><td>taki maple</td></tr> <tr><td>400</td><td>BIANCO BR.</td><td>br. white</td></tr> <tr><td>551</td><td>ANTRACITE</td><td>anthracite</td></tr> <tr><td>704</td><td>ROVERE GREY</td><td>grey oak</td></tr> <tr><td>733</td><td>ROVERE</td><td>oak</td></tr> <tr><td>844</td><td>STONE GREY</td><td>stone grey</td></tr> <tr><td>900</td><td>WENGE'</td><td>wenge</td></tr> </tbody> </table>	(*)	TOP	top	000	ARGENTO GOLF	golf silver	166	NOCE PAVIA	pavia walnut	200	ACERO TAKI	taki maple	400	BIANCO BR.	br. white	551	ANTRACITE	anthracite	704	ROVERE GREY	grey oak	733	ROVERE	oak	844	STONE GREY	stone grey	900	WENGE'	wenge
	(*)	TOP	top																																		
000	ARGENTO GOLF	golf silver																																			
166	NOCE PAVIA	pavia walnut																																			
200	ACERO TAKI	taki maple																																			
400	BIANCO BR.	br. white																																			
551	ANTRACITE	anthracite																																			
704	ROVERE GREY	grey oak																																			
733	ROVERE	oak																																			
844	STONE GREY	stone grey																																			
900	WENGE'	wenge																																			
	PIANO sp. 25mm top thick. 25mm L42 <b>152 449 (*)</b>	6	0,017	1	<b>€ 28,00</b>																																
TOP PER 2 CASSETTIERE LATERALI O STORAGE PROF. CM 80 top for 2 lateral pedestals or storage deep 80 cms    L.42 x p.165,2 x H.		PIANO sp. 18mm top thick. 18mm L42 <b>153 874 (*)</b>	14	0,042	1	<b>€ 41,00</b>																															
		PIANO sp. 25mm top thick. 25mm L42 <b>152 274 (*)</b>	11	0,042	1	<b>€ 51,00</b>																															

### SCHEMA DI UTILIZZO CASSETTIERE-BASI, STORAGE O MOBILE BASSO L.80

schema of using pedestals, storage or low cabinete w 80 cms

#### BENCH

LE CASSETTIERE, STORAGE o MOBILE L.80 SONO IN ACCOSTAMENTO E DEVONO ESSERE COMPLETATI CON TOP DI FINITURA  
the pedestals, storage or cabinet w 80 cms are placed on the side and must be completed with top

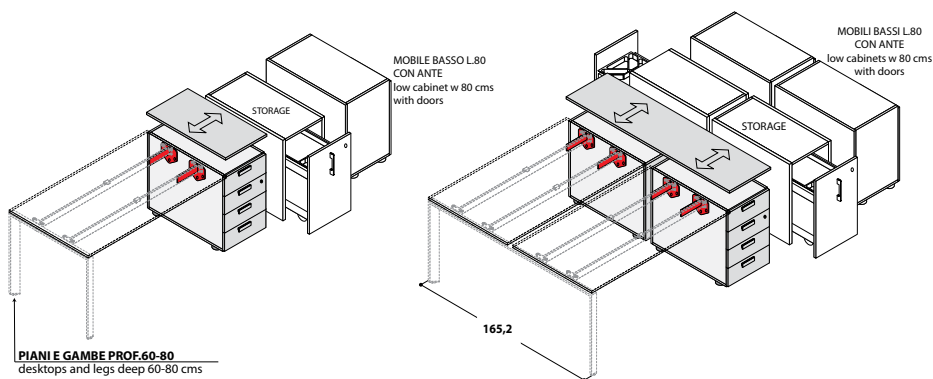



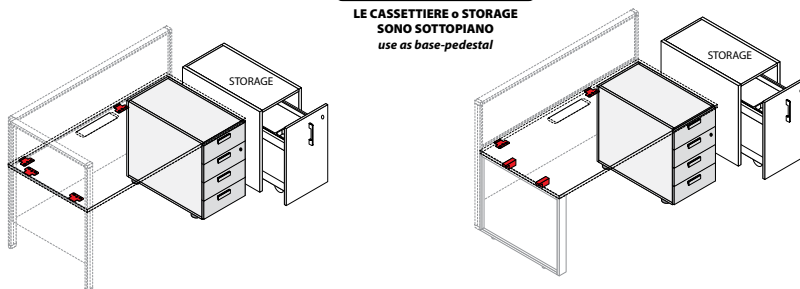

#### SYSTEM

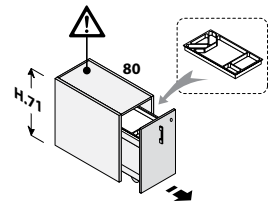
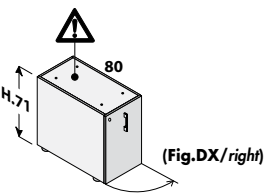
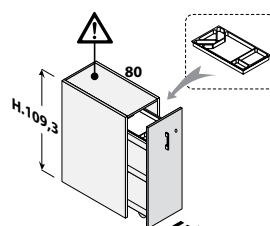
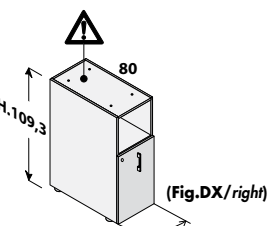
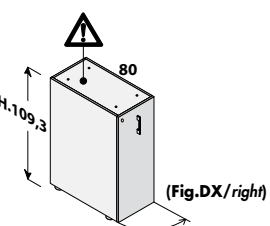

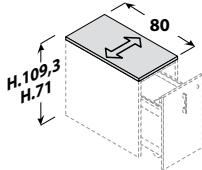
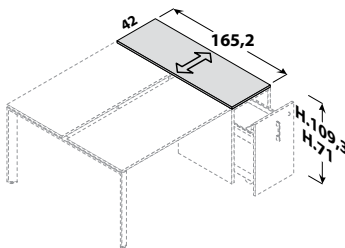
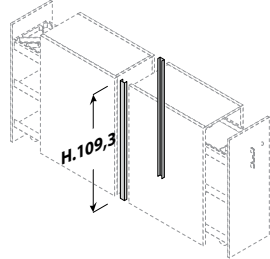

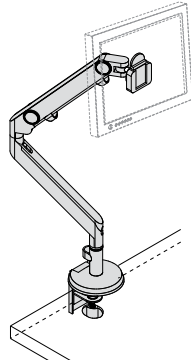
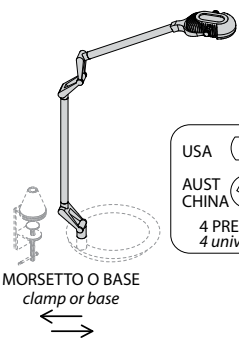



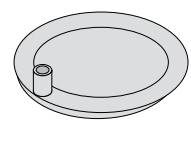
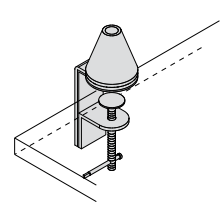
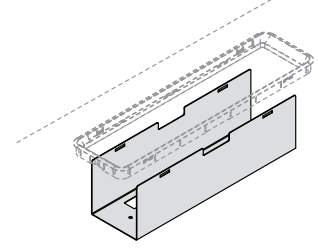



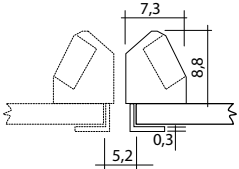
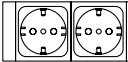

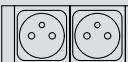





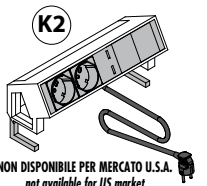
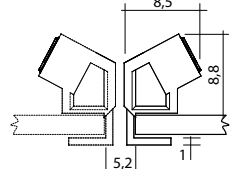
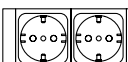

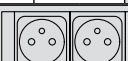
LE CASSETTIERE o STORAGE SONO SOTTOPIANO  
use as base-pedestal

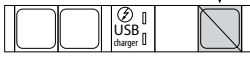

STORAGE STANDARD PER PIANI PROF. CM 80 standard storage for desktops deep 80 cms							
DESCRIZIONE description	L w	CODICE code	KG	M <sup>3</sup>	COLLI	PREZZO price	(*) CODICE FINITURA (* finish code)
STORAGE STANDARD H.71 (DOTATO DI VASCHETTA PORTA-CANCELLERIA) standard storage h.71 cms (with stationery tray)							
	L.42	152 441 (*)	43	0,157	5	€ 448,00	
L.42 x p.80 x H.71							
PER USO LATERALE COMPLETARE SEMPRE CON TOP DI FINITURA (VEDI PAGINA SEGUENTE) for lateral use always complete with finish top (please see next page)							
VERSIONE MONO-COLORE / single-color version							
	(*)						
	000	ARGENTO GOLF					golf silver
	400	BIANCO BR.					br. white
	551	ANTRACITE					anthracite
	844	STONE GREY					stone grey
STORAGE STANDARD H.71 CON ANTA CON SERRATURA standard storage h.71 cms with wooden door with lock							
	DX right L.42	152 616 (*)	33	0,114	3	€ 164,00	
	SX left L.42	152 617 (*)					
L.42 x p.80 x H.71							
PER USO LATERALE COMPLETARE SEMPRE CON TOP DI FINITURA (VEDI PAGINA SEGUENTE) for lateral use always complete with finish top (please see next page)							
VERSIONE BI-COLORE / double-color version							
	(*)	FRONTALI	STRUTTURA	fronts	structure		
	003	ROVERE	ARGENTO GOLF	oak	golf silver		
	004	ROVERE GREY	ARGENTO GOLF	grey oak	golf silver		
	011	GIALLO FRESIA	ARGENTO GOLF	freesia yellow	golf silver		
	020	ACERO TAKI	ARGENTO GOLF	taki maple	golf silver		
	032	AZZURRO SKY	ARGENTO GOLF	sky blue	golf silver		
	033	AMARANTO	ARGENTO GOLF	amaranth	golf silver		
	040	BIANCO BR.	ARGENTO GOLF	br. white	golf silver		
	044	STONE GREY	ARGENTO GOLF	stone grey	golf silver		
	051	ANTRACITE	ARGENTO GOLF	anthracite	golf silver		
	066	NOCE PAVIA	ARGENTO GOLF	pavia walnut	golf silver		
	090	WENGÈ	ARGENTO GOLF	wengè	golf silver		
	096	VERDE BOSCO	ARGENTO GOLF	wood green	golf silver		
STORAGE STANDARD H.109,3 (DOTATO DI VASCHETTA PORTA-CANCELLERIA) standard storage h.109,3 cms (with stationery tray)							
	L.42	152 443 (*)	64	0,226	5	€ 581,00	
L.42 x p.80 x H.109,3							
PER USO LATERALE COMPLETARE SEMPRE CON TOP DI FINITURA (VEDI PAGINA SEGUENTE) for lateral use always complete with finish top (please see next page)							
VERSIONE BI-COLORE / double-color version							
	(*)	FRONTALI	STRUTTURA	fronts	structure		
	403	ROVERE	BIANCO BR.	oak	br. white		
	404	ROVERE GREY	BIANCO BR.	grey oak	br. white		
	405	ARGENTO GOLF	BIANCO BR.	golf silver	br. white		
	411	GIALLO FRESIA	BIANCO BR.	freesia yellow	br. white		
	420	ACERO TAKI	BIANCO BR.	taki maple	br. white		
	432	AZZURRO SKY	BIANCO BR.	sky blue	br. white		
	433	AMARANTO	BIANCO BR.	amaranth	br. white		
	444	STONE GREY	BIANCO BR.	stone grey	br. white		
	451	ANTRACITE	BIANCO BR.	anthracite	br. white		
	466	NOCE PAVIA	BIANCO BR.	pavia walnut	br. white		
	490	WENGÈ	BIANCO BR.	wengè	br. white		
	496	VERDE BOSCO	BIANCO BR.	wood green	br. white		
	503	ROVERE	ANTRACITE	oak	anthracite		
	504	ROVERE GREY	ANTRACITE	grey oak	anthracite		
	506	ARGENTO GOLF	ANTRACITE	golf silver	anthracite		
	511	GIALLO FRESIA	ANTRACITE	freesia yellow	anthracite		
	521	ACERO TAKI	ANTRACITE	taki maple	anthracite		
	532	AZZURRO SKY	ANTRACITE	sky blue	anthracite		
	533	AMARANTO	ANTRACITE	amaranth	anthracite		
	541	BIANCO BR.	ANTRACITE	br. white	anthracite		
	544	STONE GREY	ANTRACITE	stone grey	anthracite		
	566	NOCE PAVIA	ANTRACITE	pavia walnut	anthracite		
	591	WENGÈ	ANTRACITE	wengè	anthracite		
	596	VERDE BOSCO	ANTRACITE	wood green	anthracite		
	803	ROVERE	STONE GREY	oak	stone grey		
	804	ROVERE GREY	STONE GREY	grey oak	stone grey		
	805	ARGENTO GOLF	STONE GREY	golf silver	stone grey		
	811	GIALLO FRESIA	STONE GREY	freesia yellow	stone grey		
	820	ACERO TAKI	STONE GREY	taki maple	stone grey		
	832	AZZURRO SKY	STONE GREY	sky blue	stone grey		
	833	AMARANTO	STONE GREY	amaranth	stone grey		
	840	BIANCO BR.	STONE GREY	br. white	stone grey		
	851	ANTRACITE	STONE GREY	anthracite	stone grey		
	866	NOCE PAVIA	STONE GREY	pavia walnut	stone grey		
	890	WENGÈ	STONE GREY	wengè	stone grey		
	896	VERDE BOSCO	STONE GREY	wood green	stone grey		
STORAGE STANDARD H.109,3 CON ANTA CON SERRATURA standard storage h.109,3 with wooden door with lock							
	DX right L.42	152 618 (*)	46	0,195	3	€ 221,00	
	SX left L.42	152 619 (*)					
L.42 x p.80 x H.109,3							
PER USO LATERALE COMPLETARE SEMPRE CON TOP DI FINITURA (VEDI PAGINA SEGUENTE) for lateral use always complete with finish top (please see next page)							
VERSIONE BI-COLORE / double-color version							
	(*)	FRONTALI	STRUTTURA	fronts	structure		
	803	ROVERE	STONE GREY	oak	stone grey		
	804	ROVERE GREY	STONE GREY	grey oak	stone grey		
	805	ARGENTO GOLF	STONE GREY	golf silver	stone grey		
	811	GIALLO FRESIA	STONE GREY	freesia yellow	stone grey		
	820	ACERO TAKI	STONE GREY	taki maple	stone grey		
	832	AZZURRO SKY	STONE GREY	sky blue	stone grey		
	833	AMARANTO	STONE GREY	amaranth	stone grey		
	840	BIANCO BR.	STONE GREY	br. white	stone grey		
	851	ANTRACITE	STONE GREY	anthracite	stone grey		
	866	NOCE PAVIA	STONE GREY	pavia walnut	stone grey		
	890	WENGÈ	STONE GREY	wengè	stone grey		
	896	VERDE BOSCO	STONE GREY	wood green	stone grey		
STORAGE STANDARD H.109,3 CON ANTA CON SERRATURA standard storage h.109,3 with wooden door with lock							
	DX right L.42	152 621 (*)	48	0,206	3	€ 229,00	
	SX left L.42	152 622 (*)					
L.42 x p.80 x H.109,3							
PER USO LATERALE COMPLETARE SEMPRE CON TOP DI FINITURA (VEDI PAGINA SEGUENTE) for lateral use always complete with finish top (please see next page)							
VERSIONE BI-COLORE / double-color version							
	(*)	FRONTALI	STRUTTURA	fronts	structure		
	803	ROVERE	STONE GREY	oak	stone grey		
	804	ROVERE GREY	STONE GREY	grey oak	stone grey		
	805	ARGENTO GOLF	STONE GREY	golf silver	stone grey		
	811	GIALLO FRESIA	STONE GREY	freesia yellow	stone grey		
	820	ACERO TAKI	STONE GREY	taki maple	stone grey		
	832	AZZURRO SKY	STONE GREY	sky blue	stone grey		
	833	AMARANTO	STONE GREY	amaranth	stone grey		
	840	BIANCO BR.	STONE GREY	br. white	stone grey		
	851	ANTRACITE	STONE GREY	anthracite	stone grey		
	866	NOCE PAVIA	STONE GREY	pavia walnut	stone grey		
	890	WENGÈ	STONE GREY	wengè	stone grey		
	896	VERDE BOSCO	STONE GREY	wood green	stone grey		

TOP PER STORAGE																																				
top for storage																																				
DESCRIZIONE description	P d	CODICE code	KG	M <sup>3</sup>	COLLI	PREZZO price	(*) CODICE FINITURA (*) finish code																													
<p>TOP SINGOLO single top</p>  <p>L.42 x p. x H.</p>		<p>PIANO sp. 18mm top thick. 18mm</p> <p>p.80 <b>153 872 (*)</b></p>	4	0,017	1	<b>€ 23,00</b>																														
		<p>PIANO sp. 25mm top thick. 25mm</p> <p>p.80 <b>152 449 (*)</b></p>	6	0,017	1	<b>€ 28,00</b>	<table border="1"> <thead> <tr> <th>(*)</th> <th>TOP</th> <th>top</th> </tr> </thead> <tbody> <tr> <td>000</td> <td>ARGENTO GOLF</td> <td>golf silver</td> </tr> <tr> <td>166</td> <td>NOCE PAVIA</td> <td>pavia walnut</td> </tr> <tr> <td>200</td> <td>ACERO TAKI</td> <td>taki maple</td> </tr> <tr> <td>400</td> <td>BIANCO BR.</td> <td>br. white</td> </tr> <tr> <td>551</td> <td>ANTRACITE</td> <td>anthracite</td> </tr> <tr> <td>704</td> <td>ROVERE GREY</td> <td>grey oak</td> </tr> <tr> <td>733</td> <td>ROVERE</td> <td>oak</td> </tr> <tr> <td>844</td> <td>STONE GREY</td> <td>stone grey</td> </tr> <tr> <td>900</td> <td>WENGE'</td> <td>wenge</td> </tr> </tbody> </table>	(*)	TOP	top	000	ARGENTO GOLF	golf silver	166	NOCE PAVIA	pavia walnut	200	ACERO TAKI	taki maple	400	BIANCO BR.	br. white	551	ANTRACITE	anthracite	704	ROVERE GREY	grey oak	733	ROVERE	oak	844	STONE GREY	stone grey	900	WENGE'
(*)	TOP	top																																		
000	ARGENTO GOLF	golf silver																																		
166	NOCE PAVIA	pavia walnut																																		
200	ACERO TAKI	taki maple																																		
400	BIANCO BR.	br. white																																		
551	ANTRACITE	anthracite																																		
704	ROVERE GREY	grey oak																																		
733	ROVERE	oak																																		
844	STONE GREY	stone grey																																		
900	WENGE'	wenge																																		
<p>TOP PER 2 STORAGE top for 2 storage</p>  <p>L.42 x p. x H.</p>		<p>PIANO sp. 18mm top thick. 18mm</p> <p>p.165,2 <b>153 874 (*)</b></p>	14	0,042	1	<b>€ 41,00</b>																														
		<p>PIANO sp. 25mm top thick. 25mm</p> <p>p.165,2 <b>152 274 (*)</b></p>	11	0,042	1	<b>€ 51,00</b>																														
<p>2 COPERTURE LATERALI PER STORAGE 2 side covers for storage</p>  <p>L.5,2 x p.5,2 x H.109,3</p>		<b>152 450 (*)</b>	4	0,007	1	<b>€ 85,00</b>	<table border="1"> <thead> <tr> <th>(*)</th> <th>TOP</th> <th>top</th> </tr> </thead> <tbody> <tr> <td>000</td> <td>ARGENTO</td> <td>silver</td> </tr> <tr> <td>400</td> <td>BIANCO</td> <td>white</td> </tr> <tr> <td>551</td> <td>ANTRACITE</td> <td>anthracite</td> </tr> <tr> <td>844</td> <td>STONE GREY</td> <td>stone grey</td> </tr> </tbody> </table>	(*)	TOP	top	000	ARGENTO	silver	400	BIANCO	white	551	ANTRACITE	anthracite	844	STONE GREY	stone grey														
	(*)	TOP	top																																	
000	ARGENTO	silver																																		
400	BIANCO	white																																		
551	ANTRACITE	anthracite																																		
844	STONE GREY	stone grey																																		

ACCESSORI accessories								
DESCRIZIONE description	L w	CODICE code	KG	M <sup>3</sup>	COLLI	PREZZO price	(*) CODICE FINITURA (*) finish code	
BRACCIO SNODATO PORTA-VIDEO CON MORSETTO PER ANCORAGGIO A PIANI DI LAVORO (PORTATA MAX. KG 9- DIMENSIONI DA 15" A 23") <i>articulated rotating video stand arm+clamp            for fixing to work tops (max capacity Kg 9- sizes 15"-23")</i> 		152 <b>362</b> (*)	3	0,006	1	€ 263,00		
LAMPADA A LED - 5 Watt (con 4 prese universali intercambiabili) <i>led lamp - 5 Watt (4 interchangeable plugs)</i>  <div style="border: 1px solid black; padding: 5px; width: fit-content; margin: 10px auto;">             USA  EU               AUST  CHINA               4 PRESE UNIVERSALI              4 universal plugs           </div> <p>MORSETTO O BASE clamp or base</p>		153 <b>753</b> (*)	0,8	0,002	1	€ 387,00		
	<b>COMPLETARE SEMPRE CON BASE ART.349 OPPURE MORSETTO ART.361</b> <i>always complete with base art.349 or clamp art.361</i>							(*)
								000 ARGENTO silver
BASE PER LAMPADA ART.753 <i>base for lamp art.753</i>  <p>Ø 23</p>		152 <b>349</b> (*)	1	0,002	1	€ 55,00		
MORSETTO PER ANCORAGGIO LAMPADA ART.753 A PIANI DI LAVORO <i>clamp for fixing lamp art.753 to work tops</i> 		152 <b>361</b> (*)	0,5	0,002	1	€ 38,00		
VASCHETTA PASSA-CAVI PER TOP ACCESS <i>cable-tray for top access</i>  <p>L.22 x p.9,7 x H.10</p>		152 <b>348</b> (*)	1	0,012	1	€ 29,00	(*)	
							000 ARGENTO silver	
							400 BIANCO white	
							551 ANTRACITE anthracite	
							844 STONE GREY stone grey	

<b>KIT ELETRIFICAZIONE tipo K1 (BACHMANN )</b> <i>electrification kit type K1 (by Bachmann)</i>									
DESCRIZIONE <i>description</i>	L <i>w</i>	CODICE <i>code</i>	KG	M <sup>3</sup>	COLLI	PREZZO <i>price</i>	(*) CODICE FINITURA <i>(*) finish code</i>		
<p>1 KIT ELETRIFICAZIONE ORIZZONTALE CON MORSETTO PER FISSAGGIO A SCRIVANIA (CON CAVO DI ALIMENTAZIONE MT. 2,00 E PRESE STANDARD) CON 1 MODULO PERSONALIZZABILE OPTIONAL 1 electrification kit with fixing clamp on desktop (power cable of w 2 lmt. and standard sockets) with 1 customizable module (OPTIONAL)</p>  <p><b>NON DISPONIBILE PER MERCATO U.S.A.</b> <i>not available for US market</i></p>  <p>L.28,1 x p.7,3 x H.8,8</p>		<b>175 117 (*)</b>	1,5	0,010	<b>2</b>	<b>€ 257,00</b>			
		  	<b>2 PRESE STANDARD ITALIA GERMANIA(SCHUKO)+2 CHARGER USB+1 TAPPO</b> <i>2 Italia/Germany standard sockets+ 2 charger USB+ 1 cap</i>						
		<b>175 118 (*)</b>	1,5	0,010	<b>2</b>	<b>€ 243,00</b>			
		  	<b>2 PRESE STANDARD FRANCIA+2 CHARGER USB +1 TAPPO</b> <i>2 France standard sockets + 2 charger USB + 1 cap</i>						
		<b>175 119 (*)</b>	1,5	0,010	<b>2</b>	<b>€ 270,00</b>			
	  	<b>2 PRESE STANDARD INGLESI+2 CHARGER USB +1 TAPPO</b> <i>2 BRITISH standard sockets + 2 charger USB +1 cap</i>							
							(*)		
		<b>000</b>					ARGENTO		<i>silver</i>
<b>KIT ELETRIFICAZIONE tipo K2 (BACHMANN )</b> <i>electrification kit type K2 (by Bachmann)</i>									
<p>1 KIT ELETRIFICAZIONE ORIZZONTALE CON MORSETTO PER FISSAGGIO A SCRIVANIA (CON CAVO DI ALIMENTAZIONE MT. 2,00 E PRESE STANDARD) CON 1 MODULO PERSONALIZZABILE OPTIONAL 1 electrification kit with fixing clamp on desktop (power cable of w 2 lmt. and standard sockets) with 1 customizable module (OPTIONAL)</p>  <p><b>NON DISPONIBILE PER MERCATO U.S.A.</b> <i>not available for US market</i></p>  <p>L.28,1 x p.8,5 x H.8,8</p>		<b>175 120 (*)</b>	1,5	0,010	<b>2</b>	<b>€ 317,00</b>			
		  	<b>2 PRESE STANDARD ITALIA GERMANIA(SCHUKO)+2 CHARGER USB +1 TAPPO</b> <i>2 Italia/Germany standard sockets + 2 charger USB + 1 cap</i>						
		<b>175 121 (*)</b>	1,5	0,010	<b>2</b>	<b>€ 285,00</b>			
		  	<b>2 PRESE STANDARD FRANCIA+2 CHARGER USB +1 TAPPO</b> <i>2 France standard sockets + 2 charger USB + 1 cap</i>						
		<b>175 122 (*)</b>	1,5	0,010	<b>2</b>	<b>€ 343,00</b>			
	  	<b>2 PRESE STANDARD INGLESI+2 CHARGER USB +1 TAPPO</b> <i>2 BRITISH standard sockets + 2 charger USB +1 cap</i>							
							(*)		
		<b>450</b>					BIANCO		<i>white</i>
		<b>500</b>					NERO		<i>black</i>
<b>MODULI PERSONALIZZABILI (BACHMANN )</b> <i>customizable modules (by Bachmann)</i>									
<p>1 MODULO PERSONALIZZABILE 1 customizable module</p> <p>RIMUOVERE IL TAPPO IN DOTAZIONE E INSERIRE QUI REMOVE THE CAP AND INSERT HERE</p>  <p>L.4,5 x H.4,5</p>		 <b>1 RJ45 CAT.6</b>	<b>175 123 (*)</b>	0,5	0,001	<b>1</b>	<b>€ 39,00</b>		
		 <b>2 RJ45 CAT.6</b>	<b>175 124 (*)</b>	0,5	0,001	<b>1</b>	<b>€ 73,00</b>		
		 <b>1 RJ45 CAT.6</b> <b>1 HDMI</b>	<b>175 125 (*)</b>	0,5	0,001	<b>1</b>	<b>€ 73,00</b>		
								(*)	
		<b>500</b>					NERO		<i>black</i>

**SCHEMA DI UTILIZZO KIT BACHMANN**  
*scheme of use Bachmann electrification kit*

**BACHMANN**

SCRIVANIE SINGOLE  
 single desk

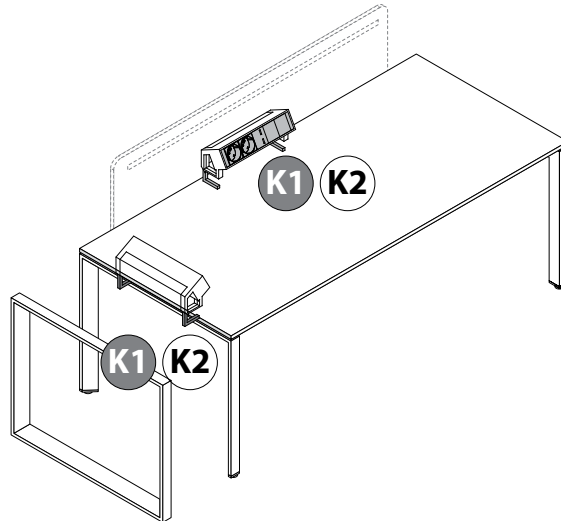

BENCH

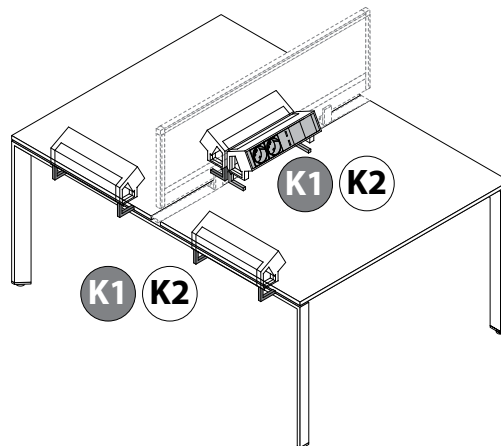

SYSTEM

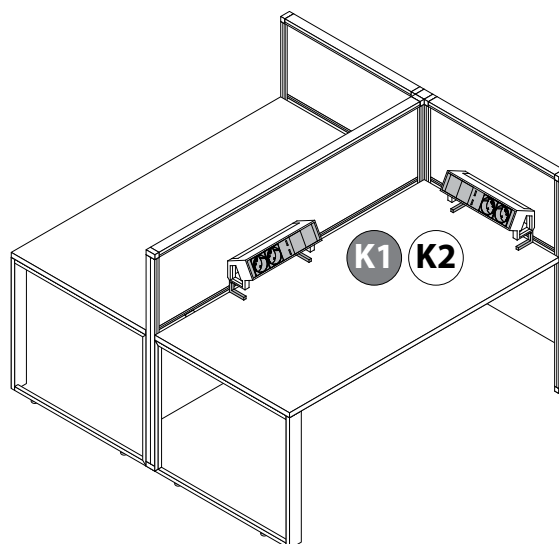

# Meeting

# 5<sup>TH</sup> ELEMENT





**TAVOLI RIUNIONE (PIANI SP. 18mm)**

meeting tables (tops thick. 18mm)

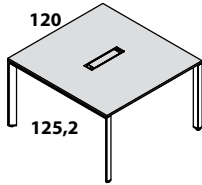
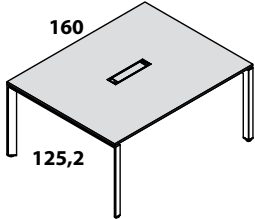
DESCRIZIONE description	L w	CODICE code	KG	M <sup>3</sup>	COLLI	PREZZO price	PREZZO price	(*) CODICE FINITURA (*) finish code																																																																																																																																																	
TAVOLI RIUNIONE L.120 x p.125,2 meeting table w 120 x d 125,2 cms    L.120 x p.125,2 x H.72,8	L.120	153 <b>180 (*)</b>	46	0,261	5	€ 500,00	€ 954,00	<input checked="" type="checkbox"/> <b>GAMBE VERNICIATE</b> ★ painted legs																																																																																																																																																	
								<input type="checkbox"/> <b>GAMBE CROMATE</b> ○ chromed legs																																																																																																																																																	
<input checked="" type="checkbox"/> <b>GAMBE VERNICIATE / painted legs</b>																																																																																																																																																									
<table border="1"> <thead> <tr> <th>(*)</th> <th>PIANO</th> <th>STRUTTURA</th> <th>top</th> <th>structure</th> </tr> </thead> <tbody> <tr><td>003</td><td>ROVERE</td><td>ARGENTO</td><td>oak</td><td>silver</td></tr> <tr><td>004</td><td>ROVERE GREY</td><td>ARGENTO</td><td>grey oak</td><td>silver</td></tr> <tr><td>020</td><td>ACERO TAKI</td><td>ARGENTO</td><td>taki maple</td><td>silver</td></tr> <tr><td>040</td><td>BIANCO BR.</td><td>ARGENTO</td><td>br. white</td><td>silver</td></tr> <tr><td>044</td><td>STONE GREY</td><td>ARGENTO</td><td>stone grey</td><td>silver</td></tr> <tr><td>066</td><td>NOCE PAVIA</td><td>ARGENTO</td><td>pavia walnut</td><td>silver</td></tr> <tr><td>090</td><td>WENGÈ</td><td>ARGENTO</td><td>wengè</td><td>silver</td></tr> <tr><td>400</td><td>BIANCO BR.</td><td>BIANCO</td><td>br. white</td><td>white</td></tr> <tr><td>403</td><td>ROVERE</td><td>BIANCO</td><td>oak</td><td>white</td></tr> <tr><td>404</td><td>ROVERE GREY</td><td>BIANCO</td><td>grey oak</td><td>white</td></tr> <tr><td>420</td><td>ACERO TAKI</td><td>BIANCO</td><td>taki maple</td><td>white</td></tr> <tr><td>444</td><td>STONE GREY</td><td>BIANCO</td><td>stone grey</td><td>white</td></tr> <tr><td>466</td><td>NOCE PAVIA</td><td>BIANCO</td><td>pavia walnut</td><td>white</td></tr> <tr><td>490</td><td>WENGÈ</td><td>BIANCO</td><td>wengè</td><td>white</td></tr> <tr><td>503</td><td>ROVERE</td><td>ANTRACITE</td><td>oak</td><td>anthracite</td></tr> <tr><td>504</td><td>ROVERE GREY</td><td>ANTRACITE</td><td>grey oak</td><td>anthracite</td></tr> <tr><td>521</td><td>ACERO TAKI</td><td>ANTRACITE</td><td>taki maple</td><td>anthracite</td></tr> <tr><td>541</td><td>BIANCO BR.</td><td>ANTRACITE</td><td>br. white</td><td>anthracite</td></tr> <tr><td>544</td><td>STONE GREY</td><td>ANTRACITE</td><td>stone grey</td><td>anthracite</td></tr> <tr><td>566</td><td>NOCE PAVIA</td><td>ANTRACITE</td><td>pavia walnut</td><td>anthracite</td></tr> <tr><td>591</td><td>WENGÈ</td><td>ANTRACITE</td><td>wengè</td><td>anthracite</td></tr> <tr><td>803</td><td>ROVERE</td><td>STONE GREY</td><td>oak</td><td>stone grey</td></tr> <tr><td>804</td><td>ROVERE GREY</td><td>STONE GREY</td><td>grey oak</td><td>stone grey</td></tr> <tr><td>820</td><td>ACERO TAKI</td><td>STONE GREY</td><td>taki maple</td><td>stone grey</td></tr> <tr><td>840</td><td>BIANCO BR.</td><td>STONE GREY</td><td>br. white</td><td>stone grey</td></tr> <tr><td>844</td><td>STONE GREY</td><td>STONE GREY</td><td>stone grey</td><td>stone grey</td></tr> <tr><td>866</td><td>NOCE PAVIA</td><td>STONE GREY</td><td>pavia walnut</td><td>stone grey</td></tr> <tr><td>890</td><td>WENGÈ</td><td>STONE GREY</td><td>wengè</td><td>stone grey</td></tr> </tbody> </table>									(*)	PIANO	STRUTTURA	top	structure	003	ROVERE	ARGENTO	oak	silver	004	ROVERE GREY	ARGENTO	grey oak	silver	020	ACERO TAKI	ARGENTO	taki maple	silver	040	BIANCO BR.	ARGENTO	br. white	silver	044	STONE GREY	ARGENTO	stone grey	silver	066	NOCE PAVIA	ARGENTO	pavia walnut	silver	090	WENGÈ	ARGENTO	wengè	silver	400	BIANCO BR.	BIANCO	br. white	white	403	ROVERE	BIANCO	oak	white	404	ROVERE GREY	BIANCO	grey oak	white	420	ACERO TAKI	BIANCO	taki maple	white	444	STONE GREY	BIANCO	stone grey	white	466	NOCE PAVIA	BIANCO	pavia walnut	white	490	WENGÈ	BIANCO	wengè	white	503	ROVERE	ANTRACITE	oak	anthracite	504	ROVERE GREY	ANTRACITE	grey oak	anthracite	521	ACERO TAKI	ANTRACITE	taki maple	anthracite	541	BIANCO BR.	ANTRACITE	br. white	anthracite	544	STONE GREY	ANTRACITE	stone grey	anthracite	566	NOCE PAVIA	ANTRACITE	pavia walnut	anthracite	591	WENGÈ	ANTRACITE	wengè	anthracite	803	ROVERE	STONE GREY	oak	stone grey	804	ROVERE GREY	STONE GREY	grey oak	stone grey	820	ACERO TAKI	STONE GREY	taki maple	stone grey	840	BIANCO BR.	STONE GREY	br. white	stone grey	844	STONE GREY	STONE GREY	stone grey	stone grey	866	NOCE PAVIA	STONE GREY	pavia walnut	stone grey	890	WENGÈ	STONE GREY	wengè	stone grey
(*)	PIANO	STRUTTURA	top	structure																																																																																																																																																					
003	ROVERE	ARGENTO	oak	silver																																																																																																																																																					
004	ROVERE GREY	ARGENTO	grey oak	silver																																																																																																																																																					
020	ACERO TAKI	ARGENTO	taki maple	silver																																																																																																																																																					
040	BIANCO BR.	ARGENTO	br. white	silver																																																																																																																																																					
044	STONE GREY	ARGENTO	stone grey	silver																																																																																																																																																					
066	NOCE PAVIA	ARGENTO	pavia walnut	silver																																																																																																																																																					
090	WENGÈ	ARGENTO	wengè	silver																																																																																																																																																					
400	BIANCO BR.	BIANCO	br. white	white																																																																																																																																																					
403	ROVERE	BIANCO	oak	white																																																																																																																																																					
404	ROVERE GREY	BIANCO	grey oak	white																																																																																																																																																					
420	ACERO TAKI	BIANCO	taki maple	white																																																																																																																																																					
444	STONE GREY	BIANCO	stone grey	white																																																																																																																																																					
466	NOCE PAVIA	BIANCO	pavia walnut	white																																																																																																																																																					
490	WENGÈ	BIANCO	wengè	white																																																																																																																																																					
503	ROVERE	ANTRACITE	oak	anthracite																																																																																																																																																					
504	ROVERE GREY	ANTRACITE	grey oak	anthracite																																																																																																																																																					
521	ACERO TAKI	ANTRACITE	taki maple	anthracite																																																																																																																																																					
541	BIANCO BR.	ANTRACITE	br. white	anthracite																																																																																																																																																					
544	STONE GREY	ANTRACITE	stone grey	anthracite																																																																																																																																																					
566	NOCE PAVIA	ANTRACITE	pavia walnut	anthracite																																																																																																																																																					
591	WENGÈ	ANTRACITE	wengè	anthracite																																																																																																																																																					
803	ROVERE	STONE GREY	oak	stone grey																																																																																																																																																					
804	ROVERE GREY	STONE GREY	grey oak	stone grey																																																																																																																																																					
820	ACERO TAKI	STONE GREY	taki maple	stone grey																																																																																																																																																					
840	BIANCO BR.	STONE GREY	br. white	stone grey																																																																																																																																																					
844	STONE GREY	STONE GREY	stone grey	stone grey																																																																																																																																																					
866	NOCE PAVIA	STONE GREY	pavia walnut	stone grey																																																																																																																																																					
890	WENGÈ	STONE GREY	wengè	stone grey																																																																																																																																																					
TAVOLO RIUNIONE L.160 x p.125,2 meeting table w 160 x d 125,2 cms    L.160 x p.125,2 x H.72,8	L.160	153 <b>194 (*)</b>	54	0,293	5	€ 550,00	€ 1.004,00	<input type="checkbox"/> <b>GAMBE CROMATE</b> ○ chromed legs																																																																																																																																																	
								<input checked="" type="checkbox"/> <b>GAMBE VERNICIATE</b> ★ painted legs																																																																																																																																																	
<input checked="" type="checkbox"/> <b>GAMBE VERNICIATE / painted legs</b>																																																																																																																																																									
<input type="checkbox"/> <b>GAMBE CROMATE / chromed legs</b>																																																																																																																																																									
<table border="1"> <tbody> <tr><td>903</td><td>ROVERE</td><td>CROMATO</td><td>oak</td><td>chromed</td></tr> <tr><td>904</td><td>ROVERE GREY</td><td>CROMATO</td><td>grey oak</td><td>chromed</td></tr> <tr><td>920</td><td>ACERO TAKI</td><td>CROMATO</td><td>taki maple</td><td>chromed</td></tr> <tr><td>940</td><td>BIANCO BR.</td><td>CROMATO</td><td>br. white</td><td>chromed</td></tr> <tr><td>944</td><td>STONE GREY</td><td>CROMATO</td><td>stone grey</td><td>chromed</td></tr> <tr><td>966</td><td>NOCE PAVIA</td><td>CROMATO</td><td>pavia walnut</td><td>chromed</td></tr> <tr><td>990</td><td>WENGÈ</td><td>CROMATO</td><td>wengè</td><td>chromed</td></tr> </tbody> </table>									903	ROVERE	CROMATO	oak	chromed	904	ROVERE GREY	CROMATO	grey oak	chromed	920	ACERO TAKI	CROMATO	taki maple	chromed	940	BIANCO BR.	CROMATO	br. white	chromed	944	STONE GREY	CROMATO	stone grey	chromed	966	NOCE PAVIA	CROMATO	pavia walnut	chromed	990	WENGÈ	CROMATO	wengè	chromed																																																																																																														
903	ROVERE	CROMATO	oak	chromed																																																																																																																																																					
904	ROVERE GREY	CROMATO	grey oak	chromed																																																																																																																																																					
920	ACERO TAKI	CROMATO	taki maple	chromed																																																																																																																																																					
940	BIANCO BR.	CROMATO	br. white	chromed																																																																																																																																																					
944	STONE GREY	CROMATO	stone grey	chromed																																																																																																																																																					
966	NOCE PAVIA	CROMATO	pavia walnut	chromed																																																																																																																																																					
990	WENGÈ	CROMATO	wengè	chromed																																																																																																																																																					

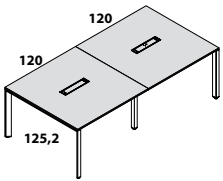
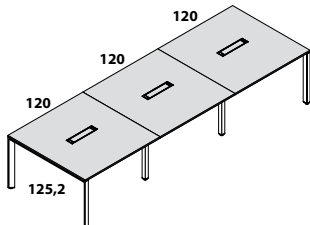
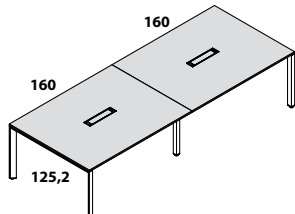
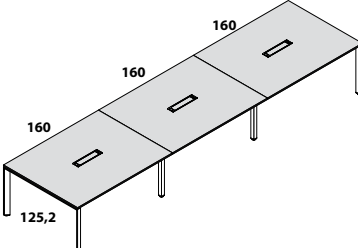

TAVOLI RIUNIONE (PIANI SP. 18mm) meeting tables (tops thick. 18mm)																																																																																																																																																								
DESCRIZIONE description	L w	CODICE code	KG	M <sup>3</sup>	COLLI	PREZZO price	(*) CODICE FINITURA (*) finish code																																																																																																																																																	
TAVOLO RIUNIONE L.240 x p.125,2 meeting table w 240 x d 125,2 cms    L.240 x p.125,2 x H.72,8	L.240	153 <b>136</b> (*)	81	0,477	9	€ 850,00	<b>GAMBE VERNICIATE</b> ★ painted legs																																																																																																																																																	
		<b>PER KIT WIRE-MANAGER GAMBA CENTRALE, VEDI ART. 738 A PAGINA SEGUENTE</b> <i>for wire-manager kit central leg, please see art.738 to next page</i>																																																																																																																																																						
TAVOLO RIUNIONE L.360 x p.125,2 meeting table w 360 x d 125,2 cms    L.360 x p.125,2 x H.72,8	L.360	153 <b>137</b> (*)	116	0,692	13	€ 1.200,00	<b>★ GAMBE VERNICIATE / painted legs</b> <table border="1"> <thead> <tr> <th>(*)</th> <th>PIANO</th> <th>STRUTTURA</th> <th>top</th> <th>structure</th> </tr> </thead> <tbody> <tr><td>003</td><td>ROVERE</td><td>ARGENTO</td><td>oak</td><td>silver</td></tr> <tr><td>004</td><td>ROVERE GREY</td><td>ARGENTO</td><td>grey oak</td><td>silver</td></tr> <tr><td>020</td><td>ACERO TAKI</td><td>ARGENTO</td><td>taki maple</td><td>silver</td></tr> <tr><td>040</td><td>BIANCO BR.</td><td>ARGENTO</td><td>br. white</td><td>silver</td></tr> <tr><td>044</td><td>STONE GREY</td><td>ARGENTO</td><td>stone grey</td><td>silver</td></tr> <tr><td>066</td><td>NOCE PAVIA</td><td>ARGENTO</td><td>pavia walnut</td><td>silver</td></tr> <tr><td>090</td><td>'WENGE'</td><td>ARGENTO</td><td>wengè</td><td>silver</td></tr> <tr><td>400</td><td>BIANCO BR.</td><td>BIANCO</td><td>br. white</td><td>white</td></tr> <tr><td>403</td><td>ROVERE</td><td>BIANCO</td><td>oak</td><td>white</td></tr> <tr><td>404</td><td>ROVERE GREY</td><td>BIANCO</td><td>grey oak</td><td>white</td></tr> <tr><td>420</td><td>ACERO TAKI</td><td>BIANCO</td><td>taki maple</td><td>white</td></tr> <tr><td>444</td><td>STONE GREY</td><td>BIANCO</td><td>stone grey</td><td>white</td></tr> <tr><td>466</td><td>NOCE PAVIA</td><td>BIANCO</td><td>pavia walnut</td><td>white</td></tr> <tr><td>490</td><td>'WENGE'</td><td>BIANCO</td><td>wengè</td><td>white</td></tr> <tr><td>503</td><td>ROVERE</td><td>ANTRACITE</td><td>oak</td><td>anthracite</td></tr> <tr><td>504</td><td>ROVERE GREY</td><td>ANTRACITE</td><td>grey oak</td><td>anthracite</td></tr> <tr><td>521</td><td>ACERO TAKI</td><td>ANTRACITE</td><td>taki maple</td><td>anthracite</td></tr> <tr><td>541</td><td>BIANCO BR.</td><td>ANTRACITE</td><td>br. white</td><td>anthracite</td></tr> <tr><td>544</td><td>STONE GREY</td><td>ANTRACITE</td><td>stone grey</td><td>anthracite</td></tr> <tr><td>566</td><td>NOCE PAVIA</td><td>ANTRACITE</td><td>pavia walnut</td><td>anthracite</td></tr> <tr><td>591</td><td>'WENGE'</td><td>ANTRACITE</td><td>wengè</td><td>anthracite</td></tr> <tr><td>803</td><td>ROVERE</td><td>STONE GREY</td><td>oak</td><td>stone grey</td></tr> <tr><td>804</td><td>ROVERE GREY</td><td>STONE GREY</td><td>grey oak</td><td>stone grey</td></tr> <tr><td>820</td><td>ACERO TAKI</td><td>STONE GREY</td><td>taki maple</td><td>stone grey</td></tr> <tr><td>840</td><td>BIANCO BR.</td><td>STONE GREY</td><td>br. white</td><td>stone grey</td></tr> <tr><td>844</td><td>STONE GREY</td><td>STONE GREY</td><td>stone grey</td><td>stone grey</td></tr> <tr><td>866</td><td>NOCE PAVIA</td><td>STONE GREY</td><td>pavia walnut</td><td>stone grey</td></tr> <tr><td>890</td><td>'WENGE'</td><td>STONE GREY</td><td>wengè</td><td>stone grey</td></tr> </tbody> </table>	(*)	PIANO	STRUTTURA	top	structure	003	ROVERE	ARGENTO	oak	silver	004	ROVERE GREY	ARGENTO	grey oak	silver	020	ACERO TAKI	ARGENTO	taki maple	silver	040	BIANCO BR.	ARGENTO	br. white	silver	044	STONE GREY	ARGENTO	stone grey	silver	066	NOCE PAVIA	ARGENTO	pavia walnut	silver	090	'WENGE'	ARGENTO	wengè	silver	400	BIANCO BR.	BIANCO	br. white	white	403	ROVERE	BIANCO	oak	white	404	ROVERE GREY	BIANCO	grey oak	white	420	ACERO TAKI	BIANCO	taki maple	white	444	STONE GREY	BIANCO	stone grey	white	466	NOCE PAVIA	BIANCO	pavia walnut	white	490	'WENGE'	BIANCO	wengè	white	503	ROVERE	ANTRACITE	oak	anthracite	504	ROVERE GREY	ANTRACITE	grey oak	anthracite	521	ACERO TAKI	ANTRACITE	taki maple	anthracite	541	BIANCO BR.	ANTRACITE	br. white	anthracite	544	STONE GREY	ANTRACITE	stone grey	anthracite	566	NOCE PAVIA	ANTRACITE	pavia walnut	anthracite	591	'WENGE'	ANTRACITE	wengè	anthracite	803	ROVERE	STONE GREY	oak	stone grey	804	ROVERE GREY	STONE GREY	grey oak	stone grey	820	ACERO TAKI	STONE GREY	taki maple	stone grey	840	BIANCO BR.	STONE GREY	br. white	stone grey	844	STONE GREY	STONE GREY	stone grey	stone grey	866	NOCE PAVIA	STONE GREY	pavia walnut	stone grey	890	'WENGE'	STONE GREY	wengè	stone grey
		(*)	PIANO	STRUTTURA	top	structure																																																																																																																																																		
		003	ROVERE	ARGENTO	oak	silver																																																																																																																																																		
004	ROVERE GREY	ARGENTO	grey oak	silver																																																																																																																																																				
020	ACERO TAKI	ARGENTO	taki maple	silver																																																																																																																																																				
040	BIANCO BR.	ARGENTO	br. white	silver																																																																																																																																																				
044	STONE GREY	ARGENTO	stone grey	silver																																																																																																																																																				
066	NOCE PAVIA	ARGENTO	pavia walnut	silver																																																																																																																																																				
090	'WENGE'	ARGENTO	wengè	silver																																																																																																																																																				
400	BIANCO BR.	BIANCO	br. white	white																																																																																																																																																				
403	ROVERE	BIANCO	oak	white																																																																																																																																																				
404	ROVERE GREY	BIANCO	grey oak	white																																																																																																																																																				
420	ACERO TAKI	BIANCO	taki maple	white																																																																																																																																																				
444	STONE GREY	BIANCO	stone grey	white																																																																																																																																																				
466	NOCE PAVIA	BIANCO	pavia walnut	white																																																																																																																																																				
490	'WENGE'	BIANCO	wengè	white																																																																																																																																																				
503	ROVERE	ANTRACITE	oak	anthracite																																																																																																																																																				
504	ROVERE GREY	ANTRACITE	grey oak	anthracite																																																																																																																																																				
521	ACERO TAKI	ANTRACITE	taki maple	anthracite																																																																																																																																																				
541	BIANCO BR.	ANTRACITE	br. white	anthracite																																																																																																																																																				
544	STONE GREY	ANTRACITE	stone grey	anthracite																																																																																																																																																				
566	NOCE PAVIA	ANTRACITE	pavia walnut	anthracite																																																																																																																																																				
591	'WENGE'	ANTRACITE	wengè	anthracite																																																																																																																																																				
803	ROVERE	STONE GREY	oak	stone grey																																																																																																																																																				
804	ROVERE GREY	STONE GREY	grey oak	stone grey																																																																																																																																																				
820	ACERO TAKI	STONE GREY	taki maple	stone grey																																																																																																																																																				
840	BIANCO BR.	STONE GREY	br. white	stone grey																																																																																																																																																				
844	STONE GREY	STONE GREY	stone grey	stone grey																																																																																																																																																				
866	NOCE PAVIA	STONE GREY	pavia walnut	stone grey																																																																																																																																																				
890	'WENGE'	STONE GREY	wengè	stone grey																																																																																																																																																				
<b>PER KIT WIRE-MANAGER GAMBA CENTRALE, VEDI ART. 738 A PAGINA SEGUENTE</b> <i>for wire-manager kit central leg, please see art.738 to next page</i>																																																																																																																																																								
TAVOLO RIUNIONE L.320 x p.125,2 meeting table w 320 x d 125,2 cms    L.320 x p.125,2 x H.72,8	L.320	153 <b>181</b> (*)	97	0,540	9	€ 950,00	<b>★ GAMBE VERNICIATE / painted legs</b> <table border="1"> <thead> <tr> <th>(*)</th> <th>PIANO</th> <th>STRUTTURA</th> <th>top</th> <th>structure</th> </tr> </thead> <tbody> <tr><td>503</td><td>ROVERE</td><td>ANTRACITE</td><td>oak</td><td>anthracite</td></tr> <tr><td>504</td><td>ROVERE GREY</td><td>ANTRACITE</td><td>grey oak</td><td>anthracite</td></tr> <tr><td>521</td><td>ACERO TAKI</td><td>ANTRACITE</td><td>taki maple</td><td>anthracite</td></tr> <tr><td>541</td><td>BIANCO BR.</td><td>ANTRACITE</td><td>br. white</td><td>anthracite</td></tr> <tr><td>544</td><td>STONE GREY</td><td>ANTRACITE</td><td>stone grey</td><td>anthracite</td></tr> <tr><td>566</td><td>NOCE PAVIA</td><td>ANTRACITE</td><td>pavia walnut</td><td>anthracite</td></tr> <tr><td>591</td><td>'WENGE'</td><td>ANTRACITE</td><td>wengè</td><td>anthracite</td></tr> <tr><td>803</td><td>ROVERE</td><td>STONE GREY</td><td>oak</td><td>stone grey</td></tr> <tr><td>804</td><td>ROVERE GREY</td><td>STONE GREY</td><td>grey oak</td><td>stone grey</td></tr> <tr><td>820</td><td>ACERO TAKI</td><td>STONE GREY</td><td>taki maple</td><td>stone grey</td></tr> <tr><td>840</td><td>BIANCO BR.</td><td>STONE GREY</td><td>br. white</td><td>stone grey</td></tr> <tr><td>844</td><td>STONE GREY</td><td>STONE GREY</td><td>stone grey</td><td>stone grey</td></tr> <tr><td>866</td><td>NOCE PAVIA</td><td>STONE GREY</td><td>pavia walnut</td><td>stone grey</td></tr> <tr><td>890</td><td>'WENGE'</td><td>STONE GREY</td><td>wengè</td><td>stone grey</td></tr> </tbody> </table>	(*)	PIANO	STRUTTURA	top	structure	503	ROVERE	ANTRACITE	oak	anthracite	504	ROVERE GREY	ANTRACITE	grey oak	anthracite	521	ACERO TAKI	ANTRACITE	taki maple	anthracite	541	BIANCO BR.	ANTRACITE	br. white	anthracite	544	STONE GREY	ANTRACITE	stone grey	anthracite	566	NOCE PAVIA	ANTRACITE	pavia walnut	anthracite	591	'WENGE'	ANTRACITE	wengè	anthracite	803	ROVERE	STONE GREY	oak	stone grey	804	ROVERE GREY	STONE GREY	grey oak	stone grey	820	ACERO TAKI	STONE GREY	taki maple	stone grey	840	BIANCO BR.	STONE GREY	br. white	stone grey	844	STONE GREY	STONE GREY	stone grey	stone grey	866	NOCE PAVIA	STONE GREY	pavia walnut	stone grey	890	'WENGE'	STONE GREY	wengè	stone grey																																																																						
		(*)	PIANO	STRUTTURA	top	structure																																																																																																																																																		
		503	ROVERE	ANTRACITE	oak	anthracite																																																																																																																																																		
504	ROVERE GREY	ANTRACITE	grey oak	anthracite																																																																																																																																																				
521	ACERO TAKI	ANTRACITE	taki maple	anthracite																																																																																																																																																				
541	BIANCO BR.	ANTRACITE	br. white	anthracite																																																																																																																																																				
544	STONE GREY	ANTRACITE	stone grey	anthracite																																																																																																																																																				
566	NOCE PAVIA	ANTRACITE	pavia walnut	anthracite																																																																																																																																																				
591	'WENGE'	ANTRACITE	wengè	anthracite																																																																																																																																																				
803	ROVERE	STONE GREY	oak	stone grey																																																																																																																																																				
804	ROVERE GREY	STONE GREY	grey oak	stone grey																																																																																																																																																				
820	ACERO TAKI	STONE GREY	taki maple	stone grey																																																																																																																																																				
840	BIANCO BR.	STONE GREY	br. white	stone grey																																																																																																																																																				
844	STONE GREY	STONE GREY	stone grey	stone grey																																																																																																																																																				
866	NOCE PAVIA	STONE GREY	pavia walnut	stone grey																																																																																																																																																				
890	'WENGE'	STONE GREY	wengè	stone grey																																																																																																																																																				
<b>PER KIT WIRE-MANAGER GAMBA CENTRALE, VEDI ART. 738 A PAGINA SEGUENTE</b> <i>for wire-manager kit central leg, please see art.738 to next page</i>																																																																																																																																																								
TAVOLO RIUNIONE L.480 x p.125,2 meeting table w 480 x d 125,2 cms    L.480 x p.125,2 x H.72,8	L.480	153 <b>182</b> (*)	140	0,788	13	€ 1.350,00	<b>★ GAMBE VERNICIATE / painted legs</b> <table border="1"> <thead> <tr> <th>(*)</th> <th>PIANO</th> <th>STRUTTURA</th> <th>top</th> <th>structure</th> </tr> </thead> <tbody> <tr><td>503</td><td>ROVERE</td><td>ANTRACITE</td><td>oak</td><td>anthracite</td></tr> <tr><td>504</td><td>ROVERE GREY</td><td>ANTRACITE</td><td>grey oak</td><td>anthracite</td></tr> <tr><td>521</td><td>ACERO TAKI</td><td>ANTRACITE</td><td>taki maple</td><td>anthracite</td></tr> <tr><td>541</td><td>BIANCO BR.</td><td>ANTRACITE</td><td>br. white</td><td>anthracite</td></tr> <tr><td>544</td><td>STONE GREY</td><td>ANTRACITE</td><td>stone grey</td><td>anthracite</td></tr> <tr><td>566</td><td>NOCE PAVIA</td><td>ANTRACITE</td><td>pavia walnut</td><td>anthracite</td></tr> <tr><td>591</td><td>'WENGE'</td><td>ANTRACITE</td><td>wengè</td><td>anthracite</td></tr> <tr><td>803</td><td>ROVERE</td><td>STONE GREY</td><td>oak</td><td>stone grey</td></tr> <tr><td>804</td><td>ROVERE GREY</td><td>STONE GREY</td><td>grey oak</td><td>stone grey</td></tr> <tr><td>820</td><td>ACERO TAKI</td><td>STONE GREY</td><td>taki maple</td><td>stone grey</td></tr> <tr><td>840</td><td>BIANCO BR.</td><td>STONE GREY</td><td>br. white</td><td>stone grey</td></tr> <tr><td>844</td><td>STONE GREY</td><td>STONE GREY</td><td>stone grey</td><td>stone grey</td></tr> <tr><td>866</td><td>NOCE PAVIA</td><td>STONE GREY</td><td>pavia walnut</td><td>stone grey</td></tr> <tr><td>890</td><td>'WENGE'</td><td>STONE GREY</td><td>wengè</td><td>stone grey</td></tr> </tbody> </table>	(*)	PIANO	STRUTTURA	top	structure	503	ROVERE	ANTRACITE	oak	anthracite	504	ROVERE GREY	ANTRACITE	grey oak	anthracite	521	ACERO TAKI	ANTRACITE	taki maple	anthracite	541	BIANCO BR.	ANTRACITE	br. white	anthracite	544	STONE GREY	ANTRACITE	stone grey	anthracite	566	NOCE PAVIA	ANTRACITE	pavia walnut	anthracite	591	'WENGE'	ANTRACITE	wengè	anthracite	803	ROVERE	STONE GREY	oak	stone grey	804	ROVERE GREY	STONE GREY	grey oak	stone grey	820	ACERO TAKI	STONE GREY	taki maple	stone grey	840	BIANCO BR.	STONE GREY	br. white	stone grey	844	STONE GREY	STONE GREY	stone grey	stone grey	866	NOCE PAVIA	STONE GREY	pavia walnut	stone grey	890	'WENGE'	STONE GREY	wengè	stone grey																																																																						
		(*)	PIANO	STRUTTURA	top	structure																																																																																																																																																		
		503	ROVERE	ANTRACITE	oak	anthracite																																																																																																																																																		
504	ROVERE GREY	ANTRACITE	grey oak	anthracite																																																																																																																																																				
521	ACERO TAKI	ANTRACITE	taki maple	anthracite																																																																																																																																																				
541	BIANCO BR.	ANTRACITE	br. white	anthracite																																																																																																																																																				
544	STONE GREY	ANTRACITE	stone grey	anthracite																																																																																																																																																				
566	NOCE PAVIA	ANTRACITE	pavia walnut	anthracite																																																																																																																																																				
591	'WENGE'	ANTRACITE	wengè	anthracite																																																																																																																																																				
803	ROVERE	STONE GREY	oak	stone grey																																																																																																																																																				
804	ROVERE GREY	STONE GREY	grey oak	stone grey																																																																																																																																																				
820	ACERO TAKI	STONE GREY	taki maple	stone grey																																																																																																																																																				
840	BIANCO BR.	STONE GREY	br. white	stone grey																																																																																																																																																				
844	STONE GREY	STONE GREY	stone grey	stone grey																																																																																																																																																				
866	NOCE PAVIA	STONE GREY	pavia walnut	stone grey																																																																																																																																																				
890	'WENGE'	STONE GREY	wengè	stone grey																																																																																																																																																				
<b>PER KIT WIRE-MANAGER GAMBA CENTRALE, VEDI ART. 738 A PAGINA SEGUENTE</b> <i>for wire-manager kit central leg, please see art.738 to next page</i>																																																																																																																																																								

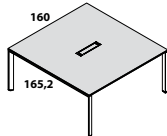
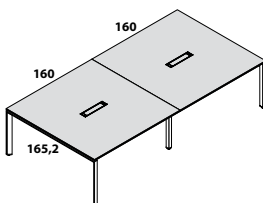
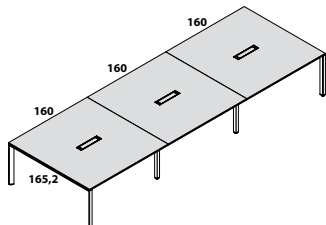
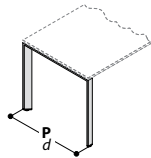
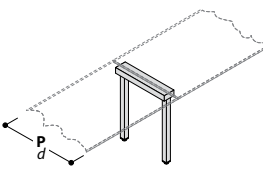
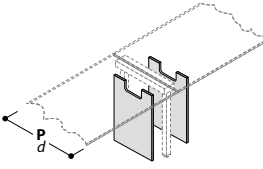
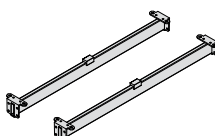
TAVOLI RIUNIONE (PIANI SP. 18mm) meeting tables (tops thick. 18mm)							
DESCRIZIONE description	L w	CODICE code	KG	M <sup>3</sup>	COLLI	PREZZO price	(*) CODICE FINITURA (*) finish code
TAVOLO RIUNIONE L.160 x p.165,2 meeting table w 160 x d 165,2 cms    L.160 x p.165,2 x H.72,8	L.160	153 185 (*)	58	0,361	5	€ 625,00	<b>GAMBE VERNICIATE</b> ★ painted legs
TAVOLO RIUNIONE L.320 x p.165,2 meeting table w 320 x d 165,2 cms    L.320 x p.165,2 x H.72,8	L.320	153 186 (*)	105	0,676	9	€ 1.066,00	<b>GAMBE VERNICIATE / painted legs</b>
TAVOLO RIUNIONE L.480 x p.165,2 meeting table w 480 x d 165,2 cms    L.480 x p.165,2 x H.72,8	L.480	153 187 (*)	152	0,991	13	€ 1.507,00	<b>GAMBE VERNICIATE / painted legs</b>
<b>GAMBE METALLICHE A PONTE E TRAVI DI SUPPORTO</b> <i>bridge metal legs and support beams</i>							
GAMBE TERMINALI terminal legs    H.71	p.125	153 702 (*)	11	0,077	1	€ 128,00	
	p.165	153 703 (*)	13	0,098	1	€ 152,00	
GAMBE CENTRALI APERTE open central legs    H.71	p.125	153 708 (*)	11	0,108	1	€ 106,00	
	p.165	153 709 (*)	15	0,149	1	€ 120,00	
KIT WIRE-MANAGER PER GAMBA A PONTE CENTRALE wire-manager kit for central bridge leg    H.71	p.125	153 738 (*)	10	0,046	1	€ 117,00	
	p.165	153 739 (*)	12	0,068	1	€ 119,00	
COPPIA DI TRAVI PER GAMBE A PONTE set of 2 beams for bridge legs  	L.120	153 721 (*)	3	0,021	1	€ 68,00	
	L.160	153 723 (*)	5	0,027	1	€ 81,00	
							(*) ARGENTO silver 400 BIANCO white 551 ANTRACITE anthracite 844 STONE GREY stone grey

**PIANI TAVOLI RIUNIONE (PIANI SP. 18mm)**

meeting tables tops (tops thick. 18mm)

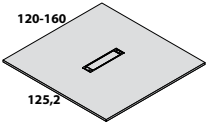
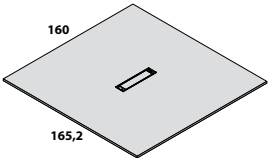
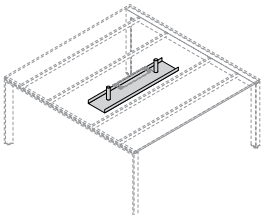
DESCRIZIONE description	L w	CODICE code	KG	M <sup>3</sup>	COLLI	PREZZO price	(*) CODICE FINITURA (*) finish code						
PIANI TAVOLI RIUNIONE PROF. CM 125,2 <i>meeting table tops deep 125,2 cms</i>    L. x p. 125,2 x H.1,8	<b>SENZA TOP ACCESS</b> without top access												
	L.120	153 <b>536</b> (*)	18	0,064	1	€ 83,00							
	L.160	153 <b>539</b> (*)	22	0,085	1	€ 107,00							
	<b>CON TOP ACCESS</b> with top access												
	L.120	153 <b>826</b> (*)	18	0,064	1	€ 108,00	(*) PIANO top						
	L.160	153 <b>825</b> (*)	22	0,085	1	€ 132,00	166 NOCE PAVIA pavia walnut 200 ACERO TAKI taki maple 400 BIANCO BR. br. white 704 ROVERE GREY grey oak 733 ROVERE oak 844 STONE GREY stone grey 900 WENGE' wenge						
PIANO TAVOLO RIUNIONE PROF. CM 165,2 <i>meeting table tops deep 165,2 cms</i>    L. x p. 165,2 x H.1,8	<b>SENZA TOP ACCESS</b> without top access												
	L.160	153 <b>543</b> (*)	22	0,111	1	€ 137,00							
	<b>CON TOP ACCESS</b> with top access												
	L.160	153 <b>827</b> (*)	22	0,111	1	€ 159,00							
VASCHEE CENTRALI PASSACAVI <b>PER TAVOLI RIUNIONE</b> <i>central cable trays for meeting tables</i>    L. x p. 20 x H.10	L.90	153 <b>241</b> (*)	2	0,013	1	€ 54,00							
	L.121	153 <b>243</b> (*)	3	0,023	1	€ 61,00	(*)						
	PROSPETTO INFORMATIVO <i>fact-sheet</i> <table border="1" style="margin: auto;"> <tr> <td>VASCHEE CENTRALI central cable tray</td> <td>UTILIZZABILE SU PIANI usable on the meeting table tops</td> </tr> <tr> <td>ART.241</td> <td>L.120</td> </tr> <tr> <td>ART.243</td> <td>L.160</td> </tr> </table>							VASCHEE CENTRALI central cable tray	UTILIZZABILE SU PIANI usable on the meeting table tops	ART.241	L.120	ART.243	L.160
	VASCHEE CENTRALI central cable tray	UTILIZZABILE SU PIANI usable on the meeting table tops											
ART.241	L.120												
ART.243	L.160												
							000 ARGENTO silver 400 BIANCO white 551 ANTRACITE anthracite 844 STONE GREY stone grey						

**PER SOSTENERE I PIANI UTILIZZARE LA STRUTTURA METALLICA A PONTE**

use the bridge metal structure to support the meeting table tops

ESEMPIO:

example:

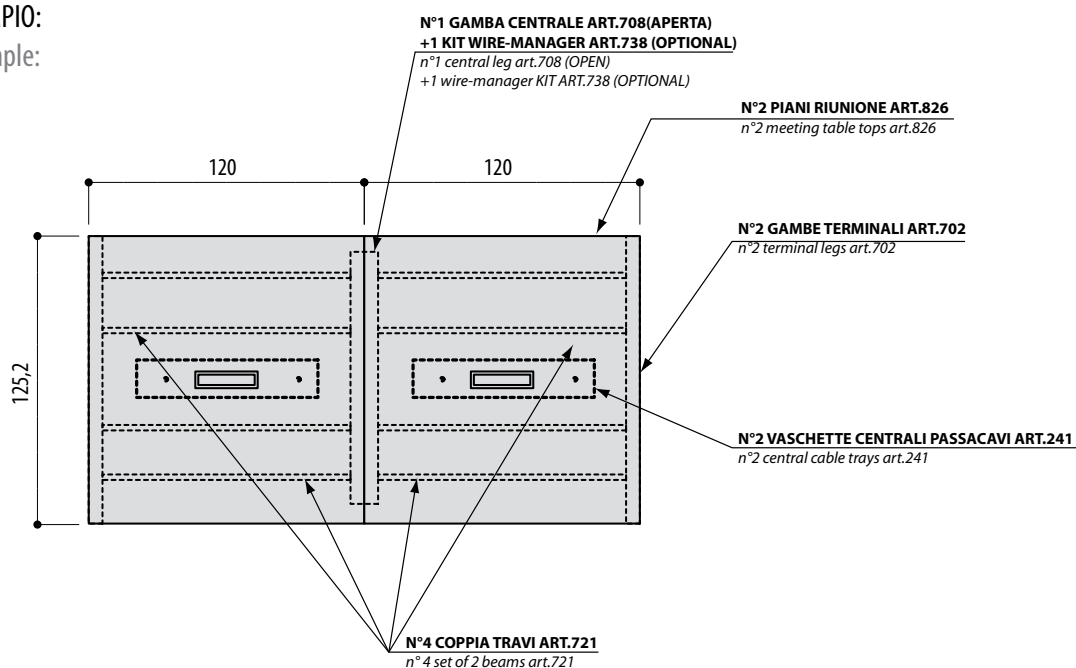

# TAVOLI TEAM (PIANI SP. 18mm)

team tables (tops thick. 18mm)

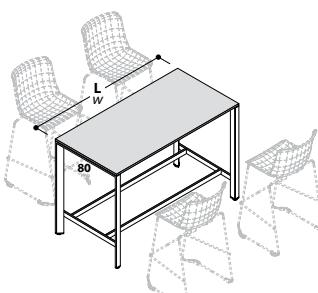
DESCRIZIONE description	L w	CODICE code	KG	M <sup>3</sup>	COLLI PCS	PREZZO price	(*) CODICE FINITURA (*) finish code																																																																																																																																																	
TAVOLI TEAM team tables  	<b>GAMBE VERNICIATE</b> ★ painted legs																																																																																																																																																							
	<b>★ GAMBE VERNICIATE / painted legs</b>																																																																																																																																																							
							<table border="1"> <thead> <tr> <th>(*)</th> <th>PIANO</th> <th>STRUTTURA</th> <th>top</th> <th>structure</th> </tr> </thead> <tbody> <tr><td>003</td><td>ROVERE</td><td>ARGENTO</td><td>oak</td><td>silver</td></tr> <tr><td>004</td><td>ROVERE GREY</td><td>ARGENTO</td><td>grey oak</td><td>silver</td></tr> <tr><td>020</td><td>ACERO TAKI</td><td>ARGENTO</td><td>taki maple</td><td>silver</td></tr> <tr><td>040</td><td>BIANCO BR.</td><td>ARGENTO</td><td>br. white</td><td>silver</td></tr> <tr><td>044</td><td>STONE GREY</td><td>ARGENTO</td><td>stone grey</td><td>silver</td></tr> <tr><td>066</td><td>NOCE PAVIA</td><td>ARGENTO</td><td>pavia walnut</td><td>silver</td></tr> <tr><td>090</td><td>'WENGÉ'</td><td>ARGENTO</td><td>wengé</td><td>silver</td></tr> <tr><td>400</td><td>BIANCO BR.</td><td>BIANCO</td><td>br. white</td><td>white</td></tr> <tr><td>403</td><td>ROVERE</td><td>BIANCO</td><td>oak</td><td>white</td></tr> <tr><td>404</td><td>ROVERE GREY</td><td>BIANCO</td><td>grey oak</td><td>white</td></tr> <tr><td>420</td><td>ACERO TAKI</td><td>BIANCO</td><td>taki maple</td><td>white</td></tr> <tr><td>444</td><td>STONE GREY</td><td>BIANCO</td><td>stone grey</td><td>white</td></tr> <tr><td>466</td><td>NOCE PAVIA</td><td>BIANCO</td><td>pavia walnut</td><td>white</td></tr> <tr><td>490</td><td>'WENGÉ'</td><td>BIANCO</td><td>wengé</td><td>white</td></tr> <tr><td>503</td><td>ROVERE</td><td>ANTRACITE</td><td>oak</td><td>anthracite</td></tr> <tr><td>504</td><td>ROVERE GREY</td><td>ANTRACITE</td><td>grey oak</td><td>anthracite</td></tr> <tr><td>521</td><td>ACERO TAKI</td><td>ANTRACITE</td><td>taki maple</td><td>anthracite</td></tr> <tr><td>541</td><td>BIANCO BR.</td><td>ANTRACITE</td><td>br. white</td><td>anthracite</td></tr> <tr><td>544</td><td>STONE GREY</td><td>ANTRACITE</td><td>stone grey</td><td>anthracite</td></tr> <tr><td>566</td><td>NOCE PAVIA</td><td>ANTRACITE</td><td>pavia walnut</td><td>anthracite</td></tr> <tr><td>591</td><td>'WENGÉ'</td><td>ANTRACITE</td><td>wengé</td><td>anthracite</td></tr> <tr><td>803</td><td>ROVERE</td><td>STONE GREY</td><td>oak</td><td>stone grey</td></tr> <tr><td>804</td><td>ROVERE GREY</td><td>STONE GREY</td><td>grey oak</td><td>stone grey</td></tr> <tr><td>820</td><td>ACERO TAKI</td><td>STONE GREY</td><td>taki maple</td><td>stone grey</td></tr> <tr><td>840</td><td>BIANCO BR.</td><td>STONE GREY</td><td>br. white</td><td>stone grey</td></tr> <tr><td>844</td><td>STONE GREY</td><td>STONE GREY</td><td>stone grey</td><td>stone grey</td></tr> <tr><td>866</td><td>NOCE PAVIA</td><td>STONE GREY</td><td>pavia walnut</td><td>stone grey</td></tr> <tr><td>890</td><td>'WENGÉ'</td><td>STONE GREY</td><td>wengé</td><td>stone grey</td></tr> </tbody> </table>	(*)	PIANO	STRUTTURA	top	structure	003	ROVERE	ARGENTO	oak	silver	004	ROVERE GREY	ARGENTO	grey oak	silver	020	ACERO TAKI	ARGENTO	taki maple	silver	040	BIANCO BR.	ARGENTO	br. white	silver	044	STONE GREY	ARGENTO	stone grey	silver	066	NOCE PAVIA	ARGENTO	pavia walnut	silver	090	'WENGÉ'	ARGENTO	wengé	silver	400	BIANCO BR.	BIANCO	br. white	white	403	ROVERE	BIANCO	oak	white	404	ROVERE GREY	BIANCO	grey oak	white	420	ACERO TAKI	BIANCO	taki maple	white	444	STONE GREY	BIANCO	stone grey	white	466	NOCE PAVIA	BIANCO	pavia walnut	white	490	'WENGÉ'	BIANCO	wengé	white	503	ROVERE	ANTRACITE	oak	anthracite	504	ROVERE GREY	ANTRACITE	grey oak	anthracite	521	ACERO TAKI	ANTRACITE	taki maple	anthracite	541	BIANCO BR.	ANTRACITE	br. white	anthracite	544	STONE GREY	ANTRACITE	stone grey	anthracite	566	NOCE PAVIA	ANTRACITE	pavia walnut	anthracite	591	'WENGÉ'	ANTRACITE	wengé	anthracite	803	ROVERE	STONE GREY	oak	stone grey	804	ROVERE GREY	STONE GREY	grey oak	stone grey	820	ACERO TAKI	STONE GREY	taki maple	stone grey	840	BIANCO BR.	STONE GREY	br. white	stone grey	844	STONE GREY	STONE GREY	stone grey	stone grey	866	NOCE PAVIA	STONE GREY	pavia walnut	stone grey	890	'WENGÉ'	STONE GREY	wengé	stone grey
(*)	PIANO	STRUTTURA	top	structure																																																																																																																																																				
003	ROVERE	ARGENTO	oak	silver																																																																																																																																																				
004	ROVERE GREY	ARGENTO	grey oak	silver																																																																																																																																																				
020	ACERO TAKI	ARGENTO	taki maple	silver																																																																																																																																																				
040	BIANCO BR.	ARGENTO	br. white	silver																																																																																																																																																				
044	STONE GREY	ARGENTO	stone grey	silver																																																																																																																																																				
066	NOCE PAVIA	ARGENTO	pavia walnut	silver																																																																																																																																																				
090	'WENGÉ'	ARGENTO	wengé	silver																																																																																																																																																				
400	BIANCO BR.	BIANCO	br. white	white																																																																																																																																																				
403	ROVERE	BIANCO	oak	white																																																																																																																																																				
404	ROVERE GREY	BIANCO	grey oak	white																																																																																																																																																				
420	ACERO TAKI	BIANCO	taki maple	white																																																																																																																																																				
444	STONE GREY	BIANCO	stone grey	white																																																																																																																																																				
466	NOCE PAVIA	BIANCO	pavia walnut	white																																																																																																																																																				
490	'WENGÉ'	BIANCO	wengé	white																																																																																																																																																				
503	ROVERE	ANTRACITE	oak	anthracite																																																																																																																																																				
504	ROVERE GREY	ANTRACITE	grey oak	anthracite																																																																																																																																																				
521	ACERO TAKI	ANTRACITE	taki maple	anthracite																																																																																																																																																				
541	BIANCO BR.	ANTRACITE	br. white	anthracite																																																																																																																																																				
544	STONE GREY	ANTRACITE	stone grey	anthracite																																																																																																																																																				
566	NOCE PAVIA	ANTRACITE	pavia walnut	anthracite																																																																																																																																																				
591	'WENGÉ'	ANTRACITE	wengé	anthracite																																																																																																																																																				
803	ROVERE	STONE GREY	oak	stone grey																																																																																																																																																				
804	ROVERE GREY	STONE GREY	grey oak	stone grey																																																																																																																																																				
820	ACERO TAKI	STONE GREY	taki maple	stone grey																																																																																																																																																				
840	BIANCO BR.	STONE GREY	br. white	stone grey																																																																																																																																																				
844	STONE GREY	STONE GREY	stone grey	stone grey																																																																																																																																																				
866	NOCE PAVIA	STONE GREY	pavia walnut	stone grey																																																																																																																																																				
890	'WENGÉ'	STONE GREY	wengé	stone grey																																																																																																																																																				
	L.160	153 <b>267</b> (*)	46	0,174	4	€ 654,00																																																																																																																																																		
	L.180	153 <b>268</b> (*)	50	0,183	4	€ 685,00																																																																																																																																																		
L. x p.80 x H.105																																																																																																																																																								

# 5<sup>TH</sup> ELEMENT

## DESCRIZIONE TECNICA

### SCRIVANIE DIREZIONALI CON GAMBE A PONTE O "LOOP e MOBILE-BASE (EXECUTIVE):

**I piani di lavoro** sono disponibili in 2 versioni: legno o vetro.

- Il piano in legno è realizzato con pannello di particelle di legno sp. mm 18 nobilitato in melaminico (Classe E1 basso contenuto di Formaldeide ) e bordato perimetralmente in ABS mm 2 in tinta con la superficie e disponibili nei colori: ROVERE 03, ROVERE GREY 04, NOCE PAVIA 06, STONE GREY 44, WENG' 45, ACERO TAKI 58, BIANCO BR. 69.

- Il piano vetro è del tipo float temperato sp. mm 10 retrolaccato, con bordi perimetrali lavorati a filo lucido, è utilizzabile solo in abbinamento alla struttura metallica ed ancorati alla stessa mediante supporti torniti in acciaio inox. Il piano in vetro è disponibile nei colori: NERO 10, TORTORA 72, ROSSO RUBINO 74, BIANCO 79.

**Le gambe a PONTE o "LOOP"** sono realizzate in tubolare di acciaio trafilato a sezione trapezoidale, sp. mm 2 CROMATE oppure verniciate a polveri epossidiche nei colori: ARGENTO, BIANCO, ANTRACITE, STONE GREY. Alla base sono situati piedini livellatori. Nella parte trasversale superiore sono predisposte per il fissaggio delle travi portanti.

**Le travi portanti** sono realizzate in tubolare di acciaio trafilato a sezione rettangolare 50 x 15 x sp 1,5 mm , verniciate a polveri epossidiche nei colori ARGENTO, BIANCO, ANTRACITE, STONE GREY.

Alle estremità sono dotate di piastre in acciaio stampato per il collegamento al traverso superiore delle gambe e per il fissaggio dei piani di lavoro.

Sono fornite complete di carter in ABS stampato atti a mascherare le viti di accoppiamento gamba/trave.

**Mobile-base:** struttura realizzata con pannelli di particelle legno sp. mm 18 nobilitati in melaminico, (Classe E1 basso contenuto di Formaldeide) disponibile nei colori: ROVERE 03, ROVERE GREY 04, NOCE PAVIA 06, STONE GREY 44, WENG' 45, ACERO TAKI 58, BIANCO BR. 69., rifinita perimetralmente con bordo melaminico mm 0,4.

Consente l'alloggiamento del PC-Tower e il cablaggio tramite le idonee aperture sulla base e sul cappello della struttura stessa . Il mobile-base è dotato di piedini livellatori.

### SCRIVANIE SINGOLE O CONDIVISE CON GAMBE A PONTE (BENCH):

**I piani di lavoro** sono realizzati con pannelli di particelle di legno sp. mm 18 (è possibile usare anche piani sp. mm 25 forniti a parte) nobilitati in melaminico (Classe E1 basso contenuto di Formaldeide ) e bordati perimetralmente in ABS mm 2 in tinta con la superficie e disponibili nei colori: ROVERE 03, ROVERE GREY 04, NOCE PAVIA 06, STONE GREY 44, WENG' 45, ACERO TAKI 58, BIANCO BR. 69.

**Le gambe a ponte "TERMINAL"** sono realizzate in tubolare di acciaio trafilato a sezione trapezoidale, sp. mm 2 verniciate a polveri epossidiche nei colori: ARGENTO, BIANCO, ANTRACITE, STONE GREY. Sono dotate alle due estremità inferiori di puntali in Nylon stampato con alloggiato il piedino livellatore.

Nella parte trasversale superiore sono predisposte per il fissaggio delle travi portanti.

**Le gambe a ponte "CENTRALI"** sono realizzate in tubolare di acciaio trafilato a sezione quadrata 50x50 x sp. 2 mm verniciate a polveri epossidiche nei colori: ARGENTO, BIANCO, ANTRACITE, STONE GREY . Sono dotate alle due estremità inferiori di puntali in Nylon stampato con alloggiato il piedino livellatore. Nella parte trasversale superiore di sezione rettangolare 100 x 50 x sp 2 mm sono predisposte per il fissaggio delle travi portanti. Sono disponibili in due tipologie: aperta o chiusa tramite pannellatura in lamiera di acciaio sp mm 1 con 1 lato fisso ed un lato ispezionabile uso " WIRE MANAGER " per il contenimento di cablaggi e relative apparecchiature ed eccedenze.

**Le travi portanti** sono realizzate in tubolare di acciaio trafilato a sezione rettangolare 50 x 15 x sp 1,5 mm , verniciate a polveri epossidiche nei colori ARGENTO, BIANCO, ANTRACITE, STONE GREY.

Alle estremità sono dotate di piastre in acciaio stampato per il collegamento al traverso superiore delle gambe e per il fissaggio dei piani di lavoro.

Sono fornite complete di carter in ABS stampato atti a mascherare le viti di accoppiamento gamba/trave.

Alla struttura metallica intera assemblata possono essere agganciati accessori sospesi quali porta cpu e canaline portacavi in lamiera di acciaio presso piegata .

### PANNELLI FRONTALI PER BENCH:

Disponibili in 3 versioni:

1) -- Pannelli di particelle di legno sp. mm 25 nobilitati in melaminico (Classe E1 basso contenuto di Formaldeide) e bordati perimetralmente in ABS mm 2 in tinta con la superficie e disponibili nei colori: ARGENTO GOLF 01, ROVERE 03, ROVERE GREY 04, NOCE PAVIA 06, STONE GREY 44, WENG' 45, ANTRACITE 55, ACERO TAKI 58, BIANCO BR. 69.

2) -- Pannelli di particelle di legno sp. mm 25 (Classe E1 basso contenuto di Formaldeide) rivestiti in tessuto POLIESTERE STRETCH IGNIFUGO (disponibile nei colori: AZZURRO SKY 320, GIALLO FRESIA 321 , 322 AMARANTO 322, VERDE BOSCO 323, GRIGIO 327, TORTORA 328, MATTONE 330, ARANCIO 331, ROSSO 332, VERDE ACIDO 333, BLU 334.

3) -- Pannello in metacrilato BIANCO sp. mm 5.

Tutti i pannelli frontali vengono ancorati nello spazio longitudinale posto al centro dei bench tramite appositi morsetti realizzati in zama presso-fusa , e sono forniti completi di profilo di copertura dello spazio stesso costruiti in plastica co-estrusa colore ARGENTO . Tale profilo ,asportabile ed ispezionabile, assolve la funzione di top access integrato. Su entrambe le facciate dei pannelli da 25 mm di spessore inserito orizzontalmente un binario di alluminio estruso idoneo per l'aggancio di accessori sospesi.

### PANNELLI FRONTALI PER SCRIVANIE CON GAMBE A PONTE:

Realizzati in pannelli di particelle di legno sp. mm 18 nobilitati in melaminico (Classe E1 basso contenuto di Formaldeide) e bordati perimetralmente in ABS mm 2 in tinta con la superficie e disponibili nei colori: ARGENTO GOLF 01, ROVERE 03, ROVERE GREY 04, NOCE PAVIA 06, STONE GREY 44, WENG' 45, ANTRACITE 55, ACERO TAKI 58, BIANCO BR. 69. I pannelli vengono ancorati sul lato frontale dei piani di lavoro mediante staffe metalliche colore ARGENTO .

Su entrambe le facciate dei pannelli da 25 mm di spessore inserito orizzontalmente un binario di alluminio estruso idoneo per l'aggancio di accessori sospesi.

### ACCESSORI:

Realizzati in metacrilato TRASPARENTE. Sono composti da PORTA-CARTA, PORTA-PENNE, PORTA-OGGETTI.

### SCIENE PER SCRIVANIE:

Realizzate in pannelli di particelle di legno sp. mm 18 nobilitati in melaminico (Classe E1 basso contenuto di Formaldeide) e bordati perimetralmente in ABS mm 2 in tinta con la superficie e disponibili nei colori: ARGENTO GOLF 01 , BIANCO BR. 69, ANTRACITE 55, STONE GREY 44.

Si fissano sulla parte inferiore del lato frontale dei piani di lavoro mediante staffe metalliche nei colori ARGENTO, BIANCO, ANTRACITE, STONE GREY.

### VASCHETTE PASSACAVI:

Realizzati in lamiera metallica sp. mm 1 verniciata a polveri epossidiche nei colori: ARGENTO, BIANCO, ANTRACITE, STONE GREY. Consente l'alloggiamento di kit elettrificazione e la raccolta di cavi in eccesso. Il montaggio avviene a sospensione sulle travi portanti delle scrivanie deskling o con gamba a ponte; Oppure per sospensione integrati ai morsetti di sostegno dei pannelli frontali nelle scrivanie in configurazione Bench .

### MOBILI DI SERVIZIO E PORTA-CPU:

Struttura realizzata con pannello di particelle legno sp. mm 18 nobilitato in melaminico, (Classe E1 basso contenuto di Formaldeide) disponibile nei colori: ARGENTO GOLF 01 , BIANCO BR. 69, ANTRACITE 55, STONE GREY 44, rifinita perimetralmente con bordo melaminico mm 0,4.

Consente l'alloggiamento del PC-Tower e il cablaggio tramite le idonee aperture sulla base della struttura stessa .

Il top è realizzato con pannello di particelle di legno sp. mm 18 nobilitato melaminico (Classe E1 basso contenuto di Formaldeide) e disponibile nei colori: ARGENTO GOLF 01, ROVERE 03, ROVERE GREY 04, NOCE PAVIA 06, STONE GREY 44, WENG' 45, ANTRACITE 55, ACERO TAKI 58, BIANCO BR. 69. I bordi perimetrali sono in ABS mm 2 in tinta con la superficie.

I frontali e la schiena sono realizzati con pannello di particelle di legno sp. mm 18 nobilitato melaminico (Classe E1 basso contenuto di Formaldeide) e disponibili nei colori: ARGENTO GOLF 01, ROVERE 03, ROVERE GREY 04, NOCE PAVIA 06, STONE GREY 44, WENG' 45, ANTRACITE 55, ACERO TAKI 58, BIANCO BR. 69, GIALLO FRESIA 11, AZZURRO SKY 32, AMARANTO 33, VERDE BOSCO 96. I bordi perimetrali sono in ABS mm 2 in tinta con la superficie. I cassetti in legno sono dotati di serratura centralizzata, le spondine sono in fibre legnose sp. mm 12 rivestite in PVC nero, il fondo è in fibra dello spessore di mm 3.

Le maniglie sono del tipo basculante nel colore in abbinamento ai frontali. Le guide scorrevoli sono del tipo in metallo con cuscinetti in nylon dotati di fine corsa in estrazione e self-closing in chiusura. I mobili di servizio e porta-CPU sono dotati di piedini livellatori e possono essere utilizzati freestanding oppure integrati come sostegno portante dei piani di lavoro , tramite l'utilizzo delle apposite staffe fornite separatamente.

### CASSETTIERE BASI O LATERALI :

Struttura realizzata con pannello di particelle legno sp. mm 18 nobilitato in melaminico, (Classe E1 basso contenuto di Formaldeide) disponibile nei colori: ARGENTO GOLF 01 , BIANCO BR. 69, ANTRACITE 55, STONE GREY 44 rifinita perimetralmente con bordo melaminico mm 0,4. I frontali e la schiena sono realizzati con pannello di particelle di legno sp. mm 18 nobilitato melaminico (Classe E1 basso contenuto di Formaldeide) e disponibili nei colori: ARGENTO GOLF 01, ROVERE 03, ROVERE GREY 04, NOCE PAVIA 06, STONE GREY 44, WENG' 45, ANTRACITE 55, ACERO TAKI 58, BIANCO BR. 69., GIALLO FRESIA 11, AZZURRO SKY 32, AMARANTO 33, VERDE BOSCO 96. I bordi perimetrali sono in ABS mm 2 in tinta con la superficie. I cassetti in legno sono dotati di serratura centralizzata, le spondine sono in fibre legnose sp. mm 12 rivestite in PVC nero, il fondo è in fibra dello spessore di mm 3. Le guide scorrevoli sono del tipo in metallo con cuscinetti in nylon dotati di fine corsa in estrazione e self - closing in chiusura.

Le cassettiere BASI O LATERALI vanno completate con top di finitura per l'accostamento ai piani di lavoro oppure utilizzate sotto i piani di lavoro come struttura portante.

Le maniglie sono del tipo basculante nel colore in abbinamento ai frontali. Le cassettiere su ruote , sono montate su rotelle piroettanti in nylon grigio di cui le due anteriori dotate di freno di sicurezza.

### CASSETTIERE SU RUOTE :

Struttura realizzata con pannello di particelle legno sp. mm 18 nobilitato in melaminico, (Classe E1 basso contenuto di Formaldeide) disponibile nei colori: ARGENTO GOLF 01 , BIANCO BR. 69, ANTRACITE 55, STONE GREY 44, GIALLO FRESIA 11, AZZURRO SKY 32, AMARANTO 33, VERDE BOSCO 96, rifinita perimetralmente con bordo melaminico mm 0,4. I frontali sono realizzati con pannello di particelle di legno sp. mm 18 nobilitato melaminico (Classe E1 basso contenuto di Formaldeide) e disponibili nei colori: ARGENTO GOLF 01, ROVERE 03, ROVERE GREY 04, NOCE PAVIA 06, STONE GREY 44, WENG' 45, ANTRACITE 55, ACERO TAKI 58, BIANCO BR. 69, GIALLO FRESIA 11, AZZURRO SKY 32, AMARANTO 33, VERDE BOSCO 96. I bordi perimetrali sono in ABS mm 2 in tinta con la superficie. I cassetti in legno sono dotati di serratura centralizzata, le spondine sono in fibre legnose sp. mm 12 rivestite in PVC nero, il fondo è in fibra dello spessore di mm 3. Le guide scorrevoli sono del tipo in metallo con cuscinetti in nylon dotati di fine corsa in estrazione e self - closing in chiusura. Le maniglie sono del tipo basculante nel colore in abbinamento ai frontali.

Le cassettiere su ruote , sono montate su rotelle piroettanti in nylon grigio di cui le due anteriori dotate di freno di sicurezza.

### STORAGE PROF. CM 80

Utilizzabili come sostegno per i piani di lavoro (con staffe da ordinare a parte) oppure come freestanding.

Sono disponibili in due tipologie:

- con cassetto estraibile standard (con serratura)

- con anta (con serratura)

Struttura realizzata con pannelli di particelle legno sp. mm 18 (per la base sp. mm 25) nobilitati in melaminico, (Classe E1 basso contenuto di Formaldeide) disponibili nei colori: ARGENTO GOLF 01 , BIANCO BR. 69, ANTRACITE 55, STONE GREY 44 rifiniti perimetralmente con bordo melaminico mm 0,4. La base poggia su piedini livellatori realizzati in nylon neri.

Il frontale è realizzato con pannello di particelle di legno sp. mm 18 nobilitato melaminico (Classe E1 basso contenuto di Formaldeide) disponibile nei colori: ARGENTO GOLF 01, ROVERE 03, ROVERE GREY 04, NOCE PAVIA 06, STONE GREY 44, WENG' 45, ANTRACITE 55, ACERO TAKI 58, BIANCO BR. 69., GIALLO FRESIA 11, AZZURRO SKY 32, AMARANTO 33, VERDE BOSCO 96. I bordi perimetrali sono in ABS mm 2 in tinta con la superficie. La maniglia verticale è realizzata in polipropilene, fornita in tinta unita in abbinamento al colore dell'anta e frontale. Il cassetto estraibile standard è costituito da ripiani realizzati con pannelli di particelle legno sp. mm 18, per la schiena sp. mm 12, nobilitati in melaminico, (Classe E1 basso contenuto di Formaldeide) disponibile nei colori ARGENTO GOLF 01, BIANCO BR. 69, ANTRACITE 55, STONE GREY 44 rifiniti perimetralmente con bordo melaminico mm 0,4.

I ripiani sono rivestiti con lamiera metallica sp. mm 1 verniciata colore argento. Sul ripiano superiore è inserita una vaschetta porta-cancelleria realizzata in materiale plastico colore argento.

Gli storage sono da completare sempre con top di finitura!

**TOPS DI FINITURA PER STORAGE e CASSETTIERE LATERALI**

Sono disponibili in due tipologie:

- A) --Singolo : per accostamento a piani profondità cm 60-80
- B) --Doppio: per accostamento a bench profondità cm 165,2

Realizzati con pannelli di particelle di legno sp. mm 18 oppure sp. mm 25 nobilitati melaminico (Classe E1 basso contenuto di Formaldeide) disponibili nei colori: ARGENTO GOLF 01, ROVERE 03, ROVERE GREY 04, NOCE PAVIA 06, STONE GREY 44, WENG' 45, ANTRACITE 55, ACERO TAKI 58, BIANCO BR. 69. I bordi perimetrali sono in ABS mm 2 in tinta con la superficie.

**TAVOLI RIUNIONE CON GAMBE A PONTE:**

I piani di lavoro sono realizzati con pannelli di particelle di legno sp. mm 18 nobilitati in melaminico (Classe E1 basso contenuto di Formaldeide) e bordati perimetralmente in ABS mm 2 in tinta con la superficie e disponibili nei colori: ROVERE 03, ROVERE GREY 04, NOCE PAVIA 06, STONE GREY 44, WENG' 45, ACERO TAKI 58, BIANCO BR. 69. I piani sono dotati di Top Access integrato, con cornice in plastica stampata colore argento e coperchio realizzato con pannello di particelle di legno sp. mm8 dello stesso colore dei piani.

**Le gambe a ponte "TERMINALI"** sono realizzate in tubolare di acciaio trafilato a sezione trapezoidale, sp. mm 2 verniciate a polveri epossidiche nei colori: ARGENTO, BIANCO, ANTRACITE, STONE GREY. Sono dotate alle due estremità inferiori di puntali in Nylon stampato con alloggiato il piedino livellatore.

Nella parte trasversale superiore sono predisposte per il fissaggio delle travi portanti.

**Le gambe a ponte "CENTRALI"** sono realizzate in tubolare di acciaio trafilato a sezione quadrata 50 x50 x sp. 2 mm verniciate a polveri epossidiche nei colori: ARGENTO, BIANCO, ANTRACITE, STONE GREY. Sono dotate alle due estremità inferiori di puntali in Nylon stampato con alloggiato il piedino livellatore.

Nella parte trasversale superiore di sezione rettangolare 100 x 50 x sp 2 mm sono predisposte per il fissaggio delle travi portanti.

Sono disponibili in due tipologie: aperta o chiusa tramite pannellatura in lamiera di acciaio sp mm 1 con 1 lato fisso ed un lato ispezionabile uso "WIRE MANAGER" per il contenimento di cablaggi e relative apparecchiature ed eccedenze.

**Le travi portanti** sono realizzate in tubolare di acciaio trafilato a sezione rettangolare 50 x 15 x sp 1,5 mm, verniciate a polveri epossidiche nei colori ARGENTO, BIANCO, ANTRACITE, STONE GREY.

Alle estremità sono dotate di piastre in acciaio stampato per il collegamento al traverso superiore delle gambe e per il fissaggio dei piani di lavoro.

Sono fornite complete di carter in ABS stampato atti a mascherare le viti di accoppiamento gamba/trave.

**SYSTEM**

**MODULI PARETINE**

Costituiti da un Telaio perimetrale in alluminio anodizzato estruso legato e reso strutturale tramite elementi trasversali di tamponamento costruiti in pannelli di particelle di legno sp. 25mm (Classe E1 basso contenuto di Formaldeide).

La configurazione dei tamponamenti per la parte al di sopra del livello del piano di lavoro (da quota 74 cm in su) prevista in 3 tipologie:

- 1) Nobilitato in melaminico sp. mm 25 disponibile nei colori: ROVERE 03, ROVERE GREY 04, NOCE PAVIA 06, STONE GREY 44, WENG' 45, ACERO TAKI 58, BIANCO BR. 69.
- 2) Rivestito in tessuto POLIESTERE STRETCH IGNIFUGO (nei colori AZZURRO SKY 320, VERDE BOSCO 323, VERDE ACIDO 333)
- 3) Metacrilato: nel colore BIANCO SATINATO sp. mm 5.

Il tamponamento della parte al di sotto del livello del piano di lavoro (da quota 20 a quota 74 cm) è sempre costruita in pannelli di particelle di legno sp. 25mm nobilitato melaminico nel colore: ARGENTO GOLF 01.

I moduli paretine possono essere utilizzati come sostegno strutturale per i piani di lavoro, e sono dotati di piedini livellatori. Trasversalmente, sono dotati di profili in plastica estrusa attrezzabili tramite sospensione di accessori nella apposita cava.

Sul traverso superiore in alluminio dei moduli stessi presente una ulteriore cava orizzontale attrezzabile (nei pannelli h cm 150 tale cava si può utilizzare per l'aggancio di pensili porta -dox.)

**PIANI DI LAVORO**

Realizzati con pannelli di particelle di legno sp. mm 25 nobilitati in melaminico, (Classe E1 basso contenuto di Formaldeide)

disponibili nei colori: ROVERE 03, ROVERE GREY 04, NOCE PAVIA 06, STONE GREY 44, WENG' 45, ACERO TAKI 58, BIANCO BR. 69, rifiniti perimetralmente con bordo in ABS mm2 in tinta con la superficie.

I piani sono dotati di Top Access integrato, con cornice in plastica stampata colore argento e coperchio realizzato con pannello di particelle di legno sp. mm8 dello stesso colore dei piani.

**GAMBE METALLICHE A CORNICE**

Realizzate con tubolare metallico a sezione mista rettangolare/quadrata mm 50 x 20 e mm 20 x 20 x spess. mm 2, verniciate a polveri epossidiche nel colore ARGENTO.

Predisposte per il fissaggio di travi portanti e dei piani. Le gambe sono collegabili alla paretina tramite un sistema di aggancio inserito nella cava del profilo perimetrale della stessa in modo da realizzare un sistema solido strutturato. Sono inoltre dotate di piedini livellatori in nylon.

**TRAVI PER GAMBE A CORNICE**

Realizzate con tubolare metallico a sezione rettangolare 30 x 20 x spess. mm 2, verniciate a polveri epossidiche nel colore ARGENTO. Predisposte per il fissaggio sulle gambe a cornice tramite angolari in Nylon stampato..

**MENSOLE PER PARETINE**

Sono realizzate con pannelli di particelle di legno sp. mm 12 nobilitati in melaminico (Classe E1 basso contenuto di Formaldeide) e bordati perimetralmente in ABS mm 2 in tinta con la superficie, disponibili nel colore ARGENTO GOLF 01. Sono dotate di barra di supporto in alluminio estruso per ancoraggio a modulo paretina.

La barra di supporto disponibile anche con lampada a Led integrata, caratteristiche da 25W a 50W variabili a seconda la lunghezza scelta (da cm 60-80-100)

**PENSILI PORTA-DOX PER PARETINE**

Disponibili a giorno o con anta basculante.

Struttura realizzata con pannello di particelle legno sp. mm 18 nobilitato in melaminico, (Classe E1 basso contenuto di Formaldeide) disponibile nel colore ARGENTO GOLF 01, rifinita perimetralmente con bordo melaminico mm 0,4.

L'anta, viene costruita con pannello di particelle di legno sp. mm 18 nobilitato melaminico e disponibili nei colori: ROVERE 03, ROVERE GREY 04, NOCE PAVIA 06, STONE GREY 44, WENG' 45, ACERO TAKI 58, BIANCO BR. 69. I bordi perimetrali sono in ABS mm 2 in tinta con la superficie. L'anta, del tipo ad apertura basculante con angolazione maggiore di 100°, completa di serratura.

Il pensile viene fissato alla cava della paretina tramite staffe metalliche sagomate.

**IMBALLO**

Tutti i componenti sono forniti smontati ed imballati con involucro pieghevole in cartone triplo, listelli di protezione perimetrale e per i riempimenti ove occorre. Gli angoli sono protetti, ove occorre, con paraspigoli anti-urto. La chiusura dell'imballo avviene mediante nastro adesivo e reggetta in nylon termosaldato.

Le cassetiere sono fornite montate, protette sui lati con angolari in polistirolo ed imballate con foglia di polietilene termoretraibile.

CARATTERISTICHE FISICO-MECCANICHE DEI PANNELLI DI PARTICELLE DI LEGNO DI SPESSORE mm 18 NOBILITATI IN MELAMINICO:		
DESCRIZIONE	VALORE MINIMO	NORMA DI RIFERIMENTO
Massa volumica	650 Kg / m <sup>3</sup> ± 10%	UNI EN 323 :1994
Umidità relativa	5 - 13%	UNI EN 322 :1994
Tolleranza spessore	± 0,3 mm	UNI EN 324-1/1994
Rigonfiamento a 24 ore	15%	UNI EN 317 :1994
Distacco strati esterni	0,8 Mpa	UNI EN 311 :2003
Flessione statica	16 Mpa	UNI EN 310 :1994
Modulo di elasticità	1600 Mpa	UNI EN 310 :1994
Estrazione viti sui bordi	> 400 N	UNI EN 320 :1994
Contenuto di formaldeide	≤ a 3,5 mg H2CO (m <sup>2</sup> x h)	UNI EN ISO 12460 - 3:2015

Emesso da Ufficio Tecnico  
 LAS MOBILI  
 Data ultima revisione:  
 GENNAIO 2018

## TECHNICAL DESCRIPTION

# 5<sup>TH</sup> ELEMENT

### EXECUTIVE DESKS WITH BRIDGE LEGS OR "LOOP and BASE-CABINET:

**The worktop** are available 2 versions: wood or glass.

The wooden surface is made with 18mm-thick melamine faced particleboard panel, (it also possible to use 25mm-thick tops supplied separately), (Class E1 low formaldehyde content) and perimetrimally edged with 2mm ABS that matches the surface top; available in the following colours: OAK 03, GREY OAK 04, PAVIA WALNUT 06, STONE GREY 44, WENGE' 45, TAKI MAPLE 58, BR. WHITE 69.

The glass surface is rear-lacquered float tempered of 10mm thick with a shiny rimmed perimeter edge, which can only be used if matched to the metal structure and anchored to the same through supports cast in inox steel. The glass surface is available in colours: BLACK 10, GREY BEIGE 72, RUBY RED 74, WHITE 79.

**The BRIDGE or "LOOP" legs** are made of 2mm trapezoidal-sectioned drawn tubular steel, CHROMED or PAINTED with epoxy powders in the following colours: SILVER, WHITE, ANTHRACITE, STONE GREY. At the base they are equipped with the levelling feet. They are pre-fitted on the upper transversal part for the attachment of the supporting beams.

**The supporting beams** are made of rectangular-sectioned drawn tubular steel 50 x 15 x 1,5 mm thick, painted with epoxy powders in colours: SILVER, WHITE, ANTHRACITE, STONE GREY.

At the ends, they are equipped with printed steel plates for the connection to the upper transversal rod of the legs and for mounting the workstation tops.

They are supplied complete with ABS carters that serve to conceal the leg/beam coupling screws.

**Base-cabinet:** Structure made of 18 mm-thick melamine faced particleboard panels (Class E1 low formaldehyde content); available in the following colours: OAK 03, GREY OAK 04, PAVIA WALNUT 06, STONE GREY 44, WENGE' 45, TAKI MAPLE 58, BR. WHITE 69., perimetrimally finished with a 0.4 mm melamine border. Used for housing PC Towers and related wiring via the opening at the base and top of the structure itself. The base-cabinet is equipped with levelling feet.

### SINGLE OR SHARED DESKS WITH BRIDGE LEGS (BENCHES):

**The workstation tops** are made with 18mm-thick melamine faced particleboard panel, (it also possible to use 25mm-thick tops supplied separately), (Class E1 low formaldehyde content) and perimetrimally edged with 2mm ABS that matches the surface top; available in the following colours: OAK 03, GREY OAK 04, PAVIA WALNUT 06, STONE GREY 44, WENGE' 45, TAKI MAPLE 58, BR. WHITE 69.

**The TERMINAL bridge legs** are made of 2mm trapezoidal-sectioned drawn tubular steel, painted with epoxy powders in the following colours: SILVER, WHITE, ANTHRACITE, STONE GREY. At the two lower ends they are equipped with printed Nylon feet that house the levelling feet.

They are pre-fitted on the upper transversal part for the attachment of the supporting beams.

**The "CENTRAL or SHARED" bridge legs** are made of square-sectioned drawn tubular steel, 50 x 50 x 2 mm-thick, painted with epoxy powders in the following colours: SILVER, WHITE, ANTHRACITE, STONE GREY. At the two lower ends they are equipped with printed Nylon feet that house a levelling foot.

At the rectangular sectioned upper transversal part, 100 x 50 x 2 mm thick, they are pre-fitted for the attachment of the supporting beams.

Two types are available: open or closed via a 1 mm-thick sheet steel panelling with 1 fixed side and one inspectionable "WIRE MANAGER" side used to house wiring, related equipment and surplus materials.

**The supporting beams** are made of rectangular-sectioned drawn tubular steel 50 x 15 x 1,5 mm thick, painted with epoxy powders in colours: SILVER, WHITE, ANTHRACITE, STONE GREY.

At the ends, they are equipped with printed steel plates for the connection to the upper transversal rod of the legs and for mounting the workstation tops.

They are supplied complete with ABS carters that serve to conceal the leg/beam coupling screws.

Hanging accessories, including PC tower stands and wire conduits made of press-folded sheet steel can be fastened to the complete metal structure.

### FRONT PANELS FOR BENCHES:

Available in three versions:

1) - 25mm-thick melamine faced particleboard panel (Class E1 low formaldehyde content) that are perimetrimally bordered with 2mm-thick ABS that matches the top surface; available in the following colours: GOLF SILVER 01, OAK 03, GREY OAK 04, PAVIA WALNUT 06, STONE GREY 44, WENGE' 45, ANTHRACITE 55, TAKI MAPLE 58, BR. WHITE 69.

2) - 25mm-thick wood-particle panel (Class E1 low formaldehyde content) covered in FIRE-RETARDANT STRETCH POLYESTER FABRIC (available in the following colours: SKY BLUE 320, FREESIA YELLOW 321, AMARANTH 322, WOOD GREEN 323, GREY 327, GREY BEIGE 328, BRICK RED 330, ORANGE 331, RED 332, ACID GREEN 333, BLUE 334)

3) - 5mm-thick WHITE methacrylate panel.

All front panels are anchored in the longitudinal space located at the centre of the benches using of special compression-molded zinc alloy clamps, and they are supplied complete with a covering profile for the space and made of SILVER co-extruded plastic. This removable and inspectionable profile performs the integrated top access function.

On both sides of the 25mm-thick panels there is an extruded aluminum track, suitable for hanging accessories.

### FRONT PANELS FOR DESKS WITH BRIDGE LEGS:

Made of 18mm-thick melamine faced particleboard panels (Class E1 low formaldehyde content) and perimetrimally edged with 2mm ABS that matches the top surface; available in the following colours: GOLF SILVER 01, OAK 03, GREY OAK 04, PAVIA WALNUT 06, STONE GREY 44, WENGE' 45, ANTHRACITE 55, TAKI MAPLE 58, BR. WHITE 69.

The panels are anchored on the front of the worktops using metal brackets in colours: SILVER, WHITE, ANTHRACITE, STONE GREY.

On both sides of the 25mm-thick panels there is a horizontal extruded aluminium track, suitable for attaching hanging accessories.

### ACCESSORIES:

Made of TRANSPARENT methacrylate. They are composed of a PAPER TRAY, PEN-HOLDER, COURTESY TRAY.

### BACK PANELS FOR DESKS AND WORKSTATION:

Made of 18mm-thick melamine faced particle boards (Class E1 low formaldehyde content) and perimetrimally edged in 2mm ABS that matches the top surface; available in colours: GOLF SILVER 01, BR. WHITE 69, ANTHRACITE 55, STONE GREY 44.

They are secured to the lower part of the front side of the work tops using SILVER-coloured metal brackets.

### CABLE-TRAYS:

Made of 1mm-thick sheet metal, painted in colours: SILVER, WHITE, ANTHRACITE, STONE GREY with epoxy powders; used for housing electrification kits and excess cables.

They are hung on the supporting beams of deskings desks or those with bridge legs; or hung, attached to the support clamps of the front panels of the Bench configuration desks.

### SERVICE UNITS AND CPU-HOLDER

Structure made of 18 mm-thick melamine faced particleboard panels (Class E1 low formaldehyde content); available in GOLF SILVER 01, BR. WHITE 69, ANTHRACITE 55, STONE GREY 44.

, perimetrimally finished with a 0.4 mm melamine border. Used for housing PC Towers and related wiring via the opening at the base of the structure itself.

The top is made of 18mm-thick melamine faced particleboard panels (Class E1 low formaldehyde content) and is available in the following colours: GOLF SILVER 01, OAK 03, GREY OAK 04, PAVIA WALNUT 06, STONE GREY 44, WENGE' 45, ANTHRACITE 55, TAKI MAPLE 58, BR. WHITE 69. The perimetric borders are made of 2mm-thick ABS that is the same colour as the top surface.

The front and the back are made of 18mm-thick melamine faced particleboard panels (Class E1 low formaldehyde content) and are available in the following colours: GOLF SILVER 01, OAK 03, GREY OAK 04, PAVIA WALNUT 06, STONE GREY 44, WENGE' 45, ANTHRACITE 55, TAKI MAPLE 58, BR. WHITE 69, FREESIA YELLOW 11, SKY BLUE 32, AMARANTH 33, WOOD GREEN 96. The perimetric borders are made of 2mm-thick ABS that is the same colour as the top surface.

The wood drawers are fitted with a central lock; the sides of the drawers are made of 12 mm wood fibre boards covered by black PVC and the drawer bottoms are made of 3mm-thick fibreboard.

The handles are of the pivoting type in color in combination with the front. The sliding guides are made out of metal and have nylon buffers fitted with limit switches during opening and self-closing limit switches during closing.

The cabinets and PC towers are fitted with levelling feet and can be freestanding or integrated as supports for the workstation tops using special brackets that are supplied separately.

### BASE AND LATERAL PEDESTALS:

Structure made of 18 mm-thick melamine faced particleboard panels (Class E1 low formaldehyde content); available in GOLF SILVER 01, BR. WHITE 69, ANTHRACITE 55, STONE GREY 44 perimetrimally finished with a 0.4 mm melamine border. The front and back are made of 18 mm-thick melamine faced particleboard panels (Class E1 low formaldehyde content) and available in colours: GOLF SILVER 01, OAK 03, GREY OAK 04, PAVIA WALNUT 06, STONE GREY 44, WENGE' 45, ANTHRACITE 55, TAKI MAPLE 58, BR. WHITE 69, FREESIA YELLOW 11, SKY BLUE 32, AMARANTH 33, WOOD GREEN 96. The perimetric borders are made of 2mm ABS that matches the top surface. The wood drawers are fitted with a central lock; the sides of the drawers are made of 12 mm wood fibreboards covered by black PVC and the drawer bottoms are made of 3mm-thick fibreboard. The sliding guides are made out of metal and have nylon buffers fitted with limit switches during opening and self-closing limit switches during closing.

The BASE OR LATERAL drawer units are completed with a finished top and placed next to the worktop or used under the worktop as a supporting structure.

The handles are of the pivoting type in color in combination with the front.

### PEDESTALS ON WHEELS:

Structure made of 18 mm-thick melamine faced particleboard panels (Class E1 low formaldehyde content); available in GOLF SILVER 01, BR. WHITE 69, ANTHRACITE 55, STONE GREY 44, FREESIA YELLOW 11, SKY BLUE 32, AMARANTH 33, WOOD GREEN 96, perimetrimally finished with a 0.4 mm melamine border. The front are made of 18 mm-thick melamine faced particleboard panels (Class E1 low formaldehyde content) and available in colours: GOLF SILVER 01, OAK 03, GREY OAK 04, PAVIA WALNUT 06, STONE GREY 44, WENGE' 45, ANTHRACITE 55, TAKI MAPLE 58, BR. WHITE 69, FREESIA YELLOW 11, SKY BLUE 32, AMARANTH 33, WOOD GREEN 96. The perimetric borders are made of 2mm ABS that matches the top surface. The wood drawers are fitted with a central lock; the sides of the drawers are made of 12 mm wood fibreboards covered by black PVC and the drawer bottoms are made of 3mm-thick fibreboard. The sliding guides are made out of metal and have nylon buffers fitted with limit switches during opening and self-closing limit switches during closing.

The handles are of the pivoting type in color in combination with the front. The mobile pedestals are mounted on grey nylon pivoting wheels and the two front wheels are equipped with a safety brake.

### STORAGE DEEP 80CMS

Can be used as under-top support (with stirrups that must be ordered separately) or free-standing.

The units are available in three categories:

- with a **standard drawer (with lock)**

- with **door (with lock)**

The structure is made of melamine woodychipboard 18 mm thick (25 mm thick base), (E1 class, low contents of formaldehyde) available in GOLF SILVER 01, BR. WHITE 69, ANTHRACITE 55, STONE



GREY 44, with melamine edge mm 0.4. The base rests on levelling feet made of black nylon.  
The front panel is made of melamine woodychipboard 18 mm thick (E1 class, low contents of formaldehyde) available in: GOLF SILVER 01, OAK 03, GREY OAK 04, PAVIA WALNUT 06, STONE GREY 44, WENGE' 45, ANTHRACITE 55, TAKI MAPLE 58, BR. WHITE 69, FREESIA YELLOW 11, SKY BLUE 32, AMARANTH 33, WOOD GREEN 96. The edge is made of 2 mm thick ABS of the same colour as the surface.  
Vertical handle, made of polypropylene, supplied to match the color of the door and front.  
**The standard drawer** is composed of shelves made of melamine woodychipboard 18 mm thick, the back is made of 12 mm thick melamine woodychipboard, (E1 class, low contents of formaldehyde) available in GOLF SILVER 01 and WHITE BRIL 69, with melamine edge 0.4 mm.  
The shelves are covered with metal plate 1 mm thick silver varnished. The top shelf is equipped with stationary holder made of silver-colour plastic.  
The storage units must always be completed with finishing top!

#### FINISHING TOPS FOR STORAGE UNITS and LATERAL PEDESTAL

Are available in two categories:

- A) --Single : for matching tops cm 60-80 deep  
B) --Double: for matching bench cm 165,2 deep

The tops are made of melamine woodychipboard 18 or 25 mm thick (E1 class, low contents of formaldehyde) available in: OAK 03, GREY OAK 04, PAVIA WALNUT 06, STONE GREY 44, WENGE' 45, TAKI MAPLE 58, BR. WHITE 69. The edge is made of 2 mm thick ABS of the same colour as the surface.

#### MEETING TABLES WITH BRIDGE LEGS:

**The workstation tops** are made with 18mm-thick melamine faced particleboard (Class E1 low formaldehyde content) and perimetrically bordered with 2mm ABS that matches the top surface; available in the following colours: OAK 03, GREY OAK 04, PAVIA WALNUT 06, STONE GREY 44, WENGE' 45, TAKI MAPLE 58, BR. WHITE 69. The workstation tops are equipped with integrated Top Access made of printed plastic that is the same colour as the top.

**The TERMINAL bridge legs** are made of 2mm trapezoidal-sectioned drawn tubular steel, painted with epoxy powders in the following colours: SILVER, WHITE, ANTHRACITE, STONE GREY. At the two lower ends they are equipped with printed Nylon feet that house the levelling feet.

They are pre-fitted on the upper transversal part for the attachment of the supporting beams.

**The "CENTRAL or SHARED" bridge legs** are made of square-sectioned drawn tubular steel, 50 x50 x 2 mm-thick, painted with epoxy powders in the following colours: SILVER, WHITE, ANTHRACITE, STONE GREY. At the two lower ends they are equipped with printed Nylon feet that house a levelling foot.

At the rectangular sectioned upper transversal part, 100 x 50 x 2 mm thick, they are pre-fitted for the attachment of the supporting beams.

Two types are available: open or closed via a 1 mm-thick sheet steel panelling with 1 fixed side and one inspectionable "WIRE MANAGER" side used to house wiring, related equipment and surplus materials.

**The supporting beams** are made of rectangular-sectioned drawn tubular steel 50 x 15 x 1,5 mm thick, painted with epoxy powders in colours: SILVER, WHITE, ANTHRACITE, STONE GREY.

At the ends, they are equipped with printed steel plates for the connection to the upper transversal rod of the legs and for mounting the workstation tops.

They are supplied complete with ABS carter that serve to conceal the leg/beam coupling screws.

Hanging accessories, including PC tower stands and wire conduits made of press-folded sheet steel can be fastened to the complete metal structure.

#### SYSTEM

##### MODULAR PARTITION PANELS

Composed of an extruded anodized aluminium perimetric frame, secured and assembled using side closure panels made of 25mm-thick particleboard (Class E1 low formaldehyde content).

For the part above the work top, the side panels come in three types (74cm and above):

- 1) 25mm-thick melamine faced; available in colours: OAK 03, GREY OAK 04, PAVIA WALNUT 06, STONE GREY 44, WENGE' 45, TAKI MAPLE 58, BR. WHITE 69.
- 2) Covered in covered in FIRE-RETARDANT STRETCH POLYESTER FABRIC (available in the following colours: SKY BLUE 320, WOOD GREEN 323, ACID GREEN 333)
- 3) Methacrylate: in SATINED WHITE 5 mm-thick

The side closure panels for below the worktop (from 20 to 74 cm) are also made of 25mm-thick melamine faced particleboard, in GOLF SILVER 01.

The modular partition panels can be used as structural supports for the work tops and they are equipped with levelling feet. Transversely, they have extruded plastic profiles from which accessories can be hung in the recess provided.

On the aluminium upper traversal part of the modules themselves there is another horizontal recess for hanging accessories (in h 1500 panels this recess can be used for hanging document trays)

**THE WORKSTATION TOPS** are made with 25mm-thick melamine face particleboards (Class E1 low formaldehyde content) available in the following colours: OAK 03, GREY OAK 04, PAVIA WALNUT 06, STONE GREY 44, WENGE' 45, TAKI MAPLE 58, BR. WHITE 69., perimetrically finished with a 2mm ABS border that matches the top surface. All the work tops are equipped with integrated Top Access, made of silver printed plastic frame and cover made of 8mm thick. melamine faced particleboard panel in the same colour as the worktop surface.

##### METAL FRAME LEGS

Made with mixed rectangular/square-sectioned tubular metal, 50 mm x 20 mm and 20 x 20 x 2mm-thick, painted SILVER, with epoxy powders.

Pre-set for attaching supporting beams and tops. The legs can be connected to the partition wall via a coupling system located inside the perimetric profile recess in order to achieve a solid structure. They are also fitted with nylon levelling feet.

##### BEAMS FOR FRAME LEGS

Made with a rectangular-sectioned tubular metal 30 x 20 x 2mm-thick, painted SILVER with epoxy powders. Pre-set for mounting on the frame legs using printed nylon connection angles.

##### SHELVES FOR MODULAR PARTITION PANELS

They are made with 12 mm-thick melamine faced particleboard panels (Class E1 low formaldehyde content) and perimetrically edged with 2mm ABS that matches the top surface; available in GOLF SILVER 01. They are equipped with extruded aluminium support bars for anchorage to the modular partition wall.

The support bar is also available with an integrated Led light (from 25W till 50W) whose characteristics may vary according to the length chosen (from 60-80-100 cm).

##### SUSPENDED STORAGE CABINET FOR PARTITION PANELS

Available in either open style or with and up-and-over door.

The structure is made with an 18 mm-thick melamine faced particleboard panel (Class E1 low formaldehyde content), available in GOLF SILVER 01, perimetrically finished with a 0.4 mm melamine border. The door is made with an 18 mm-thick melamine faced particleboard panel; available in colours: OAK 03, GREY OAK 04, PAVIA WALNUT 06, STONE GREY 44, WENGE' 45, TAKI MAPLE 58, BR. WHITE 69. The perimetric edges are made of 2 mm ABS that is the same colour as the top surface. The up-and-over door, which opens at more than a 100° angle, comes complete with a lock. The unit is secured to the partition recess using shaped metal brackets.

##### PACKAGING

All the components are disassembled and packed when supplied, and have paper triple type folding packaging, fillets for the perimetric protection and for the fillings up, where needed. The corners are protected, where needed, through shock resistant edges protector. The packing closure occurs through sticky tape and welded nylon strap.

Pedestals are assembled, when supplied, protected through polystyrene angle bars on the sides and packed using thermo-retractable polyethylene leave when provided.

PHYSICAL-MECHANICAL CHARACTERISTICS OF 18 MM THICK PARTICLEBOARD PANELS, MELAMINE-FACED:		
DESCRIPTION	MINIMUM VALUE	STANDARD NUMBERS
Volume Mass	650 Kg / m <sup>3</sup> ± 10%	UNI EN 323 :1994
Relative Humidity	5 - 13%	UNI EN 322 :1994
Thickness Allowance	± 0,3 mm	UNI EN 324-1/1994
24 hour Swelling	15%	UNI EN 317 :1994
External Surfaces Detachment	0,8 Mpa	UNI EN 311 :2003
Static Flexure	16 Mpa	UNI EN 310 :1994
Elastic Modulus	1600 Mpa	UNI EN 310 :1994
Edge Screws Extraction	> 400 N	UNI EN 320 :1994
Formaldehyde Content	≤ a 3,5 mg H2CO (m <sup>2</sup> x h)	UNI EN ISO 12460 - 3:2015

Released by the Technical Office  
of LAS MOBILI  
last revision date:  
JANUARY 2018

# INDICE DEI CODICI

## codes index

\* = INDICARE IL CODICE FINITURA  
\* complete with finish code

INDICE DEI CODICI / codes index  
Mod. 5th ELEMENT

CODICE code	DESCRIZIONE description			PAG. page	PREZZO price
114 956 *	CUSCINO PER CASSETTIERE SU RUOTE CAT.F cushion for pedestals on wheels CAT.F			58	€ 51,00
152 266 *	PENSILE PORTA-DOX A GIORNO L.60 open suspended storage cabinet w 60 cms			50	€ 56,00
152 267 *	PENSILE PORTA-DOX L.60 CON 1 ANTA LEGNO BASCULANTE E SERRATURA suspended storage cabinet w 60 cms with 1 wooden door and lock			50	€ 190,00
152 268 *	SOSTEGNO PER PENSILI PORTA-DOX (OPTIONAL) support for suspended storage cabinets (optional)			50	€ 29,00
152 274 *	TOP PER 2 CASSETTIERE LATERALI O STORAGE L.42 x p.165,2 top for 2 lateral pedestals or storage w 42 x d 165,2 cms	25 mm		60-62	€ 51,00
152 276 *	TOP PER 2 MOBILI LATERALI L.46 x p.165,2 top for 2 lateral cabinets w 46 x d 165,2 cms	25 mm		56	€ 53,00
152 331 *	SCHERMO FRONTALE IN METACRILATO BIANCO L.60 white methacrylate front screen w 60			30	€ 60,00
152 332 *	SCHERMO FRONTALE IN METACRILATO BIANCO L.80 white methacrylate front screen w 80			30	€ 87,00
152 348 *	VASCETTA PASSA-CAVI PER TOP ACCESS cable-tray for top access			63	€ 29,00
152 349 *	BASE PER LAMPADA base for lamp			63	€ 55,00
152 351 *	PORTA-PENNE pen-holder			22-51	€ 30,00
152 352 *	PORTA-OGGETTI object-holder			22-51	€ 54,00
152 353 *	KIT 2 PORTA-CARTA L.35 set of 2 paper-holder w 35 cms			22-51	€ 69,00
152 358 *	KIT 6 MANIGLIE set of 6 handles			58	€ 38,00
152 361 *	MORSETTO PER ANCORAGGIO LAMPADA A PIANI DI LAVORO clamp for fixing lamp to worktop			63	€ 38,00
152 362 *	BRACCIO SNODATO PORTA-VIDEO CON MORSETTO PER ANCORAGGIO A PIANI DI LAVORO articulated rotating video stand arm + clamp for fixing to worktops			63	€ 263,00
152 382 *	PIANO SCRIVANIA L.120 x p.60 desktop w 120 x d 60 cms	25 mm	SENZA TOP ACCESS without top access	34-45	€ 54,00
152 383 *	PIANO SCRIVANIA L.140 x p.60 desktop w 140 x d 60 cms	25 mm	SENZA TOP ACCESS without top access	34-45	€ 60,00
152 384 *	PIANO SCRIVANIA L.160 x p.60 desktop w 160 x d 60 cms	25 mm	SENZA TOP ACCESS without top access	34-45	€ 66,00
152 385 *	PIANO SCRIVANIA L.180 x p.60 desktop w 180 x d 60 cms	25 mm	SENZA TOP ACCESS without top access	34-45	€ 74,00
152 386 *	PIANO SCRIVANIA L.120 x p.60 desktop w 120 x d 60 cms	25 mm	CON TOP ACCESS with top access	45	€ 93,00
152 387 *	PIANO SCRIVANIA L.140 x p.60 desktop w 140 x d 60 cms	25 mm	CON TOP ACCESS with top access	45	€ 102,00
152 388 *	PIANO SCRIVANIA L.160 x p.60 desktop w 160 x d 60 cms	25 mm	CON TOP ACCESS with top access	45	€ 109,00
152 389 *	PIANO SCRIVANIA L.180 x p.60 desktop w 180 x d 60 cms	25 mm	CON TOP ACCESS with top access	45	€ 116,00
152 392 *	PIANO SCRIVANIA L.120 x p.80 desktop w 120 x d 80 cms	25 mm	SENZA TOP ACCESS without top access	34-45	€ 64,00
152 393 *	PIANO SCRIVANIA L.140 x p.80 desktop w 140 x d 80 cms	25 mm	SENZA TOP ACCESS without top access	34-45	€ 75,00
152 394 *	PIANO SCRIVANIA L.160 x p.80 desktop w 160 x d 80 cms	25 mm	SENZA TOP ACCESS without top access	34-45	€ 84,00
152 395 *	PIANO SCRIVANIA L.180 x p.80 desktop w 180 x d 80 cms	25 mm	SENZA TOP ACCESS without top access	34-45	€ 92,00
152 396 *	PIANO SCRIVANIA L.120 x p.80 desktop w 120 x d 80 cms	25 mm	CON TOP ACCESS with top access	45	€ 108,00
152 397 *	PIANO SCRIVANIA L.140 x p.80 desktop w 140 x d 80 cms	25 mm	CON TOP ACCESS with top access	45	€ 117,00
152 398 *	PIANO SCRIVANIA L.160 x p.80 desktop w 160 x d 80 cms	25 mm	CON TOP ACCESS with top access	45	€ 127,00
152 399 *	PIANO SCRIVANIA L.180 x p.80 desktop w 180 x d 80 cms	25 mm	CON TOP ACCESS with top access	45	€ 138,00
152 404 *	PIANO WORKSTATION L.160 x p.100 DX right workstation top w 160 x d 100 cms	25 mm	CON TOP ACCESS with top access	45	€ 150,00
152 405 *	PIANO WORKSTATION L.160 x p.100 SX left workstation top w 160 x d 100 cms	25 mm	CON TOP ACCESS with top access	45	€ 150,00
152 415 *	PIANO TERMINALE PER BENCH PROF. CM 80+80 terminal desktop for bench deep 80+80 cms	25 mm		34	€ 87,00
152 422 *	TOP PER MOBILE SOTTOPIANO L.80 x p.46,2 top for undertop cabinet w 80 x d 46,2 cms	25 mm		56	€ 31,00
152 425 *	TOP PER MOBILE SOTTOPIANO L.80 x p.46,2 top for undertop cabinet w 80 x d 46,2 cms	25 mm	CON VENATURA TRASVERSALE with transversal wood veining	56	€ 31,00
152 430 *	STAFFA DI COLLEGAMENTO PIANI stirrup for fixing tops			46	€ 19,00
152 431 *	STAFFA stirrup			46	€ 19,00
152 433 *	ALLUNGO L.80 x p.60 extension w 80 x d 60 cms	25 mm	CON VENATURA TRASVERSALE with transversal wood veining	46	€ 31,00
152 434 *	ALLUNGO L.80 x p.60 extension w 80 x d 60 cms	25 mm	CON VENATURA TRASVERSALE with transversal wood veining	46	€ 39,00
152 435 *	ALLUNGO L.100 x p.60 extension w 100 x d 60 cms	25 mm	CON VENATURA TRASVERSALE with transversal wood veining	46	€ 46,00
152 441 *	STORAGE STANDARD PROF. 80 X H.71 standard storage deep 80 x h.71 cms			61	€ 448,00
152 443 *	STORAGE STANDARD PROF. 80 X H.109,3 standard storage deep 80 x h.109,3 cms			61	€ 581,00
152 448 *	TOP PER CASSETTIERA PROF. CM 60 top for pedestal deep 60 cms	25 mm		60	€ 21,00
152 449 *	TOP PER CASSETTIERA O STORAGE PROF. CM 80 top for pedestal or storage deep 80 cms	25 mm		60-62	€ 28,00
152 450 *	2 COPERTURE LATERALI PER STORAGE 2 side covers for storage			62	€ 85,00
152 454 *	MOBILE DI SERVIZIO L.140 TERMINALE DX O SX (CON 1 ANTA SCORREVOLE E VANO A GIORNO) right or left terminal service unit w 140 cms (with 1 sliding door and open compartment)			15-52	€ 264,00
152 457 *	MOBILE DI SERVIZIO L.140 CENTRALE (CON 2 ANTE SCORREVOLI E 2 VANI A GIORNO) central service unit w 140 cms (with 2 sliding doors and 2 open glove compartments in double-side)			52	€ 335,00
152 458 *	PORTA-CPU CENTRALE PER POSTAZIONI CONTRAPPOSTE central CPU-holder for 2 opposite stationing			53	€ 125,00

\* = INDICARE IL CODICE FINITURA  
= complete with finish code

INDICE DEI CODICI / codes index  
Mod. 5th ELEMENT

CODICE code	DESCRIZIONE description		PAG. page	PREZZO price
152 463 *	MOBILE BASSO L.80 CON 2 ANTE LEGNO CON SERRATURA low cabinet w 80 cms with 2 wooden doors with lock		55	€ 161,00
152 468 *	PORTA-CPU CENTRALE PER POSTAZIONI AFFIANCATE central CPU-holder for 2 side by side stationing		53	€ 116,00
152 473 *	SCHIENA PER SCRIVANIA L.120 modesty panel for desk w 120 cms		21	€ 35,00
152 474 *	SCHIENA PER SCRIVANIA L.140 modesty panel for desk w 140 cms		21	€ 37,00
152 476 *	SCHIENA PER SCRIVANIA O WORKSTATION L.180 modesty panel for desk or workstation w 180 cms		21	€ 40,00
152 477 *	SCHIENA PER SCRIVANIA L.180 modesty panel for desk w 180 cms		21	€ 43,00
152 483 *	PANNELLO FRONTALE L.120 front panel w 120 cms	MELAMINICO melamine	22	€ 60,00
152 484 *	PANNELLO FRONTALE L.140 front panel w 140 cms	MELAMINICO melamine	22	€ 65,00
152 485 *	PANNELLO FRONTALE L.160 front panel w 160 cms	MELAMINICO melamine	22	€ 70,00
152 486 *	PANNELLO FRONTALE L.180 front panel w 180 cms	MELAMINICO melamine	22	€ 75,00
152 493 *	PANNELLO FRONTALE L.120 front panel w 120 cms	TESSUTO fabric	22	€ 189,00
152 494 *	PANNELLO FRONTALE L.140 front panel w 140 cms	TESSUTO fabric	22	€ 200,00
152 495 *	PANNELLO FRONTALE L.160 front panel w 160 cms	TESSUTO fabric	22	€ 216,00
152 496 *	PANNELLO FRONTALE L.180 front panel w 180 cms	TESSUTO fabric	22	€ 232,00
152 602 *	MOBILE DI SERVIZIO L.140 CENTRALE CON ANTINE SCORREVOLI E PORTA-CPU BIFACCIALI+VANO A GIORNO central service unit w 140 cms with sliding doors and CPU-holder in double-sides + open glove compartment		53	€ 357,00
152 616 *	STORAGE CON ANTA DX CON SERRATURA PROF. 80 X H.71 storage with right wooden door with lock deep 80 x h.71 cms		61	€ 164,00
152 617 *	STORAGE CON ANTA SX CON SERRATURA PROF. 80 X H.71 storage with left wooden door with lock deep 80 x h.71 cms		61	€ 164,00
152 618 *	STORAGE CON ANTA DX CON SERRATURA PROF. 80 X H.109,3 storage with right wooden door with lock deep 80 x h.109,3 cms		61	€ 221,00
152 619 *	STORAGE CON ANTA SX CON SERRATURA PROF. 80 X H.109,3 storage with left wooden door with lock deep 80 x h.109,3 cms		61	€ 221,00
152 621 *	STORAGE CON ANTA DX CON SERRATURA PROF. 80 X H.109,3 storage with right wooden door with lock deep 80 x h.109,3 cms		61	€ 229,00
152 622 *	STORAGE CON ANTA SX CON SERRATURA PROF. 80 X H.109,3 storage with left wooden door with lock deep 80 x h.109,3 cms		61	€ 229,00
152 682 *	VASCHETTA PASSACAVI PER SCRIVANIE SINGOLE L.100 cable tray for single desks w 100 cms		37	€ 21,00
152 683 *	VASCHETTA PASSACAVI PER SCRIVANIE SINGOLE L.120 cable tray for single desks w 120 cms		37	€ 26,00
152 684 *	VASCHETTA PASSACAVI PER SCRIVANIE SINGOLE L.140 cable tray for single desks w 140 cms		37	€ 32,00
152 685 *	VASCHETTA PASSACAVI PER SCRIVANIE SINGOLE L.160 cable tray for single desks w 160 cms		37	€ 39,00
152 686 *	VASCHETTA PASSACAVI PER SCRIVANIE SINGOLE L.180 cable tray for single desks w 180 cms		37	€ 45,00
152 687 *	VASCHETTA PASSACAVI PER SCRIVANIE SINGOLE L.200 cable tray for single desks w 200 cms		37	€ 53,00
152 688 *	VASCHETTA PASSACAVI PER SCRIVANIE SINGOLE L.220 cable tray for single desks w 220 cms		37	€ 57,00
152 699 *	KIT CANALINE PASSACAVI PER SISTEMA PARETINE (SU PIANI 120-140) set of cable trays for panel system (on tops 120-140)		49	€ 55,00
152 700 *	KIT CANALINE PASSACAVI PER SISTEMA PARETINE (SU PIANI 160-180) set of cable trays for panel system (on tops 160-180)		49	€ 63,00
152 701 *	SALITA PASSACAVI H.39 PER SISTEMA PARETINE rising cable tray h.39 cms for panel system		49	€ 30,00
152 704 *	MENSOLA L.60 shelf w 60 cms		49	€ 33,00
152 706 *	MENSOLA L.80 shelf w 80 cms		49	€ 40,00
152 708 *	MENSOLA L.100 shelf w 100 cms		49	€ 49,00
152 715 *	MENSOLA L.60 CON LAMPADA A LED shelf w 60 cms with led lamp		49	€ 133,00
152 759 *	KIT 4 PASSACAVI Ø 60 mm PER PANNELLI PARETINE set of 4 cable-ways Ø 60 mm for partition panels		49	€ 18,00
152 764 *	CASSETTIERA BASE O LATERALE 4 CASSETTI (PROF. CM 60) (CON CHIUSURA AMMORTIZZATA) base or lateral pedestal with 4 drawers (deep 60 cms) (with soft-close)	CASSETTI IN LEGNO wooden drawers	59	€ 273,00
152 765 *	MOBILE DI SERVIZIO L.100 TERMINALE DX O SX (CON CASSETTI, ANTINA E PORTA-CPU) (CON CHIUSURA AMMORTIZZATA) right or left terminal service unit w 100 cms (with drawers, door and CPU-holder) (with soft-close)		52	€ 347,00
152 769 *	CLASSIFICATORE FREE-STANDING CON SERRATURA (CON CHIUSURA AMMORTIZZATA) free-standing file-pedestal with lock (with soft-close)		54	€ 204,00
152 775 *	CASSETTIERA BASE O LATERALE CON 1 CLASSIFICATORE (PROF. CM 60) (CON CHIUSURA AMMORTIZZATA) base or lateral pedestal with 1 file-drawer (deep 60 cms) (with soft-close)	CASSETTI IN LEGNO wooden drawers	59	€ 287,00
152 776 *	CASSETTIERA BASE O LATERALE 4 CASSETTI (PROF. CM 80) (CON CHIUSURA AMMORTIZZATA) base or lateral pedestal with 4 drawers (deep 80 cms) (with soft-close)	CASSETTI IN LEGNO wooden drawers	59	€ 282,00
152 777 *	CASSETTIERA BASE O LATERALE CON 1 CLASSIFICATORE (PROF. CM 80) (CON CHIUSURA AMMORTIZZATA) base or lateral pedestal with 1 file-drawer (deep 80 cms) (with soft-close)	CASSETTI IN LEGNO wooden drawers	59	€ 302,00
152 778 *	MOBILE DI SERVIZIO L.120 CON 3 CASSETTI E 1 ANTA DX (CON CHIUSURA AMMORTIZZATA) service unit w 120 cms with 3 drawers and 1 right wooden door (with soft-close)		15-52	€ 347,00
152 779 *	MOBILE DI SERVIZIO L.120 CON 3 CASSETTI E 1 ANTA SX (CON CHIUSURA AMMORTIZZATA) service unit w 120 cms with 3 drawers and 1 left wooden door (with soft-close)		15-52	€ 347,00
152 780 *	CASSETTIERA SU RUOTE 3 CASSETTI (CON SERRATURA) (CON CHIUSURA AMMORTIZZATA) mobile pedestal with 3 drawers (with lock) (with soft-close)	CASSETTI IN LEGNO wooden drawers	57	€ 204,00
152 781 *	CASSETTIERA SU RUOTE 3 CASSETTI (CON SERRATURA) (CON CHIUSURA AMMORTIZZATA) mobile pedestal with 3 drawers (with lock) (with soft-close)	CASSETTI IN METALLO metal drawers	57	€ 341,00
152 782 *	CASSETTIERA-CLASSIFICATORE SU RUOTE (CON SERRATURA) (CON CHIUSURA AMMORTIZZATA) mobile pedestal with file-drawer (with lock) (with soft-close)	CASSETTI IN LEGNO wooden drawers	57	€ 226,00
152 783 *	CASSETTIERA-CLASSIFICATORE SU RUOTE (CON SERRATURA) (CON CHIUSURA AMMORTIZZATA) mobile pedestal with file-drawer (with lock) (with soft-close)	CASSETTI IN METALLO metal drawers	57	€ 333,00
152 784 *	CASSETTIERA SU RUOTE 3 CASSETTI CON SERRATURA + 1 PORTA-CANCELLERIA (CHIUSURA AMMORTIZZATA) Pedestal on wheels 3 drawers with lock + 1 stationery-drawer (with soft-close)	CASSETTI IN LEGNO wooden drawers	57	€ 247,00
152 785 *	CASSETTIERA SU RUOTE 3 CASSETTI CON SERRATURA + 1 PORTA-CANCELLERIA (CHIUSURA AMMORTIZZATA) Pedestal on wheels 3 drawers with lock + 1 stationery-drawer (with soft-close)	CASSETTI IN METALLO metal drawers	57	€ 384,00

5<sup>TH</sup> ELEMENT

\* = INDICARE IL CODICE FINITURA  
 \* complete with finish code

INDICE DEI CODICI / codes index  
 Mod. 9th ELEMENT

CODICE code	DESCRIZIONE description		PAG. page	PREZZO price
152 786 *	MOBILE DI SERVIZIO L.100 CENTRALE (CON CASSETTO E PORTA-CPU BIFACCIALI) (CON CHIUSURA AMMORTIZZATA) central service unit w 100 cms (with drawer and CPU-holder in double -side) (with soft-close)		52	€ 369,00
152 790 *	MODULO PARETINA CIECO L.80 x H.111 blind module w 80 x h 111	MELAMINICO melamine	43	€ 121,00
152 792 *	MODULO PARETINA CIECO L.80 x H.111 blind module w 80 x h 111	MELAMINICO melamine	43	€ 138,00
152 794 *	MODULO PARETINA CIECO L.100 x H.111 blind module w 100 x h 111	MELAMINICO melamine	43	€ 153,00
152 795 *	MODULO PARETINA CIECO L.120 x H.111 blind module w 120 x h 111	MELAMINICO melamine	43	€ 167,00
152 796 *	MODULO PARETINA CIECO L.140 x H.111 blind module w 140 x h 111	MELAMINICO melamine	43	€ 188,00
152 797 *	MODULO PARETINA CIECO L.160 x H.111 blind module w 160 x h 111	MELAMINICO melamine	43	€ 201,00
152 798 *	MODULO PARETINA CIECO L.180 x H.111 blind module w 180 x h 111	MELAMINICO melamine	43	€ 214,00
152 800 *	MODULO PARETINA CON ELEMENTO SUPERIORE IN METACRILATO L.60 x H.111 module with upper methacrylate element w 60 x h 111	METACRILATO BIANCO white methacrylate	43	€ 143,00
152 802 *	MODULO PARETINA CON ELEMENTO SUPERIORE IN METACRILATO L.80 x H.111 module with upper methacrylate element w 80 x h 111	METACRILATO BIANCO white methacrylate	43	€ 176,00
152 804 *	MODULO PARETINA CON ELEMENTO SUPERIORE IN METACRILATO L.100 x H.111 module with upper methacrylate element w 100 x h 111	METACRILATO BIANCO white methacrylate	43	€ 198,00
152 805 *	MODULO PARETINA CON ELEMENTO SUPERIORE IN METACRILATO L.120 x H.111 module with upper methacrylate element w 120 x h 111	METACRILATO BIANCO white methacrylate	43	€ 250,00
152 806 *	MODULO PARETINA CON ELEMENTO SUPERIORE IN METACRILATO L.140 x H.111 module with upper methacrylate element w 140 x h 111	METACRILATO BIANCO white methacrylate	43	€ 262,00
152 807 *	MODULO PARETINA CON ELEMENTO SUPERIORE IN METACRILATO L.160 x H.111 module with upper methacrylate element w 160 x h 111	METACRILATO BIANCO white methacrylate	43	€ 302,00
152 808 *	MODULO PARETINA CON ELEMENTO SUPERIORE IN METACRILATO L.180 x H.111 module with upper methacrylate element w 180 x h 111	METACRILATO BIANCO white methacrylate	43	€ 332,00
152 890 *	MONTANTE PER PARETINA H.111 upright for partition panel h.111		47	€ 32,00
152 891 *	MONTANTE PER PARETINA H.150 upright for partition panel h.150		47	€ 43,00
152 893 *	GAMBA CORNICE TERMINALE DX O SX PROF. CM 60 right or left terminal frame leg deep 60 cms		47	€ 61,00
152 894 *	GAMBA CORNICE CENTRALE PROF. CM 60 central frame leg deep 60 cms		47	€ 72,00
152 895 *	GAMBA CORNICE TERMINALE DX O SX PROF. CM 80 right or left terminal frame leg deep 80 cms		47	€ 69,00
152 896 *	GAMBA CORNICE CENTRALE PROF. CM 80 central frame leg deep 80 cms		47	€ 78,00
152 898 *	STAFFA PER ATTACCO GAMBA A CORNICE-TRAVE-PARETINA strap for connection frame leg-beam-partition panel		47	€ 10,00
152 899 *	KIT 2 STAFFE PER GAMBE A CORNICE kit 2 stirrups for frame legs		47	€ 13,00
152 903 *	KIT TRAVI L.120 PER GAMBE A CORNICE kit beams w 120 for frame legs		47	€ 37,00
152 904 *	KIT TRAVI L.140 PER GAMBE A CORNICE kit beams w 140 for frame legs		47	€ 40,00
152 905 *	KIT TRAVI L.160 PER GAMBE A CORNICE kit beams w 160 for frame legs		47	€ 44,00
152 906 *	KIT TRAVI L.180 PER GAMBE A CORNICE kit beams w 180 for frame legs		47	€ 48,00
152 907 *	KIT 2 PIASTRINI REGGI-PIANO SU PARETINE kit 2 plates for fixing desktops with partition panels		48	€ 12,00
152 908 *	KIT 4 PIASTRINI REGGI-PIANO SU PARETINE kit 4 plates for fixing desktops with partition panels		48	€ 18,00
152 909 *	KIT 12 PIASTRINI REGGI-PIANO SU PARETINE kit 12 plates for fixing desktops with partition panels		48	€ 46,00
152 910 *	MODULO PARETINA CIECO L.60 x H.150 blind module w 60 x h 150	MELAMINICO melamine	44	€ 168,00
152 912 *	MODULO PARETINA CIECO L.80 x H.150 blind module w 80 x h 150	MELAMINICO melamine	44	€ 191,00
152 914 *	MODULO PARETINA CIECO L.100 x H.150 blind module w 100 x h 150	MELAMINICO melamine	44	€ 215,00
152 915 *	MODULO PARETINA CIECO L.120 x H.150 blind module w 120 x h 150	MELAMINICO melamine	44	€ 234,00
152 916 *	MODULO PARETINA CIECO L.140 x H.150 blind module w 140 x h 150	MELAMINICO melamine	44	€ 264,00
152 917 *	MODULO PARETINA CIECO L.160 x H.150 blind module w 160 x h 150	MELAMINICO melamine	44	€ 280,00
152 918 *	MODULO PARETINA CIECO L.180 x H.150 blind module w 180 x h 150	MELAMINICO melamine	44	€ 298,00
152 920 *	MODULO PARETINA CON ELEMENTO INTERMEDIO IN METACRILATO L.60 x H.150 module with intermediate methacrylate element w 60 x h 150	MELAMINICO melamine	44	€ 182,00
152 922 *	MODULO PARETINA CON ELEMENTO INTERMEDIO IN METACRILATO L.80 x H.150 module with intermediate methacrylate element w 80 x h 150	MELAMINICO melamine	44	€ 219,00
152 924 *	MODULO PARETINA CON ELEMENTO INTERMEDIO IN METACRILATO L.100 x H.150 module with intermediate methacrylate element w 100 x h 150	MELAMINICO melamine	44	€ 246,00
152 925 *	MODULO PARETINA CON ELEMENTO INTERMEDIO IN METACRILATO L.120 x H.150 module with intermediate methacrylate element w 120 x h 150	MELAMINICO melamine	44	€ 302,00
152 926 *	MODULO PARETINA CON ELEMENTO INTERMEDIO IN METACRILATO L.140 x H.150 module with intermediate methacrylate element w 140 x h 150	MELAMINICO melamine	44	€ 323,00
152 927 *	MODULO PARETINA CON ELEMENTO INTERMEDIO IN METACRILATO L.160 x H.150 module with intermediate methacrylate element w 160 x h 150	MELAMINICO melamine	44	€ 365,00
152 928 *	MODULO PARETINA CON ELEMENTO INTERMEDIO IN METACRILATO L.180 x H.150 module with intermediate methacrylate element w 180 x h 150	MELAMINICO melamine	44	€ 399,00
152 930 *	MODULO PARETINA CON ELEMENTO SUPERIORE IN METACRILATO L.60 x H.150 module with upper methacrylate element w 60 x h 150	MELAMINICO melamine	45	€ 182,00
152 932 *	MODULO PARETINA CON ELEMENTO SUPERIORE IN METACRILATO L.80 x H.150 module with upper methacrylate element w 80 x h 150	MELAMINICO melamine	45	€ 219,00
152 934 *	MODULO PARETINA CON ELEMENTO SUPERIORE IN METACRILATO L.100 x H.150 module with upper methacrylate element w 100 x h 150	MELAMINICO melamine	45	€ 246,00
152 935 *	MODULO PARETINA CON ELEMENTO SUPERIORE IN METACRILATO L.120 x H.150 module with upper methacrylate element w 120 x h 150	MELAMINICO melamine	45	€ 302,00
152 936 *	MODULO PARETINA CON ELEMENTO SUPERIORE IN METACRILATO L.140 x H.150 module with upper methacrylate element w 140 x h 150	MELAMINICO melamine	45	€ 323,00
152 937 *	MODULO PARETINA CON ELEMENTO SUPERIORE IN METACRILATO L.160 x H.150 module with upper methacrylate element w 160 x h 150	MELAMINICO melamine	45	€ 365,00
152 938 *	MODULO PARETINA CON ELEMENTO SUPERIORE IN METACRILATO L.180 x H.150 module with upper methacrylate element w 180 x h 150	MELAMINICO melamine	45	€ 399,00

\* = INDICARE IL CODICE FINITURA  
= complete with finish code

INDICE DEI CODICI / codes index  
Mod. 5th ELEMENT

5<sup>TH</sup> ELEMENT

CODICE code	DESCRIZIONE description			PAG. page	PREZZO price
152 940 *	MODULO PARETINA CIECO L.60 x H.111 blind module w 60 x h 111		TESSUTO fabric	43	€ 151,00
152 942 *	MODULO PARETINA CIECO L.80 x H.111 blind module w 80 x h 111		TESSUTO fabric	43	€ 176,00
152 944 *	MODULO PARETINA CIECO L.100 x H.111 blind module w 100 x h 111		TESSUTO fabric	43	€ 201,00
152 945 *	MODULO PARETINA CIECO L.120 x H.111 blind module w 120 x h 111		TESSUTO fabric	43	€ 222,00
152 946 *	MODULO PARETINA CIECO L.140 x H.111 blind module w 140 x h 111		TESSUTO fabric	43	€ 254,00
152 947 *	MODULO PARETINA CIECO L.160 x H.111 blind module w 160 x h 111		TESSUTO fabric	43	€ 275,00
152 948 *	MODULO PARETINA CIECO L.180 x H.111 blind module w 180 x h 111		TESSUTO fabric	43	€ 298,00
152 950 *	MODULO PARETINA CIECO L.60 x H.150 blind module w 60 x h 150		TESSUTO fabric	44	€ 229,00
152 952 *	MODULO PARETINA CIECO L.80 x H.150 blind module w 80 x h 150		TESSUTO fabric	44	€ 267,00
152 954 *	MODULO PARETINA CIECO L.100 x H.150 blind module w 100 x h 150		TESSUTO fabric	44	€ 309,00
152 955 *	MODULO PARETINA CIECO L.120 x H.150 blind module w 120 x h 150		TESSUTO fabric	44	€ 344,00
152 956 *	MODULO PARETINA CIECO L.140 x H.150 blind module w 140 x h 150		TESSUTO fabric	44	€ 396,00
152 957 *	MODULO PARETINA CIECO L.160 x H.150 blind module w 160 x h 150		TESSUTO fabric	44	€ 429,00
152 958 *	MODULO PARETINA CIECO L.180 x H.150 blind module w 180 x h 150		TESSUTO fabric	44	€ 465,00
152 960 *	MODULO PARETINA CON ELEMENTO INTERMEDIO IN METACRILATO L.60 x H.150 module with intermediate methacrylate element w 60 x h 150		TESSUTO fabric	44	€ 206,00
152 962 *	MODULO PARETINA CON ELEMENTO INTERMEDIO IN METACRILATO L.80 x H.150 module with intermediate methacrylate element w 80 x h 150		TESSUTO fabric	44	€ 253,00
152 964 *	MODULO PARETINA CON ELEMENTO INTERMEDIO IN METACRILATO L.100 x H.150 module with intermediate methacrylate element w 100 x h 150		TESSUTO fabric	44	€ 285,00
152 965 *	MODULO PARETINA CON ELEMENTO INTERMEDIO IN METACRILATO L.120 x H.150 module with intermediate methacrylate element w 120 x h 150		TESSUTO fabric	44	€ 348,00
152 966 *	MODULO PARETINA CON ELEMENTO INTERMEDIO IN METACRILATO L.140 x H.150 module with intermediate methacrylate element w 140 x h 150		TESSUTO fabric	44	€ 376,00
152 967 *	MODULO PARETINA CON ELEMENTO INTERMEDIO IN METACRILATO L.160 x H.150 module with intermediate methacrylate element w 160 x h 150		TESSUTO fabric	44	€ 428,00
152 968 *	MODULO PARETINA CON ELEMENTO INTERMEDIO IN METACRILATO L.180 x H.150 module with intermediate methacrylate element w 180 x h 150		TESSUTO fabric	44	€ 468,00
152 970 *	MODULO PARETINA CON ELEMENTO SUPERIORE IN METACRILATO L.60 x H.150 module with upper methacrylate element w 60 x h 150		TESSUTO fabric	45	€ 206,00
152 972 *	MODULO PARETINA CON ELEMENTO SUPERIORE IN METACRILATO L.80 x H.150 module with upper methacrylate element w 80 x h 150		TESSUTO fabric	45	€ 253,00
152 974 *	MODULO PARETINA CON ELEMENTO SUPERIORE IN METACRILATO L.100 x H.150 module with upper methacrylate element w 100 x h 150		TESSUTO fabric	45	€ 285,00
152 975 *	MODULO PARETINA CON ELEMENTO SUPERIORE IN METACRILATO L.120 x H.150 module with upper methacrylate element w 120 x h 150		TESSUTO fabric	45	€ 348,00
152 976 *	MODULO PARETINA CON ELEMENTO SUPERIORE IN METACRILATO L.140 x H.150 module with upper methacrylate element w 140 x h 150		TESSUTO fabric	45	€ 376,00
152 977 *	MODULO PARETINA CON ELEMENTO SUPERIORE IN METACRILATO L.160 x H.150 module with upper methacrylate element w 160 x h 150		TESSUTO fabric	45	€ 428,00
152 978 *	MODULO PARETINA CON ELEMENTO SUPERIORE IN METACRILATO L.180 x H.150 module with upper methacrylate element w 180 x h 150		TESSUTO fabric	45	€ 468,00
153 003 *	SCRIVANIA L.120 x p.60 CON GAMBE A PONTE desk w 120 x d 60 cms with bridge metal legs	18 mm		21	€ 304,00
153 004 *	SCRIVANIA L.140 x p.60 CON GAMBE A PONTE desk w 140 x d 60 cms with bridge metal legs	18 mm		21	€ 316,00
153 005 *	SCRIVANIA L.160 x p.60 CON GAMBE A PONTE desk w 160 x d 60 cms with bridge metal legs	18 mm		21	€ 329,00
153 006 *	SCRIVANIA L.180 x p.60 CON GAMBE A PONTE desk w 180 x d 60 cms with bridge metal legs	18 mm		21	€ 342,00
153 010 *	ALLUNGO L.120 x p.60 CON GAMBA A PONTE extension w 120 x d 60 cms with bridge metal leg	18 mm	GAMBE VERNICIATE painted legs	11-21	€ 259,00
153 010 *	ALLUNGO L.120 x p.60 CON GAMBA A PONTE extension w 120 x d 60 cms with bridge metal leg	18 mm	GAMBE CROMATE chromed legs	11-21	€ 394,00
153 013 *	ALLUNGO L.80 x p.60 CON GAMBA A PONTE extension w 80 x d 60 cms with bridge metal leg	18 mm	GAMBE VERNICIATE painted legs	11-21	€ 236,00
153 013 *	ALLUNGO L.80 x p.60 CON GAMBA A PONTE extension w 80 x d 60 cms with bridge metal leg	18 mm	GAMBE CROMATE chromed legs	11-21	€ 371,00
153 014 *	ALLUNGO L.100 x p.60 CON GAMBA A PONTE extension w 100 x d 60 cms with bridge metal leg	18 mm	GAMBE VERNICIATE painted legs	11-21	€ 248,00
153 014 *	ALLUNGO L.100 x p.60 CON GAMBA A PONTE extension w 100 x d 60 cms with bridge metal leg	18 mm	GAMBE CROMATE chromed legs	11-21	€ 383,00
153 015 *	ALLUNGO L.120 x p.60 PER CASSETTIERA-BASE extension w 120 x d 60 cms for base-pedestal	18 mm		11-21	€ 136,00
153 018 *	ALLUNGO L.80 x p.60 PER CASSETTIERA-BASE extension w 80 x d 60 cms for base-pedestal	18 mm		11-21	€ 124,00
153 019 *	ALLUNGO L.100 x p.60 PER CASSETTIERA-BASE extension w 100 x d 60 cms for base-pedestal	18 mm		11-21	€ 133,00
153 020 *	SCRIVANIA L.120 x p.80 CON GAMBE A PONTE desk w 120 x d 80 cms with bridge metal legs	18 mm		21	€ 335,00
153 021 *	SCRIVANIA L.140 x p.80 CON GAMBE A PONTE desk w 140 x d 80 cms with bridge metal legs	18 mm		21	€ 348,00
153 022 *	SCRIVANIA L.160 x p.80 CON GAMBE A PONTE desk w 160 x d 80 cms with bridge metal legs	18 mm		21	€ 361,00
153 023 *	SCRIVANIA L.180 x p.80 CON GAMBE A PONTE desk w 180 x d 80 cms with bridge metal legs	18 mm		21	€ 378,00
153 025 *	2 SCRIVANIE IN LINEA L.240 x p.80 CON GAMBE A PONTE 2 linear desks w 240 x d 80 cms with bridge metal legs	18 mm	CON GAMBA CENTRALE APERTA with open central leg	23	€ 535,00
153 026 *	2 SCRIVANIE IN LINEA L.280 x p.80 CON GAMBE A PONTE 2 linear desks w 280 x d 80 cms with bridge metal legs	18 mm	CON GAMBA CENTRALE APERTA with open central leg	23	€ 561,00
153 027 *	2 SCRIVANIE IN LINEA L.320 x p.80 CON GAMBE A PONTE 2 linear desks w 320 x d 80 cms with bridge metal legs	18 mm	CON GAMBA CENTRALE APERTA with open central leg	23	€ 587,00
153 028 *	2 SCRIVANIE IN LINEA L.240 x p.80 CON GAMBE A PONTE 2 linear desks w 240 x d 80 cms with bridge metal legs	18 mm	CON GAMBA CENTRALE APERTA with open central leg	23	€ 621,00
153 035 *	3 SCRIVANIE IN LINEA L.360 x p.80 CON GAMBE A PONTE 3 linear desks w 360 x d 80 cms with bridge metal legs	18 mm	CON GAMBE CENTRALI APERTE with open central legs	23	€ 735,00

\* = INDICARE IL CODICE FINITURA  
= complete with finish code

INDICE DEI CODICI / codes index  
Mod. 9th ELEMENT

CODICE code	DESCRIZIONE description		PAG. page	PREZZO price
153 036 *	3 SCRIVANIE IN LINEA L.420 x p.80 CON GAMBE A PONTE 3 linear desks w 420 x d 80 cms with bridge metal legs	18 mm	CON GAMBE CENTRALI APERTE with open central legs	23 € 774,00
153 037 *	3 SCRIVANIE IN LINEA L.480 x p.80 CON GAMBE A PONTE 3 linear desks w 480 x d 80 cms with bridge metal legs	18 mm	CON GAMBE CENTRALI APERTE with open central legs	23 € 813,00
153 038 *	3 SCRIVANIE IN LINEA L.540 x p.80 CON GAMBE A PONTE 3 linear desks w 540 x d 80 cms with bridge metal legs	18 mm	CON GAMBE CENTRALI APERTE with open central legs	23 € 864,00
153 055 *	1 BENCH L.120 x p.60+60 CON GAMBE A PONTE 1 bench w 120 x d 60+60 cms with bridge metal legs	18 mm		24 € 480,00
153 056 *	1 BENCH L.140 x p.60+60 CON GAMBE A PONTE 1 bench w 140 x d 60+60 cms with bridge metal legs	18 mm		24 € 504,00
153 057 *	1 BENCH L.160 x p.60+60 CON GAMBE A PONTE 1 bench w 160 x d 60+60 cms with bridge metal legs	18 mm		24 € 530,00
153 058 *	1 BENCH L.180 x p.60+60 CON GAMBE A PONTE 1 bench w 180 x d 60+60 cms with bridge metal legs	18 mm		24 € 556,00
153 060 *	BENCH L.240 x p.60+60 CON GAMBE A PONTE bench w 240 x d 60+60 cms with bridge metal legs	18 mm	CON GAMBA CENTRALE APERTA with open central leg	24 € 810,00
153 061 *	BENCH L.280 x p.60+60 CON GAMBE A PONTE bench w 280 x d 60+60 cms with bridge metal legs	18 mm	CON GAMBA CENTRALE APERTA with open central leg	24 € 858,00
153 062 *	BENCH L.320 x p.60+60 CON GAMBE A PONTE bench w 320 x d 60+60 cms with bridge metal legs	18 mm	CON GAMBA CENTRALE APERTA with open central leg	24 € 910,00
153 063 *	BENCH L.360 x p.60+60 CON GAMBE A PONTE bench w 360 x d 60+60 cms with bridge metal legs	18 mm	CON GAMBA CENTRALE APERTA with open central leg	24 € 962,00
153 070 *	BENCH L.360 x p.60+60 CON GAMBE A PONTE bench w 360 x d 60+60 cms with bridge metal legs	18 mm	CON GAMBE CENTRALI APERTE with open central legs	24 € 1.140,00
153 071 *	BENCH L.420 x p.60+60 CON GAMBE A PONTE bench w 420 x d 60+60 cms with bridge metal legs	18 mm	CON GAMBE CENTRALI APERTE with open central legs	24 € 1.212,00
153 072 *	BENCH L.480 x p.60+60 CON GAMBE A PONTE bench w 480 x d 60+60 cms with bridge metal legs	18 mm	CON GAMBE CENTRALI APERTE with open central legs	24 € 1.290,00
153 073 *	BENCH L.540 x p.60+60 CON GAMBE A PONTE bench w 540 x d 60+60 cms with bridge metal legs	18 mm	CON GAMBE CENTRALI APERTE with open central legs	24 € 1.368,00
153 090 *	BENCH L.120 x p.80+80 CON GAMBA A PONTE bench w 120 x d 80+80 cms with bridge metal legs	18 mm		24 € 550,00
153 091 *	BENCH L.140 x p.80+80 CON GAMBA A PONTE bench w 140 x d 80+80 cms with bridge metal legs	18 mm		24 € 576,00
153 092 *	BENCH L.160 x p.80+80 CON GAMBA A PONTE bench w 160 x d 80+80 cms with bridge metal legs	18 mm		24 € 602,00
153 093 *	BENCH L.180 x p.80+80 CON GAMBA A PONTE bench w 180 x d 80+80 cms with bridge metal legs	18 mm		24 € 636,00
153 095 *	ALLUNGO L80 x p.60 CON GAMBA A "LOOP" extension w 80 x d 60 cms with "loop" metal leg	18 mm	GAMBE VERNICIATE painted legs	11 € 286,00
153 095 *	ALLUNGO L80 x p.60 CON GAMBA A "LOOP" extension w 80 x d 60 cms with "loop" metal leg	18 mm	GAMBE CROMATE chromed legs	11 € 461,00
153 096 *	ALLUNGO L.100 x p.60 CON GAMBA A "LOOP" extension w 100 x d 60 cms with "loop" metal leg	18 mm	GAMBE VERNICIATE painted legs	11 € 298,00
153 096 *	ALLUNGO L.100 x p.60 CON GAMBA A "LOOP" extension w 100 x d 60 cms with "loop" metal leg	18 mm	GAMBE CROMATE chromed legs	11 € 473,00
153 097 *	ALLUNGO L.120 x p.60 CON GAMBA A "LOOP" extension w 120 x d 60 cms with "loop" metal leg	18 mm	GAMBE VERNICIATE painted legs	11 € 309,00
153 097 *	ALLUNGO L.120 x p.60 CON GAMBA A "LOOP" extension w 120 x d 60 cms with "loop" metal leg	18 mm	GAMBE CROMATE chromed legs	11 € 484,00
153 136 *	TAVOLO RIUNIONE L.240 x p.125.2 meeting table w 240 x d 125.2 cms	18 mm	CON GAMBA CENTRALE APERTA with open central leg	68 € 850,00
153 137 *	TAVOLO RIUNIONE L.360 x p.125.2 meeting table w 360 x d 125.2 cms	18 mm	CON GAMBE CENTRALI APERTE with open central legs	68 € 1.200,00
153 140 *	BENCH L.240 x p.80+80 CON GAMBE A PONTE bench w 240 x d 80+80 cms with bridge metal legs	18 mm	CON GAMBA CENTRALE APERTA with open central leg	24 € 916,00
153 141 *	BENCH L.280 x p.80+80 CON GAMBE A PONTE bench w 280 x d 80+80 cms with bridge metal legs	18 mm	CON GAMBA CENTRALE APERTA with open central leg	24 € 968,00
153 142 *	BENCH L.320 x p.80+80 CON GAMBE A PONTE bench w 320 x d 80+80 cms with bridge metal legs	18 mm	CON GAMBA CENTRALE APERTA with open central leg	24 € 1.020,00
153 143 *	BENCH L.360 x p.80+80 CON GAMBE A PONTE bench w 360 x d 80+80 cms with bridge metal legs	18 mm	CON GAMBA CENTRALE APERTA with open central leg	24 € 1.088,00
153 150 *	BENCH L.360 x p.80+80 CON GAMBE A PONTE bench w 360 x d 80+80 cms with bridge metal legs	18 mm	CON GAMBE CENTRALI APERTE with open central legs	24 € 1.282,00
153 151 *	BENCH L.420 x p.80+80 CON GAMBE A PONTE bench w 420 x d 80+80 cms with bridge metal legs	18 mm	CON GAMBE CENTRALI APERTE with open central legs	24 € 1.360,00
153 152 *	BENCH L.480 x p.80+80 CON GAMBE A PONTE bench w 480 x d 80+80 cms with bridge metal legs	18 mm	CON GAMBE CENTRALI APERTE with open central legs	24 € 1.438,00
153 153 *	BENCH L.540 x p.80+80 CON GAMBE A PONTE bench w 540 x d 80+80 cms with bridge metal legs	18 mm	CON GAMBE CENTRALI APERTE with open central legs	24 € 1.540,00
153 169 *	SCRIVANIA TERMINALE PER BENCH PROF. CM 80+80 terminal desk for bench deep 80+80 cms	18 mm		24 € 372,00
153 180 *	TAVOLO RIUNIONE L.120 x p.125.2 meeting table w 120 x d 125.2 cms	18 mm	GAMBE VERNICIATE painted legs	67 € 500,00
153 180 *	TAVOLO RIUNIONE L.120 x p.125.2 meeting table w 120 x d 125.2 cms	18 mm	GAMBE CROMATE chromed legs	67 € 954,00
153 181 *	TAVOLO RIUNIONE L.320 x p.125.2 meeting table w 320 x d 125.2 cms	18 mm	CON GAMBA CENTRALE APERTA with open central leg	68 € 950,00
153 182 *	TAVOLO RIUNIONE L.480 x p.125.2 meeting table w 480 x d 125.2 cms	18 mm	CON GAMBE CENTRALI APERTE with open central legs	68 € 1.350,00
153 185 *	TAVOLO RIUNIONE L.160 x p.165.2 meeting table w 160 x d 165.2 cms	18 mm	GAMBE VERNICIATE painted legs	69 € 625,00
153 186 *	TAVOLO RIUNIONE L.320 x p.165.2 meeting table w 320 x d 165.2 cms	18 mm	CON GAMBA CENTRALE APERTA with open central leg	69 € 1.066,00
153 187 *	TAVOLO RIUNIONE L.480 x p.165.2 meeting table w 480 x d 165.2 cms	18 mm	CON GAMBE CENTRALI APERTE with open central legs	69 € 1.507,00
153 190 *	SCRIVANIA L.120 x p.60 CON GAMBA A PONTE PER PORTA-CPU desk w 120 x d 60 cms with bridge metal leg for CPU-holder	18 mm		26 € 229,00
153 191 *	SCRIVANIA L.140 x p.60 CON GAMBA A PONTE PER PORTA-CPU desk w 140 x d 60 cms with bridge metal leg for CPU-holder	18 mm		26 € 242,00
153 192 *	SCRIVANIA L.160 x p.60 CON GAMBA A PONTE PER PORTA-CPU desk w 160 x d 60 cms with bridge metal leg for CPU-holder	18 mm		26 € 254,00
153 193 *	SCRIVANIA L.180 x p.60 CON GAMBA A PONTE PER PORTA-CPU desk w 180 x d 60 cms with bridge metal leg for CPU-holder	18 mm		26 € 266,00
153 194 *	TAVOLO RIUNIONE L.160 x p.125.2 meeting table w 160 x d 125.2 cms	18 mm	GAMBE VERNICIATE painted legs	67 € 550,00
153 194 *	TAVOLO RIUNIONE L.160 x p.125.2 meeting table w 160 x d 125.2 cms	18 mm	GAMBE CROMATE chromed legs	67 € 1.004,00
153 195 *	SCRIVANIA L.120 x p.80 CON GAMBA A PONTE PER PORTA-CPU desk w 120 x d 80 cms with bridge metal leg for CPU-holder	18 mm		26 € 250,00
153 196 *	SCRIVANIA L.140 x p.80 CON GAMBA A PONTE PER PORTA-CPU desk w 140 x d 80 cms with bridge metal leg for CPU-holder	18 mm		26 € 264,00

\* = INDICARE IL CODICE FINITURA  
= complete with finish code

INDICE DEI CODICI / codes index  
Mod. 5th ELEMENT

CODICE code	DESCRIZIONE description	PAG. page	PREZZO price
153 197 *	SCRIVANIA L.160 x p.80 CON GAMBIA A PONTE PER PORTA-CPU desk w 160 x d 80 cms with bridge metal leg for CPU-holder	18 mm	26 € 276,00
153 198 *	SCRIVANIA L.180 x p.80 CON GAMBIA A PONTE PER PORTA-CPU desk w 180 x d 80 cms with bridge metal leg for CPU-holder	18 mm	26 € 292,00
153 201 *	COPERTURA CENTRALE PER BENCH L.60 CON PARETINA central cover profile for bench w 60 cms with partition panels		28 € 35,00
153 202 *	COPERTURA CENTRALE PER BENCH L.70 CON PARETINA central cover profile for bench w 70 cms with partition panels		28 € 37,00
153 203 *	COPERTURA CENTRALE PER BENCH L.80 CON PARETINA central cover profile for bench w 80 cms with partition panels		28 € 39,00
153 204 *	COPERTURA CENTRALE PER BENCH L.90 CON PARETINA central cover profile for bench w 90 cms with partition panels		28 € 42,00
153 206 *	STAFFA PER COPERTURA CENTRALE DI BENCH strap for central cover profile for bench		28 € 15,00
153 212 *	BENCH L.140 x p.60+80 CON GAMBIA A PONTE PER PORTA-CPU bench w 140 x d 60+80 cms with bridge metal leg for CPU-holder	18 mm	26 € 420,00
153 213 *	BENCH L.160 x p.60+80 CON GAMBIA A PONTE PER PORTA-CPU bench w 160 x d 60+80 cms with bridge metal leg for CPU-holder	18 mm	26 € 444,00
153 214 *	BENCH L.180 x p.60+80 CON GAMBIA A PONTE PER PORTA-CPU bench w 180 x d 60+80 cms with bridge metal leg for CPU-holder	18 mm	26 € 468,00
153 216 *	BENCH L.140 x p.80+80 CON GAMBIA A PONTE PER PORTA-CPU bench w 140 x d 80+80 cms with bridge metal leg for CPU-holder	18 mm	26 € 468,00
153 217 *	BENCH L.160 x p.80+80 CON GAMBIA A PONTE PER PORTA-CPU bench w 160 x d 80+80 cms with bridge metal leg for CPU-holder	18 mm	26 € 492,00
153 218 *	BENCH L.180 x p.80+80 CON GAMBIA A PONTE PER PORTA-CPU bench w 180 x d 80+80 cms with bridge metal leg for CPU-holder	18 mm	26 € 524,00
153 220 *	COPERTURA CENTRALE PER BENCH L.120 central cover profile for bench w 120 cms		28 € 54,00
153 221 *	COPERTURA CENTRALE PER BENCH L.140 central cover profile for bench w 140 cms		28 € 57,00
153 222 *	COPERTURA CENTRALE PER BENCH L.160 central cover profile for bench w 160 cms		28 € 59,00
153 223 *	COPERTURA CENTRALE PER BENCH L.180 central cover profile for bench w 180 cms		28 € 61,00
153 234 *	COPERTURA CENTRALE PER BENCH L.100 CON PARETINA central cover profile for bench w 100 cms with partition panels		28 € 45,00
153 239 *	COPERTURA CENTRALE PER BENCH L.120 CON PARETINA central cover profile for bench w 120 cms with partition panels		28 € 48,00
153 240 *	VASCHETTA CENTRALE PASSACAVI L.90 PER BENCH central cable tray w 90 cms for bench		37 € 42,00
153 241 *	VASCHETTA CENTRALE PASSACAVI L.90 PER TAVOLI RIUNIONE central cable tray w 90 cms for meeting tables		70 € 54,00
153 242 *	VASCHETTA CENTRALE PASSACAVI L.121 PER BENCH central cable tray w 121 cms for bench		37 € 51,00
153 243 *	VASCHETTA CENTRALE PASSACAVI L.121 PER TAVOLI RIUNIONE central cable tray w 121 cms for meeting tables		70 € 61,00
153 245 *	PANNELLO LATERALE L.50 side panel w 50	MELAMINICO melamine	29 € 48,00
153 246 *	PANNELLO LATERALE L.70 side panel w 70	MELAMINICO melamine	29 € 54,00
153 247 *	PANNELLO LATERALE L.80 side panel w 80	MELAMINICO melamine	29 € 59,00
153 248 *	PANNELLO LATERALE L.50 side panel w 50	TESSUTO fabric	29 € 128,00
153 249 *	PANNELLO LATERALE L.70 side panel w 70	TESSUTO fabric	29 € 141,00
153 250 *	PANNELLO LATERALE L.80 side panel w 80	TESSUTO fabric	29 € 154,00
153 251 *	PANNELLO LATERALE L.50 side panel w 50	METACRILATO BIANCO white methacrylate	29 € 105,00
153 252 *	PANNELLO LATERALE L.70 side panel w 70	METACRILATO BIANCO white methacrylate	29 € 118,00
153 253 *	PANNELLO LATERALE L.80 side panel w 80	METACRILATO BIANCO white methacrylate	29 € 128,00
153 264 *	PORTA-CPU SOSPESO suspended CPU-holder		29 € 124,00
153 267 *	TAVOLO TEAM L.160 X P.80 X H.105 team table w 160 x d 80 x h 105	18 mm	GAMBE VERNICIATE painted legs 71 € 654,00
153 268 *	TAVOLO TEAM L.180 X P.80 X H.105 team table w 180 x d 80 x h 105	18 mm	GAMBE VERNICIATE painted legs 71 € 685,00
153 304 *	PANNELLO FRONTALE CON BARRA ATTREZZABILE + COPERTURA CENTRALE PER BENCH L.120 x H.46,7 front panel with toolbar + central cover profile for bench w 120 x h 46,7 cms	TESSUTO fabric	32 € 263,00
153 305 *	PANNELLO FRONTALE CON BARRA ATTREZZABILE + COPERTURA CENTRALE PER BENCH L.140 x H.46,7 front panel with toolbar + central cover profile for bench w 140 x h 46,7 cms	TESSUTO fabric	32 € 281,00
153 306 *	PANNELLO FRONTALE CON BARRA ATTREZZABILE + COPERTURA CENTRALE PER BENCH L.160 x H.46,7 front panel with toolbar + central cover profile for bench w 160 x h 46,7 cms	TESSUTO fabric	32 € 314,00
153 307 *	PANNELLO FRONTALE CON BARRA ATTREZZABILE + COPERTURA CENTRALE PER BENCH L.180 x H.46,7 front panel with toolbar + central cover profile for bench w 180 x h 46,7 cms	TESSUTO fabric	32 € 358,00
153 360 *	PANNELLO FRONTALE CON BARRA ATTREZZABILE + COPERTURA CENTRALE PER BENCH L.120 x H.38,2 front panel with toolbar + central cover profile for bench w 120 x h 38,2 cms	TESSUTO fabric	32 € 248,00
153 361 *	PANNELLO FRONTALE CON BARRA ATTREZZABILE + COPERTURA CENTRALE PER BENCH L.140 x H.38,2 front panel with toolbar + central cover profile for bench w 140 x h 38,2 cms	TESSUTO fabric	32 € 270,00
153 362 *	PANNELLO FRONTALE CON BARRA ATTREZZABILE + COPERTURA CENTRALE PER BENCH L.160 x H.38,2 front panel with toolbar + central cover profile for bench w 160 x h 38,2 cms	TESSUTO fabric	32 € 312,00
153 363 *	PANNELLO FRONTALE CON BARRA ATTREZZABILE + COPERTURA CENTRALE PER BENCH L.180 x H.38,2 front panel with toolbar + central cover profile for bench w 180 x h 38,2 cms	TESSUTO fabric	32 € 345,00
153 400 *	BARRA ATTREZZABILE FRONTALE E COPERTURA CENTRALE PER BENCH L.120 front toolbar and central cover for bench w 120 cms		30 € 130,00
153 401 *	BARRA ATTREZZABILE FRONTALE E COPERTURA CENTRALE PER BENCH L.140 front toolbar and central cover for bench w 140 cms		30 € 147,00
153 402 *	BARRA ATTREZZABILE FRONTALE E COPERTURA CENTRALE PER BENCH L.160 front toolbar and central cover for bench w 160 cms		30 € 160,00
153 403 *	BARRA ATTREZZABILE FRONTALE E COPERTURA CENTRALE PER BENCH L.180 front toolbar and central cover for bench w 180 cms		30 € 175,00
153 407 *	SCHERMO FRONTALE IN METACRILATO BIANCO L.60 x H.38,2 white methacrylate front screen w 60 x h 38,2		30 € 40,00
153 408 *	SCHERMO FRONTALE IN METACRILATO BIANCO L.80 x H.38,2 white methacrylate front screen w 80 x h 38,2		30 € 53,00
153 409 *	SCHERMO FRONTALE IN METACRILATO BIANCO L.100 x H.38,2 white methacrylate front screen w 100 x h 38,2		30 € 72,00
153 410 *	SCHERMO FRONTALE IN METACRILATO BIANCO L.120 x H.38,2 white methacrylate front screen w 120 x h 38,2		30 € 85,00

5th ELEMENT

\* = INDICARE IL CODICE FINITURA  
\* complete with finish code

INDICE DEI CODICI / codes index  
Mod. 9th ELEMENT

CODICE code	DESCRIZIONE description			PAG. page	PREZZO price
153 411 *	SCHERMO FRONTALE IN METACRILATO BIANCO L.140 x H.38,2 white methacrylate front screen w 140 x h 38,2			30	€ 99,00
153 412 *	SCHERMO FRONTALE IN METACRILATO BIANCO L.160 x H.38,2 white methacrylate front screen w 160 x h 38,2			30	€ 114,00
153 413 *	SCHERMO FRONTALE IN METACRILATO BIANCO L.180 x H.38,2 white methacrylate front screen w 180 x h 38,2			30	€ 137,00
153 430 *	BARRA ATTREZZABILE LATERALE L.125,2 lateral toolbar w 125,2 cms			31	€ 91,00
153 431 *	BARRA ATTREZZABILE LATERALE L.165,2 lateral toolbar w 165,2 cms			31	€ 119,00
153 433 *	BARRA ATTREZZABILE LATERALE L.140 lateral toolbar w 140 cms			31	€ 102,00
153 434 *	BARRA ATTREZZABILE LATERALE L.200 lateral toolbar w 200 cms			31	€ 133,00
153 435 *	BARRA ATTREZZABILE LATERALE L.280 lateral toolbar w 280 cms			31	€ 191,00
153 436 *	BARRA ATTREZZABILE LATERALE L.340 lateral toolbar w 340 cms			31	€ 223,00
153 450 *	MENSOLA CENTRALE central shelf			30	€ 46,00
153 451 *	PORTA-DOX CENTRALE central dox-holder			30	€ 102,00
153 461 *	SCHIENA PER SCRIVANIA DIREZIONALE L.160 (CON 2 GAMBE METALLICHE) modesty panel for executive desk w 160 cms (with 2 metal legs)	18 mm		10	€ 40,00
153 463 *	SCHIENA PER SCRIVANIA DIREZIONALE L.180 (CON 2 GAMBE METALLICHE) modesty panel for executive desk w 180 cms (with 2 metal legs)	18 mm		10	€ 43,00
153 464 *	SCHIENA PER SCRIVANIA DIREZIONALE L.180 (CON 1 GAMBA METALLICA+1 MOBILE BASE) modesty panel for executive desk w 180 cms (with 1 metal leg+1 undertop cabinet)	18 mm		10	€ 40,00
153 466 *	SCHIENA PER SCRIVANIA DIREZIONALE L.200 (CON 2 GAMBE METALLICHE) modesty panel for executive desk w 200 cms (with 2 metal legs)	18 mm		10	€ 54,00
153 467 *	SCHIENA PER SCRIVANIA DIREZIONALE L.220 (CON 2 GAMBE METALLICHE) modesty panel for executive desk w 220 cms (with 2 metal legs)	18 mm		10	€ 59,00
153 468 *	SCHIENA PER SCRIVANIA DIREZIONALE L.200 (CON 1 GAMBA METALLICA+1 MOBILE BASE) modesty panel for executive desk w 200 cms (with 1 metal leg+1 undertop cabinet)	18 mm		10	€ 51,00
153 500 *	PANNELLO FRONTALE+COPERTURA CENTRALE PER BENCH L.120 front panel + central cover profile for bench w 120 cms		MELAMINICO melamine	28	€ 105,00
153 501 *	PANNELLO FRONTALE+COPERTURA CENTRALE PER BENCH L.140 front panel + central cover profile for bench w 140 cms		MELAMINICO melamine	28	€ 116,00
153 502 *	PANNELLO FRONTALE+COPERTURA CENTRALE PER BENCH L.160 front panel + central cover profile for bench w 160 cms		MELAMINICO melamine	28	€ 127,00
153 503 *	PANNELLO FRONTALE+COPERTURA CENTRALE PER BENCH L.180 front panel + central cover profile for bench w 180 cms		MELAMINICO melamine	28	€ 140,00
153 505 *	PANNELLO FRONTALE+COPERTURA CENTRALE PER BENCH L.120 front panel + central cover profile for bench w 120 cms		TESSUTO fabric	28	€ 210,00
153 506 *	PANNELLO FRONTALE+COPERTURA CENTRALE PER BENCH L.140 front panel + central cover profile for bench w 140 cms		TESSUTO fabric	28	€ 222,00
153 507 *	PANNELLO FRONTALE+COPERTURA CENTRALE PER BENCH L.160 front panel + central cover profile for bench w 160 cms		TESSUTO fabric	28	€ 248,00
153 508 *	PANNELLO FRONTALE+COPERTURA CENTRALE PER BENCH L.180 front panel + central cover profile for bench w 180 cms		TESSUTO fabric	28	€ 269,00
153 510 *	PANNELLO FRONTALE+COPERTURA CENTRALE PER BENCH L.120 front panel + central cover profile for bench w 120 cms		METACRILATO BIANCO white methacrylate	28	€ 155,00
153 511 *	PANNELLO FRONTALE+COPERTURA CENTRALE PER BENCH L.140 front panel + central cover profile for bench w 140 cms		METACRILATO BIANCO white methacrylate	28	€ 168,00
153 512 *	PANNELLO FRONTALE+COPERTURA CENTRALE PER BENCH L.160 front panel + central cover profile for bench w 160 cms		METACRILATO BIANCO white methacrylate	28	€ 183,00
153 513 *	PANNELLO FRONTALE+COPERTURA CENTRALE PER BENCH L.180 front panel + central cover profile for bench w 180 cms		METACRILATO BIANCO white methacrylate	28	€ 222,00
153 536 *	PIANO TAVOLO RIUNIONE L.120 x p.125,2 meeting tabletop w 120 x d 125,2 cms	18 mm	SENZA TOP ACCESS without top access	70	€ 83,00
153 539 *	PIANO TAVOLO RIUNIONE L.160 x p.125,2 meeting tabletop w 160 x d 125,2 cms	18 mm	SENZA TOP ACCESS without top access	70	€ 107,00
153 543 *	PIANO TAVOLO RIUNIONE L.160 x p.165,2 meeting tabletop w 160 x d 165,2 cms	18 mm	SENZA TOP ACCESS without top access	70	€ 137,00
153 639 *	TOP PER MOBILE SOTTOPIANO L.80 x p.46,2 top for undertop cabinet w 80 x d 46,2 cms	18 mm	CON VENATURA TRASVERSALE with transversal wood veining	56	€ 28,00
153 659 *	STAFFA SUPPLEMENTARE DI RINFORZO PER ALLUNGHI additional undertop stirrup for extensions			46	€ 23,00
153 700 *	GAMBA A PONTE TERMINALE PROF. CM 60 terminal bridge leg deep 60 cms			35	€ 96,00
153 701 *	GAMBA A PONTE TERMINALE PROF. CM 80 terminal bridge leg deep 80 cms			35	€ 106,00
153 702 *	GAMBA A PONTE TERMINALE PROF. CM 125 terminal bridge leg deep 125 cms			35-69	€ 128,00
153 703 *	GAMBA A PONTE TERMINALE PROF. CM 165 terminal bridge leg deep 165 cms			35-69	€ 152,00
153 707 *	GAMBA A PONTE CENTRALE PROF. CM 80 central bridge leg deep 80 cms			35	€ 77,00
153 708 *	GAMBA A PONTE CENTRALE PROF. CM 125 central bridge leg deep 125 cms			35-69	€ 106,00
153 709 *	GAMBA A PONTE CENTRALE PROF. CM 165 central bridge leg deep 165 cms			35-69	€ 120,00
153 718 *	KIT 2 STAFFE PER ATTACCO TRAVI A PARETINA set of stirrups for connection with partition panels			39	€ 30,00
153 719 *	KIT 2 TRAVERSI PER VASCHETTA CENTRALE PASSACAVI BENCH set of 2 metal crossbars for central cable-tray bench			37	€ 24,00
153 720 *	COPPIA DI TRAVI L.100 PER GAMBE A PONTE set of 2 beams w 100 for bridge legs			36	€ 61,00
153 721 *	COPPIA DI TRAVI L.120 PER GAMBE A PONTE set of 2 beams w 120 for bridge legs			36-69	€ 68,00
153 722 *	COPPIA DI TRAVI L.140 PER GAMBE A PONTE set of 2 beams w 140 for bridge legs			36	€ 74,00
153 723 *	COPPIA DI TRAVI L.160 PER GAMBE A PONTE set of 2 beams w 160 for bridge legs			36-69	€ 81,00
153 724 *	COPPIA DI TRAVI L.180 PER GAMBE A PONTE set of 2 beams w 180 for bridge legs			36	€ 89,00
153 725 *	KIT 2 STAFFE PER ATTACCO TRAVI SU PORTA-CPU kit 2 stirrups for fixing beams with CPU-holder			39	€ 28,00
153 726 *	KIT 2 STAFFE PER VASCHETTA CENTRALE PASSACAVI BENCH set of 2 stirrups for central cable-tray bench			37	€ 15,00
153 728 *	KI 2 STAFFE PER ATTACCO TRAVI SU CASSETTIERE LATERALI O MOBILI LATERALI kit 2 stirrups for fixing beams with lateral pedestals or lateral cabinets			39	€ 32,00



\* = INDICARE IL CODICE FINITURA  
= complete with finish code

INDICE DEI CODICI / codes index  
Mod. 9th ELEMENT

CODICE code	DESCRIZIONE description	PAG. page	PREZZO price
153 734 *	COPIA DI TRAVI PER SCRIVANIA TERMINALE CON GAMBE A PONTE L.165,2 set of 2 beams for terminal desk with bridge legs w 165,2 cms	36	€ 88,00
153 737 *	KIT WIRE-MANAGER PROF. CM 80 wire manager kit deep 80 cms	35	€ 98,00
153 738 *	KIT WIRE-MANAGER PROF. CM 125,2 wire manager kit deep 125,2 cms	35-69	€ 117,00
153 739 *	KIT WIRE-MANAGER PROF. CM 165,2 wire manager kit deep 165,2 cms	35-69	€ 119,00
153 740 *	GAMBA TERMINALE CON ALTEZZA REGOLABILE PER SCRIVANIA O BENCH SINGOLI PROF. CM 60 terminal leg with adjustable height for single desk or single bench deep 60 cms	35	€ 166,00
153 741 *	GAMBA TERMINALE CON ALTEZZA REGOLABILE PER SCRIVANIA O BENCH SINGOLI PROF. CM 80 terminal leg with adjustable height for single desk or single bench deep 80 cms	35	€ 177,00
153 743 *	GAMBA TERMINALE CON ALTEZZA REGOLABILE PER SCRIVANIA O BENCH SINGOLI PROF. CM 125 terminal leg with adjustable height for single desk or single bench deep 125 cms	35	€ 213,00
153 744 *	GAMBA TERMINALE CON ALTEZZA REGOLABILE PER SCRIVANIA O BENCH SINGOLI PROF. CM 165 terminal leg with adjustable height for single desk or single bench deep 165 cms	35	€ 239,00
153 748 *	KIT 2 STAFFE PER 1 PIANO SCORREVOLE PROF. CM 60 kit 2 stirrups for 1 sliding desktop deep 60 cms	39	€ 55,00
153 749 *	KIT 2 STAFFE PER 1 PIANO SCORREVOLE PROF. CM 80-90 kit 2 stirrups for 1 sliding desktop deep 80-90 cms	39	€ 68,00
153 750 *	MENSOLA PORTA-DOCUMENTI file-holder shelf	33	€ 46,00
153 751 *	BRACCIO GIREVOLE PORTA-VIDEO rotating video stand arm	33	€ 188,00
153 753 *	LAMPADA A LED led lamp	33-63	€ 387,00
153 755 *	SUPPORTO PER LAMPADE O PER BRACCIO GIREVOLE SU BARRA ATTREZZABILE support for lamps or rotating video stand arm on toolbar	33	€ 22,00
153 756 *	SUPPORTO PER LAMPADE SU BARRA ATTREZZABILE support for lamps on toolbar	33	€ 32,00
153 760 *	1 BENCH PIANI SCORREVOLI L.120 x p.60+60 CON GAMBE A PONTE 1 bench sliding worktops w 120 x d 60+60 cms with bridge metal legs	18 mm	25 € 590,00
153 761 *	1 BENCH PIANI SCORREVOLI L.140 x p.60+60 CON GAMBE A PONTE 1 bench sliding worktops w 140 x d 60+60 cms with bridge metal legs	18 mm	25 € 614,00
153 762 *	1 BENCH PIANI SCORREVOLI L.160 x p.60+60 CON GAMBE A PONTE 1 bench sliding worktops w 160 x d 60+60 cms with bridge metal legs	18 mm	25 € 640,00
153 763 *	1 BENCH PIANI SCORREVOLI L.180 x p.60+60 CON GAMBE A PONTE 1 bench sliding worktops w 180 x d 60+60 cms with bridge metal legs	18 mm	25 € 666,00
153 765 *	BENCH PIANI SCORREVOLI L.240 x p.60+60 CON GAMBE A PONTE bench sliding worktops w 240 x d 60+60 cms with bridge metal legs	18 mm	25 € 1.030,00
153 766 *	BENCH PIANI SCORREVOLI L.280 x p.60+60 CON GAMBE A PONTE bench sliding worktops w 280 x d 60+60 cms with bridge metal legs	18 mm	25 € 1.078,00
153 767 *	BENCH PIANI SCORREVOLI L.320 x p.60+60 CON GAMBE A PONTE bench sliding worktops w 320 x d 60+60 cms with bridge metal legs	18 mm	25 € 1.130,00
153 768 *	BENCH PIANI SCORREVOLI L.360 x p.60+60 CON GAMBE A PONTE bench sliding worktops w 360 x d 60+60 cms with bridge metal legs	18 mm	25 € 1.182,00
153 774 *	BENCH PIANI SCORREVOLI L.120 x p.80+80 CON GAMBE A PONTE bench sliding worktops w 120 x d 80+80 cms with bridge metal legs	18 mm	25 € 686,00
153 775 *	BENCH PIANI SCORREVOLI L.140 x p.80+80 CON GAMBE A PONTE bench sliding worktops w 140 x d 80+80 cms with bridge metal legs	18 mm	25 € 712,00
153 776 *	BENCH PIANI SCORREVOLI L.160 x p.80+80 CON GAMBE A PONTE bench sliding worktops w 160 x d 80+80 cms with bridge metal legs	18 mm	25 € 738,00
153 777 *	BENCH PIANI SCORREVOLI L.180 x p.80+80 CON GAMBE A PONTE bench sliding worktops w 180 x d 80+80 cms with bridge metal legs	18 mm	25 € 772,00
153 778 *	BENCH PIANI SCORREVOLI L.240 x p.80+80 CON GAMBE A PONTE bench sliding worktops w 240 x d 80+80 cms with bridge metal legs	18 mm	25 € 1.188,00
153 779 *	BENCH PIANI SCORREVOLI L.280 x p.80+80 CON GAMBE A PONTE bench sliding worktops w 280 x d 80+80 cms with bridge metal legs	18 mm	25 € 1.240,00
153 780 *	BENCH PIANI SCORREVOLI L.320 x p.80+80 CON GAMBE A PONTE bench sliding worktops w 320 x d 80+80 cms with bridge metal legs	18 mm	25 € 1.292,00
153 781 *	BENCH PIANI SCORREVOLI L.360 x p.80+80 CON GAMBE A PONTE bench sliding worktops w 360 x d 80+80 cms with bridge metal legs	18 mm	25 € 1.360,00
153 801 *	GAMBA A PONTE TERMINALE DX PROF. CM 60 (APPOGGIARE SU MOBILE DI SERVIZIO O PORTA-CPU) right terminal bridge leg deep 60 cms (put on service unit or pc-holder)	36	€ 95,00
153 802 *	GAMBA A PONTE TERMINALE SX PROF. CM 60 (APPOGGIARE SU MOBILE DI SERVIZIO O PORTA-CPU) left terminal bridge leg deep 60 cms (put on service unit or pc-holder)	36	€ 95,00
153 803 *	GAMBA A PONTE TERMINALE DX PROF. CM 80 (APPOGGIARE SU MOBILE DI SERVIZIO O PORTA-CPU) right terminal bridge leg deep 80 cms (put on service unit or pc-holder)	36	€ 105,00
153 804 *	GAMBA A PONTE TERMINALE SX PROF. CM 80 (APPOGGIARE SU MOBILE DI SERVIZIO O PORTA-CPU) left terminal bridge leg deep 80 cms (put on service unit or pc-holder)	36	€ 105,00
153 805 *	GAMBA A PONTE TERMINALE PROF. CM 125 (APPOGGIARE SU MOBILE DI SERVIZIO O PORTA-CPU) terminal bridge leg deep 125 cms (put on service unit or pc-holder)	36	€ 126,00
153 806 *	GAMBA A PONTE TERMINALE PROF. CM 165 (APPOGGIARE SU MOBILE DI SERVIZIO O PORTA-CPU) terminal bridge leg deep 165 cms (put on service unit or pc-holder)	36	€ 150,00
153 810 *	PIANO SCRIVANIA L.120 x p.60 desktop w 120 x d 60 cms	18 mm	34 € 44,00
153 811 *	PIANO SCRIVANIA L.140 x p.60 desktop w 140 x d 60 cms	18 mm	34 € 50,00
153 812 *	PIANO SCRIVANIA L.160 x p.60 desktop w 160 x d 60 cms	18 mm	34 € 56,00
153 813 *	PIANO SCRIVANIA L.180 x p.60 desktop w 180 x d 60 cms	18 mm	34 € 61,00
153 815 *	PIANO SCRIVANIA L.120 x p.80 desktop w 120 x d 80 cms	18 mm	34 € 55,00
153 816 *	PIANO SCRIVANIA L.140 x p.80 desktop w 140 x d 80 cms	18 mm	34 € 62,00
153 817 *	PIANO SCRIVANIA L.160 x p.80 desktop w 160 x d 80 cms	18 mm	34 € 68,00
153 818 *	PIANO SCRIVANIA L.180 x p.80 desktop w 180 x d 80 cms	18 mm	34 € 77,00
153 825 *	PIANO TAVOLO RIUNIONE L.160 x p.125,2 meeting tabletop w 160 x d 125,2 cms	18 mm	70 € 132,00
153 826 *	PIANO TAVOLO RIUNIONE L.120 x p.125,2 meeting tabletop w 120 x d 125,2 cms	18 mm	70 € 108,00
153 827 *	PIANO TAVOLO RIUNIONE L.160 x p.165,2 meeting tabletop w 160 x d 165,2 cms	18 mm	70 € 159,00
153 829 *	PIANO TERMINALE PER BENCH PROF. CM 80+80 terminal desktop for bench deep 80+80 cms	18 mm	34 € 72,00
153 871 *	TOP PER CASSETTIERA O STORAGE PROF. CM 60 top for pedestal o storage deep 60 cms	18 mm	60 € 18,00
153 872 *	TOP PER CASSETTIERA O STORAGE PROF. CM 80 top for pedestal or storage deep 80 cms	18 mm	60-62 € 23,00

5TH ELEMENT

\* = INDICARE IL CODICE FINITURA  
= complete with finish code

INDICE DEI CODICI / codes index  
Mod. 9th ELEMENT

CODICE code	DESCRIZIONE description		PAG. page	PREZZO price
153 874 *	TOP PER 2 CASSETTIERE LATERALI O STORAGE L.42 x p.165,2 top for 2 lateral pedestals or storage w 42 x d 165,2 cms	18 mm	60-62	€ 41,00
153 876 *	TOP PER 2 MOBILI LATERALI L.46 x p.165,2 top for 2 lateral cabinets w 46 x d 165,2 cms	18 mm	56	€ 45,00
153 890 *	SCRIVANIA DIREZIONALE L.160 CON GAMBE A PONTE executive desk w 160 cms with bridge legs	18 mm	10	€ 388,00
153 890 *	SCRIVANIA DIREZIONALE L.160 CON GAMBE A PONTE executive desk w 160 cms with bridge legs	18 mm	10	€ 712,00
153 892 *	SCRIVANIA DIREZIONALE L.160 CON GAMBE A "LOOP" executive desk w 160 cms with "loop" legs	18 mm	10	€ 480,00
153 892 *	SCRIVANIA DIREZIONALE L.180 CON GAMBE A "LOOP" executive desk w 180 cms with "loop" legs	18 mm	10	€ 844,00
153 903 *	SCRIVANIA DIREZIONALE L.180 CON GAMBE A PONTE executive desk w 180 cms with bridge legs	18 mm	10	€ 404,00
153 903 *	SCRIVANIA DIREZIONALE L.180 CON GAMBE A PONTE executive desk w 180 cms with bridge legs	18 mm	10	€ 728,00
153 904 *	SCRIVANIA DIREZIONALE L.200 CON GAMBE A PONTE executive desk w 200 cms with bridge legs	18 mm	10	€ 424,00
153 904 *	SCRIVANIA DIREZIONALE L.200 CON GAMBE A PONTE executive desk w 200 cms with bridge legs	18 mm	10	€ 748,00
153 905 *	SCRIVANIA DIREZIONALE L.220 CON GAMBE A PONTE executive desk w 220 cms with bridge legs	18 mm	10	€ 442,00
153 905 *	SCRIVANIA DIREZIONALE L.220 CON GAMBE A PONTE executive desk w 220 cms with bridge legs	18 mm	10	€ 766,00
153 906 *	SCRIVANIA DIREZIONALE L.200 CON GAMBA A PONTE E MOBILE-BASE (DX O SX) executive desk w 200 cms with bridge leg and undertop cabinet (right or left)	18 mm	10	€ 442,00
153 906 *	SCRIVANIA DIREZIONALE L.200 CON GAMBA A PONTE E MOBILE-BASE (DX O SX) executive desk w 200 cms with bridge leg and undertop cabinet (right or left)	18 mm	10	€ 604,00
153 908 *	SCRIVANIA DIREZIONALE L.180 CON GAMBA A PONTE E MOBILE-BASE (DX O SX) executive desk w 180 cms with bridge leg and undertop cabinet (right or left)	18 mm	10	€ 426,00
153 908 *	SCRIVANIA DIREZIONALE L.180 CON GAMBA A PONTE E MOBILE-BASE (DX O SX) executive desk w 180 cms with bridge leg and undertop cabinet (right or left)	18 mm	10	€ 588,00
153 909 *	SCRIVANIA DIREZIONALE L.180 CON GAMBE A "LOOP" executive desk w 180 cms with "loop" legs	18 mm	10	€ 496,00
153 909 *	SCRIVANIA DIREZIONALE L.180 CON GAMBE A "LOOP" executive desk w 180 cms with "loop" legs	18 mm	10	€ 860,00
153 910 *	SCRIVANIA DIREZIONALE L.180 CON GAMBA A "LOOP" E MOBILE-BASE (DX O SX) executive desk w 180 cms with "loop" leg and undertop cabinet (right or left)	18 mm	10	€ 472,00
153 910 *	SCRIVANIA DIREZIONALE L.180 CON GAMBA A "LOOP" E MOBILE-BASE (DX O SX) executive desk w 180 cms with "loop" leg and undertop cabinet (right or left)	18 mm	10	€ 654,00
153 911 *	SCRIVANIA DIREZIONALE L.200 CON GAMBE A "LOOP" executive desk w 200 cms with "loop" legs	18 mm	10	€ 516,00
153 911 *	SCRIVANIA DIREZIONALE L.200 CON GAMBE A "LOOP" executive desk w 200 cms with "loop" legs	18 mm	10	€ 880,00
153 912 *	SCRIVANIA DIREZIONALE L.220 CON GAMBE A "LOOP" executive desk w 220 cms with "loop" legs	18 mm	10	€ 534,00
153 912 *	SCRIVANIA DIREZIONALE L.220 CON GAMBE A "LOOP" executive desk w 220 cms with "loop" legs	18 mm	10	€ 898,00
153 913 *	SCRIVANIA DIREZIONALE L.200 CON GAMBA A "LOOP" E MOBILE-BASE (DX O SX) executive desk w 200 cms with "loop" leg and undertop cabinet (right or left)	18 mm	10	€ 488,00
153 913 *	SCRIVANIA DIREZIONALE L.200 CON GAMBA A "LOOP" E MOBILE-BASE (DX O SX) executive desk w 200 cms with "loop" leg and undertop cabinet (right or left)	18 mm	10	€ 670,00
153 916 *	SCRIVANIA DIREZIONALE L.180 CON GAMBE A PONTE executive desk w 180 cms with bridge legs	10 mm	12	€ 830,00
153 917 *	SCIENIA PER SCRIVANIA DIREZIONALE VETRO L.180 (CON 2 GAMBE METALLICHE E PIANO IN VETRO) modesty panel for executive glass desk w 180 cms (with 2 metal legs and glass top)	18 mm	14	€ 34,00
153 919 *	SCIENIA PER SCRIVANIA DIREZIONALE VETRO L.200 (CON 2 GAMBE METALLICHE E PIANO IN VETRO) modesty panel for executive glass desk w 200 cms (with 2 metal legs and glass top)	18 mm	14	€ 35,00
153 920 *	SCRIVANIA DIREZIONALE L.200 CON GAMBE A PONTE executive desk w 200 cms with bridge legs	10 mm	12	€ 857,00
153 921 *	SCRIVANIA DIREZIONALE L.180 CON GAMBE A "LOOP" executive desk w 180 cms with "loop" legs	10 mm	12	€ 922,00
153 922 *	SCRIVANIA DIREZIONALE L.200 CON GAMBE A "LOOP" executive desk w 200 cms with "loop" legs	10 mm	12	€ 949,00
153 924 *	ALLUNGO L.100CON PIANO IN VETRO E GAMBA A PONTE extension w 100 cms with glass top and bridge leg	10 mm	13	€ 381,00
153 925 *	ALLUNGO L.100 CON PIANO IN VETRO E GAMBA A "LOOP" extension w 100 cms with glass top and "loop" leg	10 mm	13	€ 431,00
153 931 *	SCRIVANIA DIREZIONALE L.180 CON GAMBE A PONTE executive desk w 180 cms with bridge legs	10 mm	12	€ 1.154,00
153 932 *	SCRIVANIA DIREZIONALE L.200 CON GAMBE A PONTE executive desk w 200 cms with bridge legs	10 mm	12	€ 1.181,00
153 934 *	SCRIVANIA DIREZIONALE L.180 CON GAMBE A "LOOP" executive desk w 180 cms with "loop" legs	10 mm	12	€ 1.286,00
153 935 *	SCRIVANIA DIREZIONALE L.200 CON GAMBE A "LOOP" executive desk w 200 cms with "loop" legs	10 mm	12	€ 1.313,00
153 937 *	ALLUNGO L.100CON PIANO IN VETRO E GAMBA A PONTE extension w 100 cms with glass top and bridge leg	10 mm	13	€ 516,00
153 939 *	ALLUNGO L.100 CON PIANO IN VETRO E GAMBA A "LOOP" extension w 100 cms with glass top and "loop" leg	10 mm	13	€ 606,00
175 105 *	5' OPZIONALE PER CASSETTIERA CLASSIFICATORE fifth optional wheel for file-pedestal		58	€ 13,00
175 117 *	2 PRESE STANDARD ITALIA/GERMANIA SCHUKO+ 2 CHARGER USB + 1 TAPPO 2 Italy/Germany SCHUKO standard sockets+2 charger USB + 1 cap	K1	64	€ 257,00
175 118 *	2 PRESE STANDARD FRANCIA+ 2 CHARGER USB + 1 TAPPO 2 FRANCE standard sockets+2 charger USB + 1 cap	K1	64	€ 243,00
175 119 *	2 PRESE STANDARD INGLESE+ 2 CHARGER USB + 1 TAPPO 2 BRITISH standard sockets+2 charger USB + 1 cap	K1	64	€ 270,00
175 120 *	2 PRESE STANDARD ITALIA/GERMANIA SCHUKO+ 2 CHARGER USB + 1 TAPPO 2 Italy/Germany SCHUKO standard sockets+2 charger USB + 1 cap	K2	64	€ 317,00
175 121 *	2 PRESE STANDARD FRANCIA+ 2 CHARGER USB + 1 TAPPO 2 FRANCE standard sockets+2 charger USB + 1 cap	K2	64	€ 285,00
175 122 *	2 PRESE STANDARD INGLESE+ 2 CHARGER USB + 1 TAPPO 2 BRITISH standard sockets+2 charger USB + 1 cap	K2	64	€ 343,00
175 123 *	1 RJ45 CAT.6		64	€ 39,00
175 124 *	2 RJ45 CAT.6		64	€ 73,00
175 125 *	1 RJ45CAT.6 + 1 HDMI		64	€ 73,00



LISTINO 2018  
PRICE LIST

UP

# UP

DESK  
ELEVATION  
SYSTEM

Conforme al DLGS 81/2008 (già 626/'94)  
apply to RULE 81/2008 (626/'94)

### IMPORTANTE / it's very important

SULL'ORDINE INDICARE SEMPRE IL CODICE COMPLETO A 9 CIFRE  
always indicate on the order the complete 9-digit code

ESEMPIO: PER ORDINARE 1 SCRIVANIA **ART.018** NOCE PAVIA INDICARE IL CODICE =  
example: to order 1 DESK **ART.018** PAVIA WALNUT indicate the code =

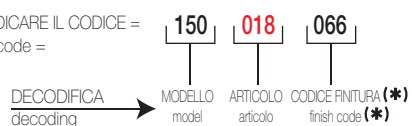

Certificato 04/16

In vigore dal:  
Valid from:  
01/01/2018

Valido fino a nuova emissione  
Valid until new emission

## SOMMARIO / summary

<b>CARTELLA COLORI</b> .....	<b>3</b>
<i>colours samples card</i>	
<b>SCRIVANIE GAMBE A PONTE CON ALTEZZA REGOLABILE H.65÷85 (con pomo o manovella)</b> .....	<b>8</b>
<i>desks bridge legs with adjustable height h 65÷85 cms (with knob or crank)</i>	
<b>SCRIVANIE GAMBE A "T" CON ALTEZZA REGOLABILE H.65÷85 (con pomo o manovella)</b> .....	<b>9</b>
<i>desks "T" legs with adjustable height h 65÷85 cms- (with knob or crank)</i>	
<b>SCRIVANIE GAMBE A "T" CON ALTEZZA REGOLABILE H.62÷128 (con sistema motorizzato)</b> .....	<b>10</b>
<i>desks "T" legs with adjustable height h 62÷128 cms (with automatic system)</i>	
<b>CANALI PORTA-CAVI PER SCRIVANIE GAMBE A "T" (con sistema motorizzato)</b> .....	<b>11</b>
<i>cable trays for desks "T" legs (with automatic system)</i>	
<b>ELEMENTI DI RICAMBIO PER SCRIVANIE GAMBE A "T" (con sistema motorizzato)</b> .....	<b>11</b>
<i>spare parts for desks "T" legs (with automatic system)</i>	
<b>SCHIENE (OPTIONAL)</b> .....	<b>12</b>
<i>modesty panels (optional)</i>	
<b>KIT PRESE (OPTIONAL)</b> .....	<b>12</b>
<i>sockets kit (optional)</i>	
<b>DESCRIZIONE TECNICA mod. UP</b> .....	<b>13</b>
<b>TECHNICAL DESCRIPTION mod. UP</b> .....	<b>14</b>
<b>INDICE DEI CODICI</b> .....	<b>15</b>
<i>codes index</i>	

**N.B.: CASSETTIERE SU RUOTE, MOBILI CONTENITORI  
E LIBRERIE A SPALLA UNICA  
SONO INSERITI NEL CAPITOLO "CONTENITORI UNIVERSALI EVO"**  
*PLEASE NOTE: you can find pedestal on wheels, cabinet models  
and bookcases with shared side panel in the section "UNIVERSAL CABINETS EVO"*

**CARTELLA COLORI**  
colours samples card



**COD. 01**  
ARGENTO GOLF | GOLF SILVER



**COD. 03**  
ROVERE | OAK



**COD. 04**  
ROVERE GREY | GREY OAK



**COD. 06**  
NOCE PAVIA | PAVIA WALNUT



**COD. 42**  
GRIGIO | GREY



**COD. 44**  
STONE GREY | STONE GREY



**COD. 45**  
WENGÉ | WENGÉ



**COD. 58**  
ACERO TAKI | TAKI MAPLE

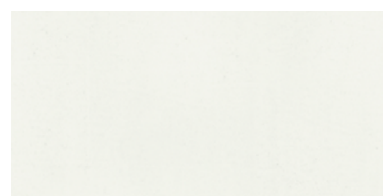

**COD. 69**  
BIANCO BR. | BR. WHITE

UP

**RIVESTIMENTI IN TESSUTO PER PANNELLI FRONTALI BENCH**  
fabric for front panels for BENCH

**Cat. F**



**POLIESTERE STRETCH IGNIFUGO**  
100% poliestere FR riciclato  
Martindale 50.000

**FIRE-RETARDANT STRETCH POLYESTER**  
100% polyester FR recycled  
Martindale 50.000

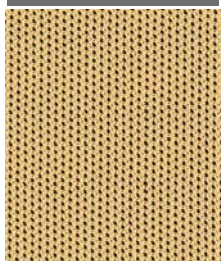

**321**  
GIALLO FRESIA | FREESIA YELLOW



**320**  
AZZURRO SKY | SKY BLUE



**322**  
AMARANTO | AMARANTH



**323**  
VERDE BOSCO | WOOD GREEN



**327**  
GRIGIO | GREY

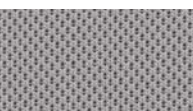

**328**  
TORTORA | GREY BEIGE



**330**  
MATTONE | BRICK RED



**331**  
ARANCIO | ORANGE



**332**  
ROSSO | RED



**333**  
VERDE ACIDO | ACID GREEN



**334**  
BLU | BLUE

**SCRIVANIE GAMBE A PONTE CON ALTEZZA REGOLABILE H.65÷85 (con pomo o manovella)**  
**desks bridge legs with adjustable height h 65÷85 cms (with knob or crank)**

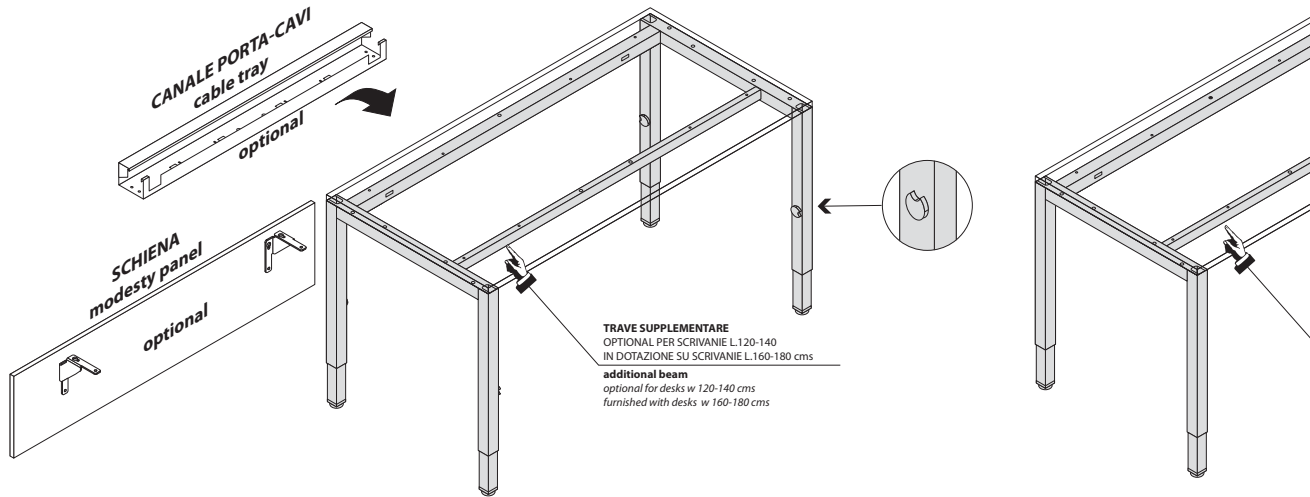

**SCRIVANIE GAMBE "T" CON ALTEZZA REGOLABILE H.65÷85 (con pomo o manovella)**  
**desks "T" legs with adjustable height h 65÷85 cms (with knob or crank)**

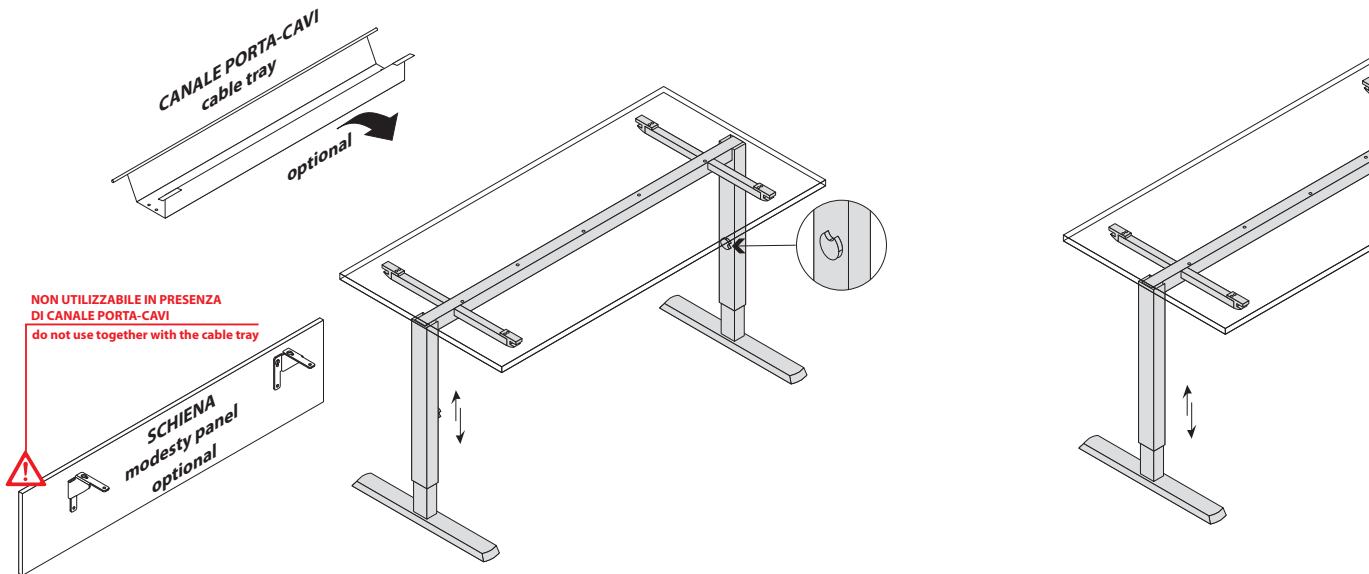

**SCRIVANIE GAMBE "T" CON ALTEZZA REGOLABILE H.62÷128 (con sistema motorizzato)**  
**desks "T" legs with adjustable height h 62÷128 cms (with automatic system)**

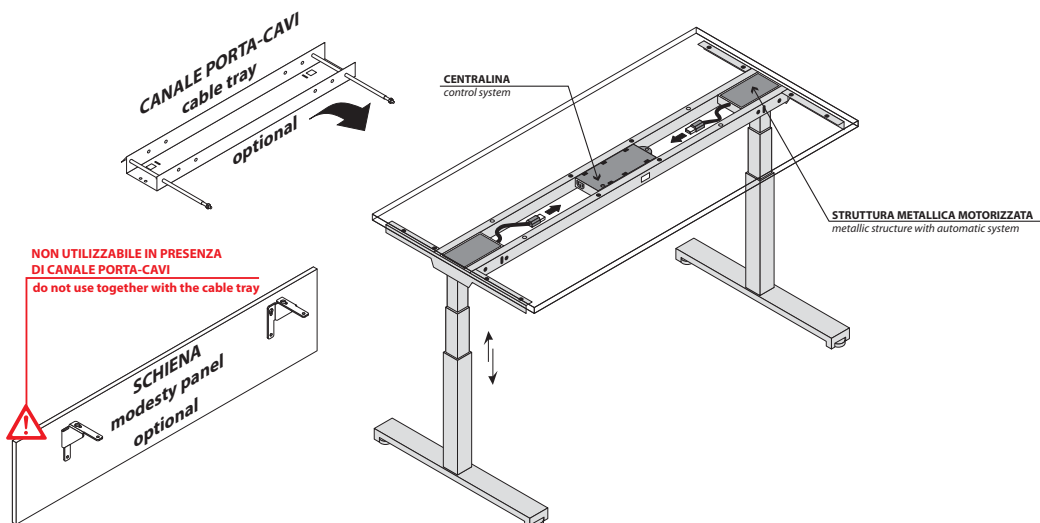

**SCRIVANIA COMPLETA DI:  
 STRUTTURA METALLICA MOTO  
 ATTENZIONE!  
 COMPLETARE SEMPRE CON PU**

desk with:  
 metallic structure with automatic s  
**ATTENTION!**  
 to be always completed with contr



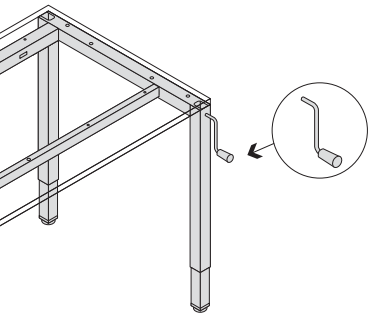

**TRAVE SUPPLEMENTARE**  
OPTIONAL PER SCRIVANIE L.120-140  
IN DOTAZIONE SU SCRIVANIE L.160-180-200

**additional beam**  
optional for desks w 120-140  
furnished with desks w 160-180 cms

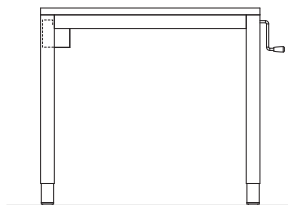

**BENCH CON ALTEZZA REGOLABILE H.65+85 (con manovella)**  
**BENCH with adjustable height h 65+85 cms (with crank)**

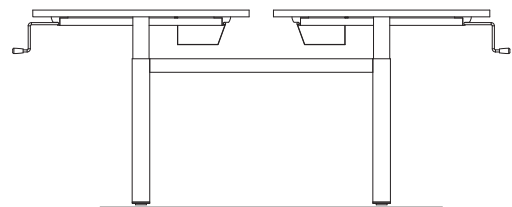
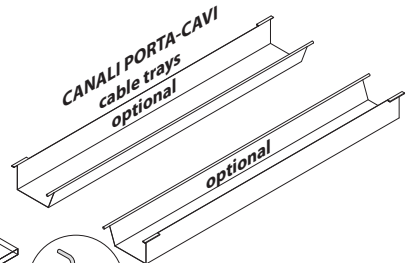
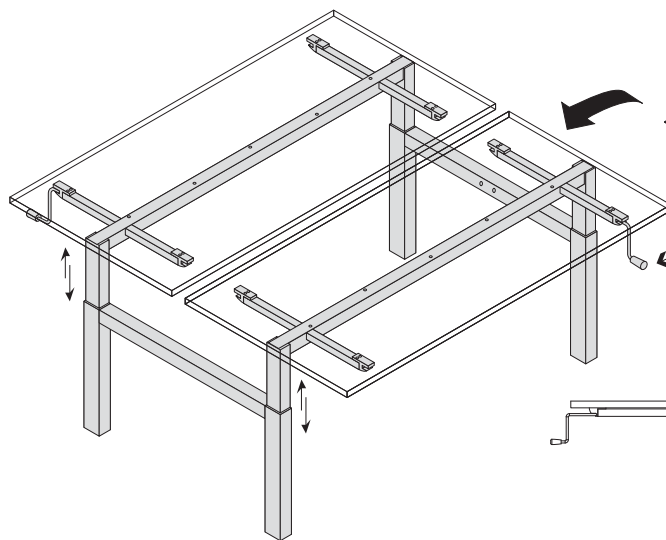
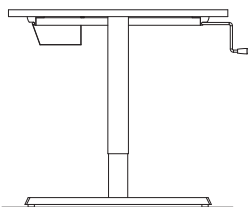
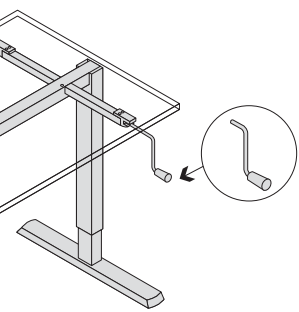

**ALTEZZA REGOLABILE, CENTRALINA E PIANO DI LAVORO**

**ALTEZZA REGOLABILE, CENTRALINA E PIANO DI LAVORO**  
**ALTEZZA REGOLABILE, CENTRALINA E PIANO DI LAVORO**

control system, control system and work top

control panel up/down ART.680 or ART.681 + power cable art.690



ART.681



ART.690

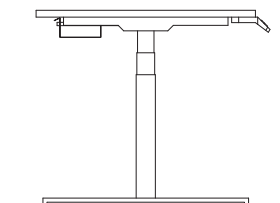

**SCRIVANIE GAMBE A PONTE CON ALTEZZA REGOLABILE H.65÷85 (con pomo o manovella)**  
**desks bridge legs with adjustable height h 65÷85 cms (with knob or crank)**



**• STRUTTURA METALLICA CON GAMBE A PONTE**

Gambe e 2 travi portanti realizzate in tubolare metallico a sezione quadrata 50x50mm. Verniciatura a polveri epossidiche nel colore ARGENTO o BIANCO. Le gambe sono dotate di piedini livellatori. La regolazione in altezza avviene con sistema a pomo "A" o a manovella "B"

**• METAL STRUCTURE WITH BRIDGE LEGS**

Legs and 2 supporting beams made of metallic tubular with squared section 50x50 mm. Painted with epoxy resin powder in SILVER or WHITE colour. The legs include adjustable feet. Adjustable-height with knob "A" or crank "B" system.



**• PIANI DI LAVORO**

Realizzati con pannelli di particelle di legno sp. 25mm nobilitati in melaminico nei colori: ROVERE 03, ROVERE GREY 04, NOCE PAVIA 06, GRIGIO 42, STONE GREY 44, WENGE' 45, ACERO TAKI 58, BIANCO BR. 69. Rifiniti perimentalmente con bordo in ABS spessore 2mm in tinta con la superficie.

**• WORK TOPS**

Made of particleboard panels 25mm thick, melamine-faced in the following colours: OAK 03, GREY OAK 04, PAVIA WALNUT 06, GREY 42, STONE GREY 44, WENGE' 45, TAKI MAPLE 58, BR. WHITE 69. Edge-finishing in 2 mm ABS matching the main shade.



**• CANALE PORTA-CAVI**

Realizzato in lamiera metallica spessore 1 mm. Verniciato a polveri epossidiche nel colore ARGENTO o BIANCO. L'aggancio avviene sulla trave più esterna (lato visitatore)

**• CABLE TRAY**

Made of metallic sheet thick 1 mm. Painted with epoxy resin powder in SILVER or WHITE colour. Hook on the external beam (guest side).





**SCRIVANIE GAMBE A "T" CON ALTEZZA REGOLABILE H.65÷85 (con pomo o manovella)**  
**desks "T" legs with adjustable height h 65÷85 cms (with knob or crank)**



**• STRUTTURA METALLICA CON GAMBE A "T"**

Tubolari verticali metallici a sezione rettangolare 75x55mm idonei al fissaggio della trave centrale a sezione quadrata 50x50mm.  
 Verniciatura a polveri epossidiche nel colore ARGENTO o BIANCO. Le gambe sono dotate di piedini livellatori.  
 La regolazione in altezza avviene con sistema a pomo "A" o a manovella "B"

**• METAL STRUCTURE WITH "T" LEGS**

Metal vertical tubular with rectangular section 75x55 mm for fixing central beam with squared section 50x50 mm.  
 Painted with epoxy resin powder in SILVER or WHITE colour.  
 The legs include adjustable feet.  
 Adjustable-height with knob "A" or crank "B" system.

**• PIANI DI LAVORO**

Realizzati con pannelli di particelle di legno sp. 25mm nobilitati in melaminico nei colori: ROVERE 03, ROVERE GREY 04, NOCE PAVIA 06, GRIGIO 42, STONE GREY 44, WENGE' 45, ACERO TAKI 58, BIANCO BR. 69  
 Rifiniti perimetricamente con bordo in ABS spessore 2mm in tinta con la superficie.

**• WORK TOPS**

Made of particleboard panels 25mm thick. melamine-faced in the following colours: OAK 03, GREY OAK 04, PAVIA WALNUT 06, GREY 42, STONE GREY 44, WENGE' 45, TAKI MAPLE 58, BR. WHITE 69.  
 Edge-finishing in 2 mm ABS matching the main shade.



UP

**BENCH CON ALTEZZA REGOLABILE H.65÷85 (con manovella)**  
**BENCH with adjustable height h 65÷85 cms (with crank)**

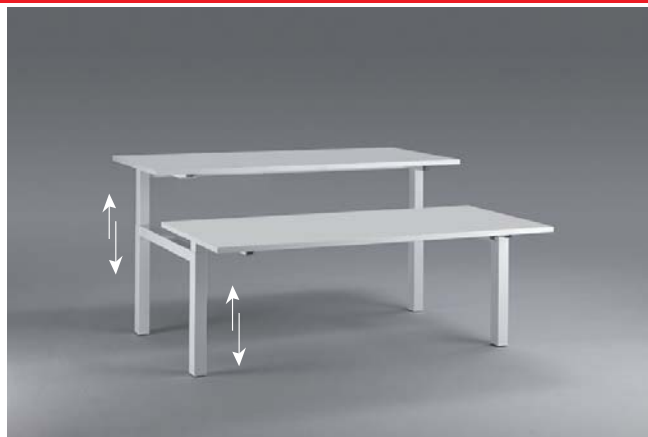

**• STRUTTURA METALLICA CON GAMBE A PONTE**

Gambe e 2 travi portanti centrali realizzate in tubolare metallico a sezione quadrata 50x50mm.  
 Verniciatura a polveri epossidiche nel colore ARGENTO o BIANCO. Le gambe sono dotate di piedini livellatori.  
 La regolazione in altezza avviene con sistema a manovella "B" in modalità indipendente fra i 2 piani.

**• METAL STRUCTURE WITH BRIDGE LEGS**

Legs and 2 central supporting beams made of metallic tubular with squared section 50x50 mm.  
 Painted with epoxy resin powder in SILVER or WHITE colour.  
 The legs include adjustable feet.  
 The height is adjusted with use of a crank system "B" in an independent way for each top.

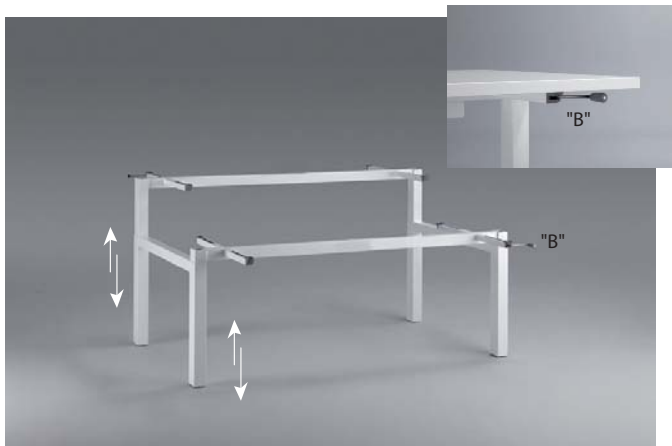

**• CANALE PORTA-CAVI**

Realizzato in lamiera metallica spessore mm 1.  
 Verniciato a polveri epossidiche nel colore ARGENTO o BIANCO.  
 L'aggancio avviene sulle 2 estremità delle traverse.

**• CABLE TRAY**

Made of metallic sheet thick 1 mm.  
 Painted with epoxy resin powder in SILVER or WHITE colour.  
 Hook in the end points of the crossways.



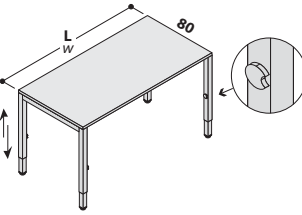
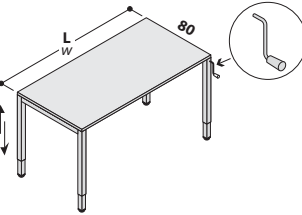
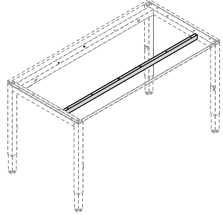
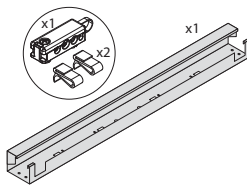

**SCRIVANIE GAMBE A PONTE CON ALTEZZA REGOLABILE H.65÷85 (con pomo o manovella)**PIANI sp. 25mm  
tops thick. 25mmdesks bridge legs with adjustable height *h 65÷85 cms (with knob or crank)*

DESCRIZIONE <i>description</i>	L <i>w</i>	L <i>w</i>	CODICE <i>code</i>	KG 	M <sup>3</sup> 	COLLI 	PREZZO <i>price</i>	(*) CODICE FINITURA <i>(*) finish code</i>																																																																																					
SCRIVANIE PROF. CM 80 <i>desks deep 80 cms</i>    L. x p.80 x H.65÷85																																																																																													
		L.120	150 018 (*)	31	0,209	3	€ 484,00																																																																																						
		L.140	150 019 (*)	35	0,218	3	€ 500,00																																																																																						
		L.160	150 020 (*)	40	0,226	3	€ 542,00																																																																																						
		L.180	150 021 (*)	44	0,234	3	€ 560,00																																																																																						
								<table border="1"> <thead> <tr> <th>(*)</th> <th>PIANI</th> <th>STRUTTURA</th> <th>tops</th> <th>structure</th> </tr> </thead> <tbody> <tr><td>003</td><td>ROVERE</td><td>ARGENTO</td><td>oak</td><td>silver</td></tr> <tr><td>004</td><td>ROVERE GREY</td><td>ARGENTO</td><td>grey oak</td><td>silver</td></tr> <tr><td>020</td><td>ACERO TAKI</td><td>ARGENTO</td><td>taki maple</td><td>silver</td></tr> <tr><td>030</td><td>GRIGIO</td><td>ARGENTO</td><td>grey</td><td>silver</td></tr> <tr><td>040</td><td>BIANCO BR.</td><td>ARGENTO</td><td>br. white</td><td>silver</td></tr> <tr><td>044</td><td>STONE GREY</td><td>ARGENTO</td><td>stone grey</td><td>silver</td></tr> <tr><td>066</td><td>NOCE PAVIA</td><td>ARGENTO</td><td>pavia walnut</td><td>silver</td></tr> <tr><td>090</td><td>WENGE'</td><td>ARGENTO</td><td>wenge</td><td>silver</td></tr> <tr><td>400</td><td>BIANCO BR.</td><td>BIANCO</td><td>br. white</td><td>white</td></tr> <tr><td>403</td><td>ROVERE</td><td>BIANCO</td><td>oak</td><td>white</td></tr> <tr><td>404</td><td>ROVERE GREY</td><td>BIANCO</td><td>grey oak</td><td>white</td></tr> <tr><td>420</td><td>ACERO TAKI</td><td>BIANCO</td><td>taki maple</td><td>white</td></tr> <tr><td>430</td><td>GRIGIO</td><td>BIANCO</td><td>grey</td><td>white</td></tr> <tr><td>444</td><td>STONE GREY</td><td>BIANCO</td><td>stone grey</td><td>white</td></tr> <tr><td>466</td><td>NOCE PAVIA</td><td>BIANCO</td><td>pavia walnut</td><td>white</td></tr> <tr><td>490</td><td>WENGE'</td><td>BIANCO</td><td>wenge</td><td>white</td></tr> </tbody> </table>	(*)	PIANI	STRUTTURA	tops	structure	003	ROVERE	ARGENTO	oak	silver	004	ROVERE GREY	ARGENTO	grey oak	silver	020	ACERO TAKI	ARGENTO	taki maple	silver	030	GRIGIO	ARGENTO	grey	silver	040	BIANCO BR.	ARGENTO	br. white	silver	044	STONE GREY	ARGENTO	stone grey	silver	066	NOCE PAVIA	ARGENTO	pavia walnut	silver	090	WENGE'	ARGENTO	wenge	silver	400	BIANCO BR.	BIANCO	br. white	white	403	ROVERE	BIANCO	oak	white	404	ROVERE GREY	BIANCO	grey oak	white	420	ACERO TAKI	BIANCO	taki maple	white	430	GRIGIO	BIANCO	grey	white	444	STONE GREY	BIANCO	stone grey	white	466	NOCE PAVIA	BIANCO	pavia walnut	white	490	WENGE'	BIANCO	wenge	white
(*)	PIANI	STRUTTURA	tops	structure																																																																																									
003	ROVERE	ARGENTO	oak	silver																																																																																									
004	ROVERE GREY	ARGENTO	grey oak	silver																																																																																									
020	ACERO TAKI	ARGENTO	taki maple	silver																																																																																									
030	GRIGIO	ARGENTO	grey	silver																																																																																									
040	BIANCO BR.	ARGENTO	br. white	silver																																																																																									
044	STONE GREY	ARGENTO	stone grey	silver																																																																																									
066	NOCE PAVIA	ARGENTO	pavia walnut	silver																																																																																									
090	WENGE'	ARGENTO	wenge	silver																																																																																									
400	BIANCO BR.	BIANCO	br. white	white																																																																																									
403	ROVERE	BIANCO	oak	white																																																																																									
404	ROVERE GREY	BIANCO	grey oak	white																																																																																									
420	ACERO TAKI	BIANCO	taki maple	white																																																																																									
430	GRIGIO	BIANCO	grey	white																																																																																									
444	STONE GREY	BIANCO	stone grey	white																																																																																									
466	NOCE PAVIA	BIANCO	pavia walnut	white																																																																																									
490	WENGE'	BIANCO	wenge	white																																																																																									
SCRIVANIE PROF. CM 80 <i>desks deep 80 cms</i>    L. x p.80 x H.65÷85																																																																																													
		L.120	150 080 (*)	33	0,209	3	€ 936,00																																																																																						
		L.140	150 081 (*)	36	0,218	3	€ 953,00																																																																																						
		L.160	150 082 (*)	41	0,226	3	€ 1.001,00																																																																																						
		L.180	150 083 (*)	45	0,234	3	€ 1.020,00																																																																																						
TRAVE SUPPLEMENTARE (OPTIONAL) PER SCRIVANIE <i>additional beam (optional) for desks</i>    L. x p.2,5 x H.4																																																																																													
	L. TRAVE <i>w beam</i>	UTILIZZARE SU PIANI <i>use for desktop</i>																																																																																											
	L.110,4	L.120	150 115 (*)	3	0,027	1	€ 29,00																																																																																						
L.130,4	L.140	150 116 (*)	3,5	0,029	1	€ 31,00																																																																																							
CANALI PORTA-CAVI BASCULANTE +1 FISSAGGIO CAVI + 2 CLIP FERMACAVI (SOLO PER SCRIVANIE CON GAMBE A PONTE) <i>tilting cable trays + 1 fixing cable + 2 plastic cable clamp</i> <i>(for desks with bridge legs only)</i>    L. x p.11 x H.10																																																																																													
	L. PORTACAVI <i>w cable tray</i>	UTILIZZARE SU PIANI <i>use for desktop</i>																																																																																											
	L.80,4	L.120	150 120 (*)	2	0,040	1	€ 48,00																																																																																						
	L.100,4	L.140	150 121 (*)	3,2	0,034	1	€ 52,00																																																																																						
	L.120,4	L.160	150 122 (*)	3,5	0,034	1	€ 59,00																																																																																						
L.140,4	L.180	150 123 (*)	4	0,034	1	€ 65,00																																																																																							
								<table border="1"> <thead> <tr> <th>(*)</th> <th>PIANI</th> <th>STRUTTURA</th> <th>tops</th> <th>structure</th> </tr> </thead> <tbody> <tr><td>000</td><td>ARGENTO</td><td></td><td></td><td>silver</td></tr> <tr><td>400</td><td>BIANCO</td><td></td><td></td><td>white</td></tr> </tbody> </table>	(*)	PIANI	STRUTTURA	tops	structure	000	ARGENTO			silver	400	BIANCO			white																																																																						
(*)	PIANI	STRUTTURA	tops	structure																																																																																									
000	ARGENTO			silver																																																																																									
400	BIANCO			white																																																																																									

**SCRIVANIE GAMBE A "T" CON ALTEZZA REGOLABILE H.65÷85 (con pomo o manovella)**PIANI sp. 25mm  
tops thick. 25mm

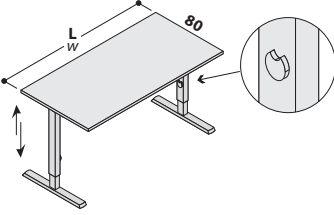
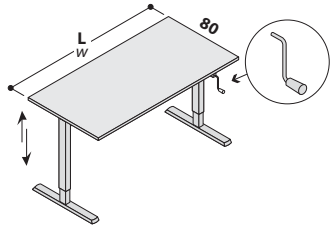
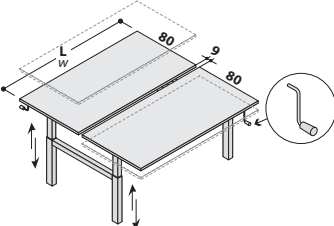
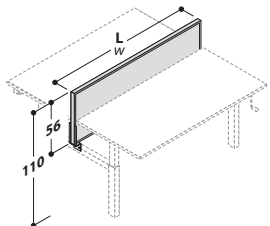
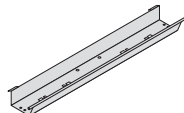
desks "T" legs with adjustable height h 65÷85 cms- (with knob or crank)

DESCRIZIONE description	L w	L w	CODICE code	KG	M <sup>3</sup>	COLLI	PREZZO price	(*) CODICE FINITURA (*) finish code																																																																																				
<b>SCRIVANIE PROF. CM 80</b> desks deep 80 cms 		L120	150 <b>318</b> (*)	34	0,235	3	€ 502,00																																																																																					
		L140	150 <b>319</b> (*)	38	0,247	3	€ 512,00																																																																																					
		L160	150 <b>320</b> (*)	41,5	0,265	3	€ 526,00																																																																																					
		L180	150 <b>321</b> (*)	45	0,281	3	€ 546,00																																																																																					
	L. x p.80 x H.65÷85																																																																																											
<b>SCRIVANIE PROF. CM 80</b> desks deep 80 cms 		L120	150 <b>380</b> (*)	34	0,235	3	€ 769,00																																																																																					
		L140	150 <b>381</b> (*)	38	0,247	3	€ 782,00																																																																																					
		L160	150 <b>382</b> (*)	41,5	0,265	3	€ 797,00																																																																																					
		L180	150 <b>383</b> (*)	45	0,281	3	€ 820,00																																																																																					
	L. x p.80 x H.65÷85																																																																																											
<b>BENCH</b> bench 		L160	150 <b>398</b> (*)	85	0,317	8	€ 1.584,00																																																																																					
		L180	150 <b>399</b> (*)	92	0,349	8	€ 1.630,00																																																																																					
	La regolazione in altezza avviene con sistema a manovella in modalità indipendente fra i 2 piani. Completare con 2 canali porta-cavi (OPTIONAL). The height is adjusted with use of a crank system in an independent way for each top. Complete with 2 cable trays (OPTIONAL).																																																																																											
	L. x p.169 x H.65÷85																																																																																											
<b>PANNELLI FRONTALI PER BENCH</b> front panels for bench 			<b>TESSUTO fabric</b>	<b>PROFILO PERIMETRALE E STAFFE METALLICHE COLORE ARGENTO</b> edge profile and stirrups colour: silver			(*)	<b>TESSUTO POLIESTERE STRETCH IGNIFUGO</b> fire-retardant stretch polyester fabric																																																																																				
		L160	150 <b>408</b> (*)	15	0,053	2	€ 524,00	<b>320</b> AZZURRO SKY sky blue																																																																																				
		L180	150 <b>409</b> (*)	17	0,059	2	€ 585,00	<b>321</b> GIALLO FRESIA freesia yellow																																																																																				
								<b>322</b> AMARANTO amaranth																																																																																				
								<b>323</b> VERDE BOSCO wood green																																																																																				
								<b>327</b> GRIGIO grey																																																																																				
								<b>328</b> TORTORA grey beige																																																																																				
								<b>330</b> MATTONE brick red																																																																																				
								<b>331</b> ARANCIO orange																																																																																				
								<b>332</b> ROSSO red																																																																																				
	L160	150 <b>411</b> (*)	15	0,053	2	€ 524,00	<b>333</b> VERDE ACIDO acid green																																																																																					
	L180	150 <b>412</b> (*)	17	0,059	2	€ 585,00	<b>334</b> BLU blue																																																																																					
L. x p.4 x H.56																																																																																												
<b>CANALI PORTA-CAVI PER SCRIVANIE E BENCH</b> cable trays for desks and bench 		<b>L. PORTACAVI w cable tray</b>	<b>UTILIZZARE SU PIANI use for desktop</b>																																																																																									
		L.81,7	L120	150 <b>420</b> (*)	2,5	0,040	1	€ 68,00																																																																																				
		L.101,7	L140	150 <b>421</b> (*)	3	0,034	1	€ 77,00																																																																																				
		L.121,7	L160	150 <b>422</b> (*)	3,5	0,034	1	€ 82,00																																																																																				
		L.141,7	L180	150 <b>423</b> (*)	4	0,049	1	€ 95,00																																																																																				
	 <b>NON UTILIZZABILE IN PRESENZA DI SCHIENA</b> <b>DO NOT USE TOGETHER WITH THE MODESTY PANEL</b>																																																																																											
L. x p.19 x H.10																																																																																												
<table border="1"> <thead> <tr> <th>(*)</th> <th>PIANI</th> <th>STRUTTURA</th> <th>tops</th> <th>structure</th> </tr> </thead> <tbody> <tr><td>003</td><td>ROVERE</td><td>ARGENTO</td><td>oak</td><td>silver</td></tr> <tr><td>004</td><td>ROVERE GREY</td><td>ARGENTO</td><td>grey oak</td><td>silver</td></tr> <tr><td>020</td><td>ACERO TAKI</td><td>ARGENTO</td><td>taki maple</td><td>silver</td></tr> <tr><td>030</td><td>GRIGIO</td><td>ARGENTO</td><td>grey</td><td>silver</td></tr> <tr><td>040</td><td>BIANCO BR.</td><td>ARGENTO</td><td>br. white</td><td>silver</td></tr> <tr><td>044</td><td>STONE GREY</td><td>ARGENTO</td><td>stone grey</td><td>silver</td></tr> <tr><td>066</td><td>NOCE PAVIA</td><td>ARGENTO</td><td>pavia walnut</td><td>silver</td></tr> <tr><td>090</td><td>WENGE'</td><td>ARGENTO</td><td>wenge</td><td>silver</td></tr> <tr><td>400</td><td>BIANCO BR.</td><td>BIANCO</td><td>br. white</td><td>white</td></tr> <tr><td>403</td><td>ROVERE</td><td>BIANCO</td><td>oak</td><td>white</td></tr> <tr><td>404</td><td>ROVERE GREY</td><td>BIANCO</td><td>grey oak</td><td>white</td></tr> <tr><td>420</td><td>ACERO TAKI</td><td>BIANCO</td><td>taki maple</td><td>white</td></tr> <tr><td>430</td><td>GRIGIO</td><td>BIANCO</td><td>grey</td><td>white</td></tr> <tr><td>444</td><td>STONE GREY</td><td>BIANCO</td><td>stone grey</td><td>white</td></tr> <tr><td>466</td><td>NOCE PAVIA</td><td>BIANCO</td><td>pavia walnut</td><td>white</td></tr> <tr><td>490</td><td>WENGE'</td><td>BIANCO</td><td>wenge</td><td>white</td></tr> </tbody> </table>								(*)	PIANI	STRUTTURA	tops	structure	003	ROVERE	ARGENTO	oak	silver	004	ROVERE GREY	ARGENTO	grey oak	silver	020	ACERO TAKI	ARGENTO	taki maple	silver	030	GRIGIO	ARGENTO	grey	silver	040	BIANCO BR.	ARGENTO	br. white	silver	044	STONE GREY	ARGENTO	stone grey	silver	066	NOCE PAVIA	ARGENTO	pavia walnut	silver	090	WENGE'	ARGENTO	wenge	silver	400	BIANCO BR.	BIANCO	br. white	white	403	ROVERE	BIANCO	oak	white	404	ROVERE GREY	BIANCO	grey oak	white	420	ACERO TAKI	BIANCO	taki maple	white	430	GRIGIO	BIANCO	grey	white	444	STONE GREY	BIANCO	stone grey	white	466	NOCE PAVIA	BIANCO	pavia walnut	white	490	WENGE'	BIANCO	wenge	white
(*)	PIANI	STRUTTURA	tops	structure																																																																																								
003	ROVERE	ARGENTO	oak	silver																																																																																								
004	ROVERE GREY	ARGENTO	grey oak	silver																																																																																								
020	ACERO TAKI	ARGENTO	taki maple	silver																																																																																								
030	GRIGIO	ARGENTO	grey	silver																																																																																								
040	BIANCO BR.	ARGENTO	br. white	silver																																																																																								
044	STONE GREY	ARGENTO	stone grey	silver																																																																																								
066	NOCE PAVIA	ARGENTO	pavia walnut	silver																																																																																								
090	WENGE'	ARGENTO	wenge	silver																																																																																								
400	BIANCO BR.	BIANCO	br. white	white																																																																																								
403	ROVERE	BIANCO	oak	white																																																																																								
404	ROVERE GREY	BIANCO	grey oak	white																																																																																								
420	ACERO TAKI	BIANCO	taki maple	white																																																																																								
430	GRIGIO	BIANCO	grey	white																																																																																								
444	STONE GREY	BIANCO	stone grey	white																																																																																								
466	NOCE PAVIA	BIANCO	pavia walnut	white																																																																																								
490	WENGE'	BIANCO	wenge	white																																																																																								

UP

**SCRIVANIE GAMBE A "T" CON ALTEZZA REGOLABILE H.62÷128 (con sistema motorizzato)**PIANI sp. 25mm  
tops thick. 25mm



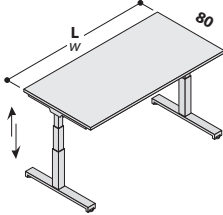
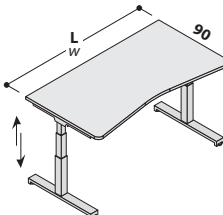
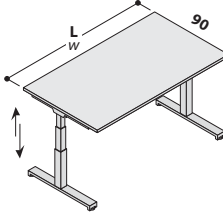
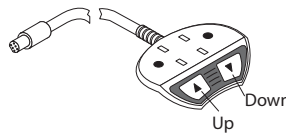
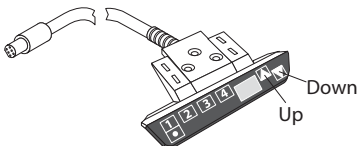
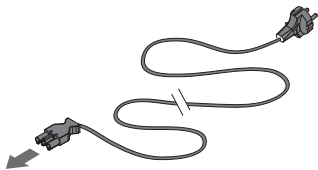



desks "T" legs with adjustable height h 62÷128 cms (with automatic system)





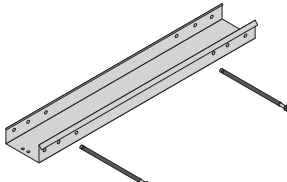

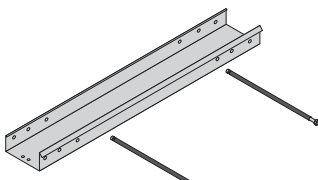
DESCRIZIONE description	L w	CODICE code	KG	M <sup>3</sup>	COLLI	PREZZO price	(*) CODICE FINITURA (*) finish code					
<b>SCRIVANIE PROF. CM 80</b> desks deep 80 cms  L. x p.80 x H.62÷128	L.120	150 618 (*)	40	0,235	3	€ 1.393,00						
	L.140	150 619 (*)	44	0,247	3	€ 1.408,00						
	L.160	150 620 (*)	47,5	0,265	3	€ 1.423,00						
	L.180	150 621 (*)	51	0,281	3	€ 1.443,00						
	<b>COMPLETARE SEMPRE</b> <b>CON PULSANTIERA ART.680 oppure ART.681+CAVO DI ALIMENTAZIONE ART.690</b> <i>always complete with control panel up/down art.680 or art.681+power cable art.690</i>											
<b>SCRIVANIE SAGOMATE PROF. CM 90</b> shaped desks deep 90 cms  L. x p.90 x H.62÷128	L.160	150 638 (*)	44,5	0,288	3	€ 1.459,00						
	<b>COMPLETARE SEMPRE</b> <b>CON PULSANTIERA ART.680 oppure ART.681+CAVO DI ALIMENTAZIONE ART.690</b> <i>always complete with control panel up/down art.680 or art.681+power cable art.690</i>											
								(*)	PIANI	STRUTTURA	tops	structure
								003	ROVERE	ARGENTO	oak	silver
								004	ROVERE GREY	ARGENTO	grey oak	silver
								020	ACERO TAKI	ARGENTO	taki maple	silver
								030	GRIGIO	ARGENTO	grey	silver
								040	BIANCO BR.	ARGENTO	br. white	silver
								044	STONE GREY	ARGENTO	stone grey	silver
								066	NOCE PAVIA	ARGENTO	pavia walnut	silver
								090	WENGE'	ARGENTO	wenge	silver
								400	BIANCO BR.	BIANCO	br. white	white
								403	ROVERE	BIANCO	oak	white
							404	ROVERE GREY	BIANCO	grey oak	white	
							420	ACERO TAKI	BIANCO	taki maple	white	
							430	GRIGIO	BIANCO	grey	white	
							444	STONE GREY	BIANCO	stone grey	white	
							466	NOCE PAVIA	BIANCO	pavia walnut	white	
							490	WENGE'	BIANCO	wenge	white	
<b>SCRIVANIE PROF. CM 90</b> desks deep 90 cms  L. x p.90 x H.62÷128	L.180	150 639 (*)	45	0,281	3	€ 1.454,00						
	L.200	150 640 (*)	47	0,287	3	€ 1.468,00						
<b>COMPLETARE SEMPRE</b> <b>CON PULSANTIERA ART.680 oppure ART.681+CAVO DI ALIMENTAZIONE ART.690</b> <i>always complete with control panel up/down art.680 or art.681+power cable art.690</i>												
<b>PULSANTIERA UP/DOWN</b> control panel up/down 		150 680 (*)	1,5	0,001	1	€ 22,00						
								(*)				
<b>PULSANTIERA UP/DOWN "COMFORT"</b> control panel up/down "COMFORT" 		150 681 (*)	1,5	0,001	1	€ 95,00						
								(*)				
<b>CAVO DI ALIMENTAZIONE EU</b> L.200 cm power cable EU w 2 lmt. 		150 690 (*)	1,5	0,001	1	€ 13,00						
								(*)				
							500	NERO		black		
							500	NERO		black		

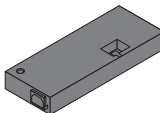
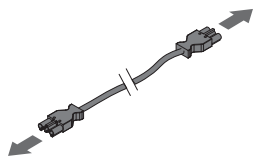

## CANALI PORTA-CAVI PER SCRIVANIE GAMBE A "T" (con sistema motorizzato)

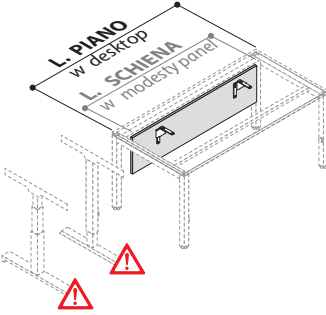
*cable trays for desks "T" legs (with automatic system)*

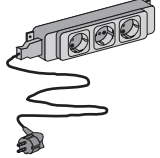
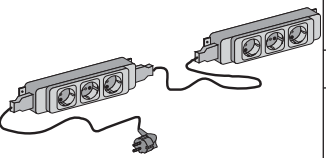
DESCRIZIONE <i>description</i>	L <i>w</i>	CODICE <i>code</i>	KG 	M <sup>3</sup> 	COLLI 	PREZZO <i>price</i>	(*) CODICE FINITURA <i>(*) finish code</i>
CANALI PORTA-CAVI CON SUPPORTI PER SCRIVANIE PROF. CM 80 <i>cable trays with support elements for desks deep 80 cms</i>    L. x p.15 x H.7	L.98	150 <b>801</b> (*)	4	0,024	1	€ 91,00	(*) 000 ARGENTO <i>silver</i> 400 BIANCO <i>white</i>
	L.140	150 <b>802</b> (*)	6	0,034	1	€ 98,00	
	PROSPETTO INFORMATIVO / <i>fact-sheet</i> CANALE PORTACAVI <i>cable tray</i>		UTILIZZABILE SU PIANI <i>usable on the desktops</i>		ART.801 L.120-140-160 ART.802 L.160-180		
	 <b>NON UTILIZZABILE IN PRESENZA DI SCHIENA</b> <i>DO NOT USE TOGETHER WITH THE MODESTY PANEL</i>						
CANALI PORTA-CAVI CON SUPPORTI PER SCRIVANIE PROF. CM 90 <i>cable trays with support elements for desks deep 90 cms</i>    L. x p.15 x H.7	L.98	150 <b>811</b> (*)	4	0,024	1	€ 89,00	(*) 000 ARGENTO <i>silver</i> 400 BIANCO <i>white</i>
	L.140	150 <b>812</b> (*)	6	0,034	1	€ 100,00	
	PROSPETTO INFORMATIVO / <i>fact-sheet</i> CANALE PORTACAVI <i>cable tray</i>		UTILIZZABILE SU PIANI <i>usable on the desktops</i>		ART.811 L.120-140-160 ART.812 L.160-180-200		
	 <b>NON UTILIZZABILE IN PRESENZA DI SCHIENA</b> <i>DO NOT USE TOGETHER WITH THE MODESTY PANEL</i>						
<b>ELEMENTI DI RICAMBIO PER SCRIVANIE GAMBE A "T" (con sistema motorizzato)</b> <i>spare parts for desks "T" legs (with automatic system)</i>							
SISTEMA DI CONTROLLO PER SCRIVANIA TELESCOPICA SINGOLA <i>control system for telescopic single desk</i>  		150 <b>685</b> (*)	2,5	0,004	1	€ 201,00	(*) 500 NERO <i>black</i>
CAVO PROLUNGA PER SCRIVANIE CON LUNGHEZZA > 200 <i>power cable extension for desk with width &gt; 200</i>  		150 <b>691</b> (*)	1,5	0,001	1	€ 18,00	(*) 500 NERO <i>black</i>

<b>SCHIENE (OPTIONAL)</b> <i>modesty panels (optional)</i>									
DESCRIZIONE <i>description</i>	L w	L w	CODICE <i>code</i>	KG 	M <sup>3</sup> 	COLLI 	PREZZO <i>price</i>	(*) CODICE FINITURA <i>(*) finish code</i>	
SCHIENE UTILIZZABILI SU TUTTE LE STRUTTURE "UP" <i>modesty panels for all structure "UP"</i>    L. x p.1,8 x H.30	<b>L. SCHIENA w modesty</b>		<b>UTILIZZARE SU PIANI use for desktops</b>						
	L.107	L.120	150 401 (*)	7	0,020	2	€ 35,00		
	L.127	L.140	150 402 (*)	8	0,023	2	€ 37,00		
	L.147	L.160	150 403 (*)	9	0,026	2	€ 40,00	(*)	
	L.167	L.180	150 404 (*)	10	0,029	2	€ 43,00	000	ARGENTO GOLF <i>golf silver</i>
	L.187	L.200	150 405 (*)	11	0,029	2	€ 54,00	400	BIANCO BR. <i>br. white</i>
 <b>SULLE SCRIVANIE CON STRUTTURE A "T" LE SCHIENE NON SONO UTILIZZABILI IN PRESENZA DI CANALE PORTA-CAVI ON DESKS WITH "T" METAL STRUCTURE DO NOT USE MODESTY PANEL TOGETHER WITH THE CABLE TRAY</b>									
<b>KIT PRESE (OPTIONAL)</b> <i>sockets kit (optional)</i>									
KIT ELETTRIFICAZIONE SINGOLO <b>CON PRESE SCHUKO</b> E CAVO DI ALIMENTAZIONE DI MT. 2,00 <i>single electrification kit with SCHUKO plugs and power cable w 2 lmt.</i>    <b>NON DISPONIBILE PER MERCATO U.S.A. not available for US market</b>			175 899 (*)	1	0,006	1	€ 86,00		
KIT ELETTRIFICAZIONE DOPPIO <b>CON PRESE SCHUKO</b> E CAVO DI ALIMENTAZIONE DI MT. 2,00 <i>double electrification kit with SCHUKO plugs and power cable w 2 lmt.</i>    <b>NON DISPONIBILE PER MERCATO U.S.A. not available for US market</b>			175 900 (*)	1	0,006	1	€ 160,00	(*)	
								500	NERO <i>black</i>
KIT PROLUNGA DI MT. 2,00 CON PRESA ENTRATA/1 USCITA <i>extension kit of w 2 lmt. with an input-and-out-put-plug</i>    <b>NON DISPONIBILE PER MERCATO U.S.A. not available for US market</b>			175 901 (*)	0,5	0,002	1	€ 30,00		

**DESCRIZIONE TECNICA mod. UP****SCRIVANIE GAMBE A PONTE CON ALTEZZA REGOLABILE H.65+85 (CON POMO O MANOVELLA):**

Costituito da : un piano scrivania, due gambe a ponte, una trave portante e una trave supplementare (optional su L.120 e L.140)

**Piani di lavoro** realizzati con pannello di particelle di legno sp. mm 25 nobilitato in melaminico (Classe E1 basso contenuto di Formaldeide ) e bordato perimetralmente in ABS mm 2 in tinta con la superficie e disponibili nei colori: ROVERE 03, ROVERE GREY 04, NOCE PAVIA 06, GRIGIO 42, STONE GREY 44, WENG' 45, ACERO TAKI 58, BIANCO BR. 69.

**Gambe a ponte** sono realizzate con tubolari metallici telescopici a sezione quadrata mm 50x50x2, verniciati a polveri epossidiche nei colori: ARGENTO e BIANCO.

Alla base delle gambe sono situati piedini livellatori. Nella parte trasversale superiore sono situati attacchi per il fissaggio della trave portante e della supplementare.

**La regolazione in altezza avviene mediante sistema a pomo o a manovella.** La scala graduata stampata indica le dimensioni in altezza della scrivania compreso il piano.

**Trave portante** realizzata in tubolare metallico a sezione quadrata mm 50x50x2, verniciata a polveri epossidiche nei colori: ARGENTO e BIANCO. Presenta delle asole per l'aggancio del canale passa-cavi.

**Trave supplementare** realizzata in tubolare metallico a sezione rettangolare mm 45x25x2, verniciata a polveri epossidiche nei colori: ARGENTO e BIANCO.

**CANALI PORTA CAVI PER SCRIVANIE CON GAMBE A PONTE:**

Realizzati in lamiera metallica sp. mm 1 verniciata a polveri epossidiche nel colore ARGENTO e BIANCO, consente l'alloggiamento di kit elettrificazione e la raccolta di cavi in eccesso. Il montaggio avviene a sospensione sulla trave portante , lato visitatore, delle scrivanie con gambe a ponte.

**SCRIVANIE GAMBE A "T" CON ALTEZZA REGOLABILE H.65+85 (CON POMO O MANOVELLA):**

Costituito da : un piano scrivania, due gambe a "T", una trave portante centrale.

**Piani di lavoro** sono realizzati con pannelli di particelle di legno sp. mm 25 nobilitati in melaminico (Classe E1 basso contenuto di Formaldeide ) e bordati perimetralmente in ABS mm 2 in tinta con la superficie e disponibili nei colori: ROVERE 03, ROVERE GREY 04, NOCE PAVIA 06, GRIGIO 42, STONE GREY 44, WENG' 45, ACERO TAKI 58, BIANCO BR. 69.

**Le gambe a "T"** sono realizzate con tubolari metallici telescopici a sezione rettangolare mm 75x55x2 idonei al fissaggio della trave centrale, verniciati a polveri epossidiche nei colori: ARGENTO e BIANCO. Alla base delle gambe sono situati piedini livellatori.

**La regolazione in altezza avviene mediante sistema a pomo o a manovella.** La scala graduata indica le dimensioni in altezza della scrivania compreso il piano.

**Trave portante** realizzata in tubolare metallico a sezione quadrata mm 50x50x2, verniciata a polveri epossidiche nei colori: ARGENTO e BIANCO. Dotata di 4 traverse per l'aggancio del canale passa-cavi e per l'inserimento del sistema a manovella.

**BENCH GAMBE A PONTE CON ALTEZZA REGOLABILE H.65+85 (CON MANOVELLA):**

Costituito da : due piani scrivania, due gambe a ponte, due travi portanti centrali.

**Piani di lavoro** sono realizzati con pannelli di particelle di legno sp. mm 25 nobilitati in melaminico (Classe E1 basso contenuto di Formaldeide ) e bordati perimetralmente in ABS mm 2 in tinta con la superficie e disponibili nei colori: ROVERE 03, ROVERE GREY 04, NOCE PAVIA 06, GRIGIO 42, STONE GREY 44, WENG' 45, ACERO TAKI 58, BIANCO BR. 69.

**Gambe a ponte** sono realizzate con tubolari metallici telescopici a sezione rettangolare mm 65x50x2, verniciati a polveri epossidiche nei colori: ARGENTO e BIANCO.

Alla base delle gambe sono situati piedini livellatori. Nella parte trasversale superiore sono situati attacchi per il fissaggio delle travi portanti centrali e dell'eventuale pannello frontale.

**Travi portanti** realizzate in tubolare metallico a sezione quadrata mm 50x50x2, verniciate a polveri epossidiche nei colori: ARGENTO e BIANCO. Dotate ognuna di 4 traverse per l'aggancio del canale passa-cavi e per l'inserimento del sistema a manovella.

**PANNELLI FRONTALI PER BENCH:**

Disponibili nelle lunghezze L.160-180

Sono realizzati con pannelli di particelle di legno totale spessore mm 40, rivestiti in Tessuto Poliестere Stretch, disponibili nei colori: AZZURRO SKY 320, GIALLO FRESIA 321, AMARANTO 322, VERDE BOSCO 323, GRIGIO 327, TORTORA 328, MATTONE 330, ARANCIO 331, ROSSO 332, VERDE ACIDO 333, BLU 334. Perimetralmente sono rifiniti con profilo metallico verniciato ARGENTO e BIANCO. Sulla parte superiore è inserito un binario di alluminio estruso per l'aggancio di accessori sospesi.

Il montaggio dei pannelli frontali avviene sopra le gambe a ponte del bench con le staffe in dotazione.

**CANALI PORTA CAVI PER SCRIVANIE CON GAMBE A "T" O BENCH:**

Realizzati in lamiera metallica sp. mm 1 verniciata a polveri epossidiche nel colore ARGENTO e BIANCO, consente l'alloggiamento di kit elettrificazione e la raccolta di cavi in eccesso. Il montaggio avviene a sospensione sull'estremità delle traverse della trave portante centrale.

**SCRIVANIE GAMBE A "T" CON ALTEZZA REGOLABILE H.62+128 (CON SISTEMA MOTORIZZATO):**

Costituito da : un piano scrivania, due gambe a "T" motorizzate, un telaio sottopiano con 2 travi portanti, una centralina elettrica.

**Piani di lavoro** sono realizzati con pannelli di particelle di legno sp. mm 25 nobilitati in melaminico (Classe E1 basso contenuto di Formaldeide ) e bordati perimetralmente in ABS mm 2 in tinta con la superficie e disponibili nei colori: ROVERE 03, ROVERE GREY 04, NOCE PAVIA 06, GRIGIO 42, STONE GREY 44, WENG' 45, ACERO TAKI 58, BIANCO BR. 69.

**Le gambe a "T"** sono realizzate con tubolari metallici telescopici a sezione rettangolare mm 70x70x2, verniciati a polveri epossidiche nei colori: ARGENTO e BIANCO. Alla base delle gambe sono situati piedini livellatori.

**La regolazione in altezza avviene mediante sistema motorizzato.** La scala graduata indica le dimensioni in altezza della scrivania compreso il piano.

Telaio sottopiano con due travi portanti realizzate in tubolare metallico a sezione quadrata mm 50x25x2, verniciate a polveri epossidiche nei colori: ARGENTO e BIANCO. Dotate di fori per il fissaggio dei supporti idonei a sostenere i canali-portacavi.

**Le scrivanie motorizzate devono essere sempre completate con pulsantiera e cavo di alimentazione!**

**SCIENIE PER SCRIVANIE:**

Realizzate in pannelli di particelle di legno sp. mm 18 nobilitati in melaminico (Classe E1 basso contenuto di Formaldeide) e bordati perimetralmente in ABS mm 2 in tinta con la superficie e disponibili nei colori: ARGENTO GOLF 01 e BIANCO BR. 69.

Si fissano sulla parte inferiore del lato frontale dei piani di lavoro mediante staffe metalliche colore ARGENTO .

CARATTERISTICHE FISICO-MECCANICHE DEI PANNELLI DI PARTICELLE DI LEGNO DI SPESSORE mm 18 NOBILITATI IN MELAMINICO:		
DESCRIZIONE	VALORE MINIMO	NORMA DI RIFERIMENTO
Massa volumica	650 Kg / m <sup>3</sup> ± 10%	UNI EN 323 :1994
Umidità relativa	5 - 13%	UNI EN 322 :1994
Tolleranza spessore	± 0,3 mm	UNI EN 324-1/1994
Rigonfiamento a 24 ore	15%	UNI EN 317 :1994
Distacco strati esterni	0,8 Mpa	UNI EN 311 :2003
Flessione statica	16 Mpa	UNI EN 310 :1994
Modulo di elasticità	1600 Mpa	UNI EN 310 :1994
Estrazione viti sui bordi	> 400 N	UNI EN 320 :1994
Contenuto di formaldeide	≤ a 3,5 mg H <sub>2</sub> CO (m <sup>2</sup> x h)	UNI EN ISO 12460 - 3:2015

Emesso da Ufficio Tecnico LAS MOBILI  
Data ultima revisione: GENNAIO 2018

## TECHNICAL DESCRIPTION mod. UP

UP

### DESKS BRIDGE LEGS WITH ADJUSTABLE HEIGHT H 65÷85 cms (WITH KNOB OR CRANK)

It is composed of : a worktop, two bridge legs, a supporting beam and an additional beam (optional for w.120 and w.140)

**Worktop** made of particleboard panels 25mm thick. (Class E1 low formaldehyde content) , melamine-faced in the following colours: OAK 03, GREY OAK 04, PAVIA WALNUT 06, GREY 42, STONE GREY 44, WENGE' 45, TAKI MAPLE 58, BR. WHITE 69. Edge-finishing in 2 mm ABS matching the main shade.

**Bridge legs** made of telescopic metallic tubular with squared section mm 50x50x2, painted with epoxy resin powder in SILVER and WHITE colour.

In the lower position there are adjustable feet. In the upper and transverse part are situated connections for fixing the supporting beams.

**The height is adjusted by a knob or crank system.** The scale printed indicates the size in height of the desk including the worktop.

**Supporting beam** made of metallic tubular with squared section mm 50x50x2, painted with epoxy resin powder in SILVER and WHITE colours. It has holes for attachment of the cable tray.

**Additional beam** made of metallic tubular with rectangular section mm 45x25x2, painted with epoxy resin powder in SILVER and WHITE colours.

### CABLE TRAY FOR DESKS WITH BRIDGE LEGS:

Made of metallic sheet thick 1 mm , painted with epoxy resin powder in SILVER or WHITE colours, allows the insertion of electrification kit and the support of excess cables. Hook on the external beam (guest side).

### DESKS "T" LEGS WITH ADJUSTABLE HEIGHT H 65÷85 cms (WITH KNOB OR CRANK)

It is composed of : a worktop, two "T" legs, a support central beam.

**Worktop** made of particleboard panels 25mm thick. (Class E1 low formaldehyde content) , melamine-faced in the following colours: OAK 03, GREY OAK 04, PAVIA WALNUT 06, GREY 42, STONE GREY 44, WENGE' 45, TAKI MAPLE 58, BR. WHITE 69. Edge-finishing in 2 mm ABS matching the main shade.

**The "T" legs** are made of telescopic metallic tubulars with rectangular section mm 75x55x2 for fixing of central beam, painted with epoxy resin powder in SILVER and WHITE colours. In the lower position there are adjustable feet.

**The height is adjusted by a knob or crank system.** The scale printed indicates the size in height of the desk including the worktop.

**Supporting beam** made of metallic tubular with squared section mm 50x50x2, painted with epoxy resin powder in SILVER and WHITE colours.

There are 4 crossbars for hooking of the cable tray and for the insertion of the crank system.

### BENCH BRIDGE LEGS WITH ADJUSTABLE HEIGHT H 65÷85 cms (WITH CRANK):

It is composed of : two worktops, two bridge legs, two central support beams.

**Worktop** made of particleboard panels 25mm thick. (Class E1 low formaldehyde content) , melamine-faced in the following colours: OAK 03, GREY OAK 04, PAVIA WALNUT 06, GREY 42, STONE GREY 44, WENGE' 45, TAKI MAPLE 58, BR. WHITE 69. Edge-finishing in 2 mm ABS matching the main shade.

**Bridge legs** made of telescopic metallic tubular with rectangular section mm 65x50x2, painted with epoxy resin powder in SILVER and WHITE colours.

In the upper and transverse part are situated connections for fixing the central supporting beams and eventual front panel.

**Supporting beams** made of metallic tubular with squared section mm 50x50x2, painted with epoxy resin powder in SILVER and WHITE colours.

In each beam there are 4 crossbars for hooking of the cable tray and for the insertion of the crank system.

### FRONT PANEL FOR BENCH:

Available in the width 160-180 cms.

Are made of particleboard panels, 40mm total thickness, covered with Fire-retardant Stretch Polyester Fabric, available in the following colours: SKY BLUE 320, FREESIA YELLOW 321, AMARANTH 322, WOOD GREEN 323, GREY 327, GREY BEIGE 328, BRIK RED 330, ORANGE 331, RED 332, ACID GREEN 333, BLUE 334. Perimetrically finished with metal profile painted in SILVER and WHITE colours. In the upper side is inserted an aluminium rail for hooking of the suspended accessories.

The assembly of the front panel is above the bridge legs of the bench with the supplied brackets

### CABLE TRAYS FOR DESKS WITH "T" LEGS OR BENCH:

Made of metallic sheet thick 1 mm , painted with epoxy resin powder in SILVER or WHITE colour, allows the insertion of electrification kit and the support of excess cables.

The trays are suspended on the end of the crossbars of the central supporting beam.

### DESKS "T" LEGS WITH ADJUSTABLE HEIGHT H.62÷128 cms (WITH AUTOMATIC SYSTEM):

It is composed of : a worktop, two automatic "T" legs, an undertop frame with two supporting beams, a control system box.

**Worktop** made of particleboard panels 25mm thick. (Class E1 low formaldehyde content) , melamine-faced in the following colours: OAK 03, GREY OAK 04, PAVIA WALNUT 06, GREY 42, STONE GREY 44, WENGE' 45, TAKI MAPLE 58, BR. WHITE 69. Edge-finishing in 2 mm ABS matching the main shade.

**"T" Legs** are made of telescopic metallic tubulars with rectangular section mm 70x70x2, painted with epoxy resin powder in SILVER or WHITE colours. In the lower position there are adjustable feet.

**The height is adjusted by an automatic system.** The scale printed indicates the size in height of the desk including the worktop.

Undertop frame with two supporting beams made of metallic tubulars with squared section mm 50x25x2, painted with epoxy resin powder in SILVER or WHITE colours.

In the beams there are holes for fixing of the supports for cable trays.

**The automatic desks must always be completed with control panel up/down and power cable!**

### MODESTY PANEL FOR DESKS:

Made of particleboard panels 18mm thick. (Class E1 low formaldehyde content) , melamine-faced in the following colours: GOLF SILVER 01 and BR. WHITE 69. Edge-finishing in 2 mm ABS matching the main shade.

They are secured to the lower part of the front side of the worktops using SILVER-coloured metal brackets.

PHYSICAL-MECHANICAL CHARACTERISTICS OF 18 MM THICK PARTICLEBOARD PANELS, MELAMINE-FACED:		
DESCRIPTION	MINIMUM VALUE	STANDARD NUMBERS
Volume Mass	650 Kg / m <sup>3</sup> ± 10%	UNI EN 323 :1994
Relative Humidity	5 - 13%	UNI EN 322 :1994
Thickness Allowance	± 0,3 mm	UNI EN 324-1/1994
24 hour Swelling	15%	UNI EN 317 :1994
External Surfaces Detachment	0,8 Mpa	UNI EN 311 :2003
Static Flexure	16 Mpa	UNI EN 310 :1994
Elastic Modulus	1600 Mpa	UNI EN 310 :1994
Edge Screws Extraction	> 400 N	UNI EN 320 :1994
Formaldehyde Content	≤ a 3,5 mg H <sub>2</sub> CO (m <sup>2</sup> x h)	UNI EN ISO 12460 - 3:2015

Released by the Technical Office of LAS MOBILI  
last revision date: JANUARY 2018



# INDICE DEI CODICI

codes index

\* = INDICARE IL CODICE FINITURA  
= complete with finish code

INDICE DEI CODICI / codes index  
Mod. UP

CODICE code	DESCRIZIONE description	SP. PIANO top thick.	PAG. page	PREZZO price
150 018 *	SCRIVANIA GAMBE A PONTE CON ALTEZZA REGOLABILE L.120 x p.80 desk bridge legs with adjustable height w 120 x d 80 cms	CON POMO with knob	25 mm	8 € 484,00
150 019 *	SCRIVANIA GAMBE A PONTE CON ALTEZZA REGOLABILE L.140 x p.80 desk bridge legs with adjustable height w 140 x d 80 cms	CON POMO with knob	25 mm	8 € 500,00
150 020 *	SCRIVANIA GAMBE A PONTE CON ALTEZZA REGOLABILE L.160 x p.80 desk bridge legs with adjustable height w 160 x d 80 cms	CON POMO with knob	25 mm	8 € 542,00
150 021 *	SCRIVANIA GAMBE A PONTE CON ALTEZZA REGOLABILE L.180 x p.80 desk bridge legs with adjustable height w 180 x d 80 cms	CON POMO with knob	25 mm	8 € 560,00
150 080 *	SCRIVANIA GAMBE A PONTE CON ALTEZZA REGOLABILE L.120 x p.80 desk bridge legs with adjustable height w 120 x d 80 cms	CON MANOVELLA with crank	25 mm	8 € 936,00
150 081 *	SCRIVANIA GAMBE A PONTE CON ALTEZZA REGOLABILE L.140 x p.80 desk bridge legs with adjustable height w 140 x d 80 cms	CON MANOVELLA with crank	25 mm	8 € 953,00
150 082 *	SCRIVANIA GAMBE A PONTE CON ALTEZZA REGOLABILE L.160 x p.80 desk bridge legs with adjustable height w 160 x d 80 cms	CON MANOVELLA with crank	25 mm	8 € 1.001,00
150 083 *	SCRIVANIA GAMBE A PONTE CON ALTEZZA REGOLABILE L.180 x p.80 desk bridge legs with adjustable height w 180 x d 80 cms	CON MANOVELLA with crank	25 mm	8 € 1.020,00
150 115 *	TRAVE SUPPLEMENTARE PER SCRIVANIE CON GAMBE A PONTE L.120 additional beam for desks with bridge legs w 120 cms		8	€ 29,00
150 116 *	TRAVE SUPPLEMENTARE PER SCRIVANIE CON GAMBE A PONTE L.140 additional beam for desks with bridge legs w 140 cms		8	€ 31,00
150 120 *	CANALE PORTA-CAVI BASCULANTE PER SCRIVANIE CON GAMBE A PONTE L.120+1 FISSAGGIO CAVI + 2 CLIP FERMACAVI tilting cable tray for desks with bridge legs w 120 cms + 1 fixing cable + 2 plastic cable clamp		8	€ 48,00
150 121 *	CANALE PORTA-CAVI BASCULANTE PER SCRIVANIE CON GAMBE A PONTE L.140+1 FISSAGGIO CAVI + 2 CLIP FERMACAVI tilting cable tray for desks with bridge legs w 140 cms + 1 fixing cable + 2 plastic cable clamp		8	€ 52,00
150 122 *	CANALE PORTA-CAVI BASCULANTE PER SCRIVANIE CON GAMBE A PONTE L.160+1 FISSAGGIO CAVI + 2 CLIP FERMACAVI tilting cable tray for desks with bridge legs w 160 cms + 1 fixing cable + 2 plastic cable clamp		8	€ 59,00
150 123 *	CANALE PORTA-CAVI BASCULANTE PER SCRIVANIE CON GAMBE A PONTE L.180+1 FISSAGGIO CAVI + 2 CLIP FERMACAVI tilting cable tray for desks with bridge legs w 180 cms + 1 fixing cable + 2 plastic cable clamp		8	€ 65,00
150 318 *	SCRIVANIA GAMBE A "T" CON ALTEZZA REGOLABILE L.120 x p.80 desk "T" legs with adjustable height w 120 x d 80 cms	CON POMO with knob	25 mm	9 € 502,00
150 319 *	SCRIVANIA GAMBE A "T" CON ALTEZZA REGOLABILE L.140 x p.80 desk "T" legs with adjustable height w 140 x d 80 cms	CON POMO with knob	25 mm	9 € 512,00
150 320 *	SCRIVANIA GAMBE A "T" CON ALTEZZA REGOLABILE L.160 x p.80 desk "T" legs with adjustable height w 160 x d 80 cms	CON POMO with knob	25 mm	9 € 526,00
150 321 *	SCRIVANIA GAMBE A "T" CON ALTEZZA REGOLABILE L.180 x p.80 desk "T" legs with adjustable height w 180 x d 80 cms	CON POMO with knob	25 mm	9 € 546,00
150 380 *	SCRIVANIA GAMBE A "T" CON ALTEZZA REGOLABILE L.120 x p.80 desk "T" legs with adjustable height w 120 x d 80 cms	CON MANOVELLA with crank	25 mm	9 € 769,00
150 381 *	SCRIVANIA GAMBE A "T" CON ALTEZZA REGOLABILE L.140 x p.80 desk "T" legs with adjustable height w 140 x d 80 cms	CON MANOVELLA with crank	25 mm	9 € 782,00
150 382 *	SCRIVANIA GAMBE A "T" CON ALTEZZA REGOLABILE L.160 x p.80 desk "T" legs with adjustable height w 160 x d 80 cms	CON MANOVELLA with crank	25 mm	9 € 797,00
150 383 *	SCRIVANIA GAMBE A "T" CON ALTEZZA REGOLABILE L.180 x p.80 desk "T" legs with adjustable height w 180 x d 80 cms	CON MANOVELLA with crank	25 mm	9 € 820,00
150 398 *	BENCH L.160 bench w 160 cms	CON MANOVELLA with crank	25 mm	9 € 1.584,00
150 399 *	BENCH L.180 bench w 180 cms	CON MANOVELLA with crank	25 mm	9 € 1.630,00
150 401 *	SCHIENA PER SCRIVANIA L.120 modesty panel for desk w 120 cms		12	€ 35,00
150 402 *	SCHIENA PER SCRIVANIA L.140 modesty panel for desk w 140 cms		12	€ 37,00
150 403 *	SCHIENA PER SCRIVANIA L.160 modesty panel for desk w 160 cms		12	€ 40,00
150 404 *	SCHIENA PER SCRIVANIA L.180 modesty panel for desk w 180 cms		12	€ 43,00
150 405 *	SCHIENA PER SCRIVANIA L.200 modesty panel for desk w 200 cms		12	€ 54,00
150 408 *	PANNELLO FRONTALE PER BENCH L.160 front panel for bench w 160 cms	PROFILO E STAFFE COLORE: ARGENTO edge profile and stirrups colour: silver	40 mm	9 € 524,00
150 409 *	PANNELLO FRONTALE PER BENCH L.180 front panel for bench w 180 cms	PROFILO E STAFFE COLORE: ARGENTO edge profile and stirrups colour: silver	40 mm	9 € 585,00
150 411 *	PANNELLO FRONTALE PER BENCH L.160 front panel for bench w 160 cms	PROFILO E STAFFE COLORE: BIANCO edge profile and stirrups colour: white	40 mm	9 € 524,00
150 412 *	PANNELLO FRONTALE PER BENCH L.180 front panel for bench w 180 cms	PROFILO E STAFFE COLORE: BIANCO edge profile and stirrups colour: white	40 mm	9 € 585,00
150 420 *	CANALE PORTA-CAVI PER SCRIVANIA GAMBE A "T" CON ALTEZZA REGOLABILE L.120 cable tray for desk "T" legs with adjustable height w 120 cms		9	€ 68,00
150 421 *	CANALE PORTA-CAVI PER SCRIVANIA GAMBE A "T" CON ALTEZZA REGOLABILE L.140 cable tray for desk "T" legs with adjustable height w 140 cms		9	€ 77,00
150 422 *	CANALE PORTA-CAVI PER SCRIVANIA GAMBE A "T" CON ALTEZZA REGOLABILE L.160 o BENCH cable tray for desk "T" legs with adjustable height w 160 cms or bench		9	€ 82,00
150 423 *	CANALE PORTA-CAVI PER SCRIVANIA GAMBE A "T" CON ALTEZZA REGOLABILE L.180 o BENCH cable tray for desk "T" legs with adjustable height w 180 cms or bench		9	€ 95,00
150 618 *	SCRIVANIA GAMBE A "T" CON ALTEZZA REGOLABILE L.120 x p.80 desk "T" legs with adjustable height w 120 x d 80 cms	CON SISTEMA MOTORIZZATO with automatic system	25 mm	10 € 1.393,00
150 619 *	SCRIVANIA GAMBE A "T" CON ALTEZZA REGOLABILE L.140 x p.80 desk "T" legs with adjustable height w 140 x d 80 cms	CON SISTEMA MOTORIZZATO with automatic system	25 mm	10 € 1.408,00
150 620 *	SCRIVANIA GAMBE A "T" CON ALTEZZA REGOLABILE L.160 x p.80 desk "T" legs with adjustable height w 160 x d 80 cms	CON SISTEMA MOTORIZZATO with automatic system	25 mm	10 € 1.423,00
150 621 *	SCRIVANIA GAMBE A "T" CON ALTEZZA REGOLABILE L.180 x p.80 desk "T" legs with adjustable height w 180 x d 80 cms	CON SISTEMA MOTORIZZATO with automatic system	25 mm	10 € 1.443,00
150 638 *	SCRIVANIA SAGOMATA GAMBE A "T" CON ALTEZZA REGOLABILE L.160 x p.90 shaped desk "T" legs with adjustable height w 160 x d 90 cms	CON SISTEMA MOTORIZZATO with automatic system	25 mm	10 € 1.459,00
150 639 *	SCRIVANIA GAMBE A "T" CON ALTEZZA REGOLABILE L.180 x p.90 desk "T" legs with adjustable height w 180 x d 90 cms	CON SISTEMA MOTORIZZATO with automatic system	25 mm	10 € 1.454,00
150 640 *	SCRIVANIA GAMBE A "T" CON ALTEZZA REGOLABILE L.200 x p.90 desk "T" legs with adjustable height w 200 x d 90 cms	CON SISTEMA MOTORIZZATO with automatic system	25 mm	10 € 1.468,00
150 680 *	PULSANTIERA UP/DOWN control panel UP/DOWN		10	€ 22,00
150 681 *	PULSANTIERA UP/DOWN "COMFORT" control panel UP/DOWN "COMFORT"		10	€ 95,00
150 685 *	SISTEMA DI CONTROLLO PER SCRIVANIE TELESCOPICA SINGOLA control system for telescopic single desk	PER SISTEMA MOTORIZZATO for automatic system	11	€ 201,00
150 690 *	CAVO DI ALIMENTAZIONE EU power cable EU		10	€ 13,00
150 691 *	CAVO PROLLUNGA PER SCRIVANIE CON LUNGHEZZA > 200 CM power cable extension for desks with width > 200 cms	PER SISTEMA MOTORIZZATO for automatic system	11	€ 18,00
150 801 *	CANALE PORTA-CAVI + SUPPORTI PER SCRIVANIE PROF.80 cable tra'y + support elements for desks deep 80 cms	PER SISTEMA MOTORIZZATO for automatic system	11	€ 91,00
150 802 *	CANALE PORTA-CAVI + SUPPORTI PER SCRIVANIE PROF.80 cable tra'y + support elements for desks deep 80 cms	PER SISTEMA MOTORIZZATO for automatic system	11	€ 98,00
150 811 *	CANALE PORTA-CAVI + SUPPORTI PER SCRIVANIE PROF.90 cable tra'y + support elements for desks deep 90 cms	PER SISTEMA MOTORIZZATO for automatic system	11	€ 89,00
150 812 *	CANALE PORTA-CAVI + SUPPORTI PER SCRIVANIE PROF.90 cable tra'y + support elements for desks deep 90 cms	PER SISTEMA MOTORIZZATO for automatic system	11	€ 100,00
<b>OYO</b>				
175 899 *	KIT ELETRIF. SINGOLO CON PRESE SCHUKO E CAVO DI ALIMENTAZIONE DI MT 2,00 single electrification kit with SCHUKO sockets and power cable of w 200 cms		12	€ 86,00
175 900 *	KIT ELETRIF. DOPPIO CON PRESE SCHUKO E CAVO DI ALIMENTAZIONE DI MT 2,00 double electrification kit with SCHUKO sockets and power cable of w 200 cms		12	€ 160,00
175 901 *	KIT PROLLUNGA DI MT 2,00 CON 1 PRESA ENTRATA / 1 USCITA extension kit of w 200 cms with an input-and-out-put-plug		12	€ 30,00

UP





LISTINO 2018  
PRICE LIST

LOGIC

# LOGIC

Design  
CLAUDIO BELLINI

Engineering  
C.S.R. LAS MOBILI

Conforme al DLGS 81/2008 (già 626/'94)  
apply to RULE 81/2008 (626/'94)

## IMPORTANTE / it's very important



Certificato 04/16

SULL'ORDINE INDICARE SEMPRE IL CODICE COMPLETO A 9 CIFRE  
always indicate on the order the complete 9-digit code

ESEMPIO: PER ORDINARE 1 PIANO **ART.453** BIANCO BR. INDICARE IL CODICE =  
example: to order 1 DESKTOP **ART.453** BR. WHITE indicate the code =

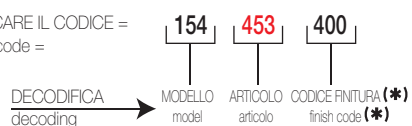

In vigore dal:  
Valid from:  
01/01/2018

Valido fino a nuova emissione  
Valid until new emission

<b>CERTIFICAZIONI DISPONIBILI / available certifications</b>			
<b>MATERIALI E FINITURE / materials and finishes</b>			
	<b>NORMA DI RIFERIMENTO standard norms</b>	<b>DESCRIZIONE NORMA</b>	<b>norm descriptions</b>
<b>ELEMENTI METALLICI / metallic elements</b>	Conformità DM 03/09/2001	Reazione al fuoco. Dichiarazione di conformità al DM 26/06/1984 modificato da DM 03/09/2001.	Reaction to fire. Declaration of conformity to the MD 26/06/1984 modified by MD 03/09/2001.
	UNI EN 13721:2004	Riflettanza della superficie.	Reflection factor of the surface.
	UNI EN 13722:2004	Riflessione speculare della superficie.	Measurement of specular gloss of the surface.
	UNI EN ISO 12460-3:2015	Rilascio di formaldeide. Gas analisi, prova singola.	Formaldehyde release.
	UNI 10460:1995	Determinazione della resistenza dei bordi all'acqua.	Water resistance of the edges.
	UNI 9242:1987 + UNI 9242:1987/A1/98	Determinazione della resistenza dei bordi al calore.	Determination of heat resistance of the edges.
	UNI EN 15187:2007	Valutazione degli effetti dell'esposizione alla luce.	Evaluation of the effects of the exposure to the light.
	ASTM D 3363:2005	Prova di durezza molla e/o matita.	Hardness test to pencil.
	EN ISO 1520:1995	Imbutitura statica.	Static drawing test.
	UNI 8901:1986	Resistenza all'urto.	Impact resistance.
	UNI 9115:1987	Comportamento delle superfici all'usura per abrasione. Abrasione Taber.	Taber abrasion. Test for abrasion resistance of the surfaces.
	UNI 9427:1989	Determinazione della resistenza delle superfici alla luce.	Test for light resistance of the surfaces.
	UNI 9428:1989	Prove sulle finiture delle superfici. Determinazione della resistenza alla graffiatura.	Test for scratch resistance of the surfaces.
	UNI 9429:1989	Determinazione della resistenza delle superfici agli sbalzi di temperatura.	Test for thermal endurance.
	UNI EN ISO 2409:1996	Adesione mediante quadrettatura.	Adhesion with checkering.
	UNI EN ISO 2808:2007	Pitture e vernici. Determinazione dello spessore del film.	Paints and varnishes. Determination of the film thickness.
	UNI EN ISO 9227:2006	Prove in nebbia salina.	Test for salt fog resistance.
<b>SCRIVANIE, WORKSTATION E TAVOLI / desks, workstation and tables</b>			
	<b>NORMA DI RIFERIMENTO standard norms</b>	<b>DESCRIZIONE NORMA</b>	<b>norm descriptions</b>
	Conformità D.LGS. 09/04/2008 nr.81	Dichiarazione di Conformità al D.LGS. 09/04/2008 nr.81 (ex 626).	Declaration of conformity to the Italian rule D.LGS. 09/04/2008 nr.81 (ex 626).
	UNI 8594:2004	Prova di flessione dei piani.	Test for flexural strength of the tops.
	UNI 9086:1987	Prova di urto contro le gambe o i fianchi di sostegno.	Impact test against the legs or the support side panels.
	UNI EN 527-1:2000	Dimensioni.	Dimensions.
	UNI EN 527-2:2003 Par. 3	Par. 3 Requisiti meccanici di sicurezza. Requisiti generali di progettazione.	Par. 3 Safety mechanics requirements. General requirements of the engineering
	UNI EN 527-3:2003 Par. 5.1	Par. 5.1 Stabilità.	Par. 5.1 Stability.
	UNI EN 527-3:2003 Par. 5.2	Par. 5.2 Resistenza sotto una forza verticale.	Par. 5.2 Resistance to vertical force.
	UNI EN 527-3:2003 Par. 5.3	Par. 5.3 Resistenza sotto una forza orizzontale.	Par. 5.3 Resistance to horizontal force.
	UNI EN 527-3:2003 Par. 5.4	Par. 5.4 Fatica sotto una forza orizzontale.	Par. 5.4 Endurance limit to horizontal force.
	UNI EN 527-3:2003 Par. 5.5	Par. 5.5 Fatica sotto una forza verticale.	Par. 5.5 Endurance limit to vertical force.
	UNI EN 527-3:2003 Par. 5.6	Par. 5.6 Prova di caduta.	Par. 5.6 Drop test.

ULTIMA REVISIONE: GENNAIO 2018  
latest revision: JANUARY 2018

Per eventuali aggiornamenti più recenti  
le **CERTIFICAZIONI** e i **LISTINI** sono disponibili su Internet:  
For latest updates  
the **CERTIFICATIONS** and **PRICE LIST** are available on Internet:

- 1-  [www.las.it](http://www.las.it)
- 2- AREA RISERVATA RIVENDITORE  
Dealer's private area
- 3- SCARICA DOCUMENTI IN FORMATO .PDF  
Downloads .PDF files



<b>CARTELLA COLORI</b> .....	<b>6</b>
<i>colours samples card</i>	
<b>DETTAGLIO DIMENSIONI SCRIVANIE</b> .....	<b>7</b>
<i>details of desks dimensions</i>	
<b>TABELLE DIMENSIONI SCRIVANIE CON I DIVERSI BASAMENTI DI SUPPORTO</b> .....	<b>8</b>
<i>information sheet for dimensions of desks with support basements</i>	
<b>PIANI SCRIVANIE LINEARI E PIANI WORKSTATION (travi di sostegno incluse)</b> .....	<b>10</b>
<i>linear desk tops and workstation tops (support beams included)</i>	
<b>SCHEMA BASAMENTI UTILIZZABILI A LIVELLO DEL PIANO DI LAVORO</b> .....	<b>11</b>
<i>support elements fact-sheet</i>	
<b>FIANCHI LEGNO PER SCRIVANIE</b> .....	<b>12</b>
<i>wooden side panels for desks</i>	
<b>GAMBE METALLICHE PER SCRIVANIE</b> .....	<b>12</b>
<i>metallic legs for single desks</i>	
<b>ALLUNGO PER SCRIVANIE SINGOLE PROF. CM 80</b> .....	<b>13</b>
<i>extension for single desks deep 80 cms</i>	
<b>PORTA-CPU PER SCRIVANIE SINGOLE O CONDIVISE</b> .....	<b>13</b>
<i>CPU-holder for single or sharing desks</i>	
<b>MOBILI PORTANTI PER SCRIVANIE SINGOLE</b> .....	<b>14</b>
<i>support cabinets for single desks</i>	
<b>CASSETTIERE SU RUOTE</b> .....	<b>15</b>
<i>pedestal on wheels</i>	
<b>PIANI WORKSTATION PER STORAGE (travi incluse)</b> .....	<b>15</b>
<i>workstation tops for storage (support beams included)</i>	
<b>ACCESSORI PER STORAGE</b> .....	<b>17</b>
<i>accessories for storage</i>	
<b>SCHEMA BASE PER UTILIZZO PIANI AGGREGATI CON STORAGE</b> .....	<b>18</b>
<i>top for storage fact-sheet</i>	
<b>ESEMPI DI AGGREGAZIONE SCRIVANIE CON STORAGE ART.578</b> .....	<b>20</b>
<i>assembling desks with storage art.578 examples</i>	
<b>ESEMPI DI AGGREGAZIONE SCRIVANIE CON STORAGE ART.584</b> .....	<b>21</b>
<i>assembling desks with storage art.584 examples</i>	
<b>ESEMPI DI AGGREGAZIONE SCRIVANIE CON STORAGE ART.584</b> .....	<b>22</b>
<i>assembling desks with storage art.584 examples</i>	
<b>PANNELLI FRONTALI E SCHERMI LATERALI IN METACRILATO</b> .....	<b>23</b>
<i>front panels and methacrylate side screens</i>	
<b>ACCESSORI AGGANCIABILI SU PANNELLI FRONTALI</b> .....	<b>24</b>
<i>accessories fixed to front panels</i>	
<b>ACCESSORI DA APPOGGIARE</b> .....	<b>24</b>
<i>freestanding accessories</i>	
<b>VASCHETTE PASSA-CAVI</b> .....	<b>24</b>
<i>plate cable channels</i>	
<b>MODESTY PANELS</b> .....	<b>25</b>
<i>modesty panels</i>	
<b>TAVOLI RIUNIONE</b> .....	<b>25</b>
<i>meeting tables</i>	
<b>DESCRIZIONE TECNICA</b> .....	<b>26</b>
<b>TECHNICAL DESCRIPTIONS</b> .....	<b>28</b>
<b>INDICE DEI CODICI</b> .....	<b>30</b>
<i>codes index</i>	

**N.B.: ALTRE TIPOLOGIE DI MOBILI CONTENITORI  
E LIBRERIE A SPALLA UNICA  
SONO INSERITI NEL CAPITOLO "CONTENITORI UNIVERSALI EVO"  
PLEASE NOTE: you can find other cabinet models  
and bookcases with shared side panel in the section "UNIVERSAL CABINETS EVO"**

• **PASSACAVO SU GAMBA METALLICA**

MATERIALE: Plastica

COLORI: Bianco

CARATTERISTICA:

- 1) Consente l'alloggiamento di prese Schuko e RJ all'interno del traverso della gamba
- 2) Predisposto per il fissaggio dei sostegni per schermi in metacrilato

• **WIRE-MANAGEMENT ON TOP OF THE METAL LEG**

MATERIAL: Plastic

COLOURS: White

FEATURE:

- 1) it allows the lodging of Schuko sockets and RJ inside the top of the leg
- 2) Predisposed for the fixing of methacrylate screens



• **TRAVI DI SUPPORTO**

MATERIALE: Metallo 40 x 30 sp 1.5mm

FINITURA: Verniciatura a polvere epossidica

COLORE: Bianco

CARATTERISTICA: Il montaggio della trave alla struttura è rapidissimo ed avviene ad incastro tramite un sistema di terminali di bloccaggio composto da due parti:

- A) Testata trave con maschio a coda di rondine, già premontata alle estremità
- B) Blocchetto di riscontro con cava a coda di rondine viene dato in dotazione con la gamba scrivania (sia metallica che pannellata) o con i mobili portanti per scrivania (porta-cpu, cassetiera, contenitori)

• **SUPPORT BEAMS**

MATERIAL: Metal 40x30 thick mm 1.5

FINISH: Painted with epoxy powder

COLOURS: White

FEATURE: The fixing of the beam to the structure is fast and is wedged in by means of blocking system composed by 2 pieces:

- A) Feather beam header, already assembled to the ends
- B) Block shaped to contain the feather beam header, supplied with the desk leg (metallic or panels) or with others supports such as cabinets for desk (cpu container, fix pedestal, desk cabinets)



#### • PIANI DI LAVORO

**MATERIALE:** pannelli di particelle di legno sp. mm 25 nobilitati in melaminico  
**COLORI:** ROVERE 03, NOCE PAVIA 06, BIANCO BR.69  
**CARATTERISTICA:** i bordi perimetrali sono in ABS sp. mm 2 colore bianco in abbinamento alle strutture.

#### • WORKTOPS

**MATERIAL:** Made with 25 mm particleboard panels melamine-faced  
**COLOURS:** OAK 03, PAVIA WALNUT 06, BR. WHITE 69  
**FEATURE:** the perimeter shaped borders are in 2 mm ABS white colour matching the frame.

#### • SCHERMI DIVISORI

**MATERIALE:** Metacrilato sp. 4mm  
**COLORI:** Bianco  
**CARATTERISTICA:** Idonei al montaggio su gambe metalliche e sui vani aperti degli storage

#### • DIVIDING SCREENS

**MATERIAL:** Methacrylate thick. 4mm  
**COLOURS:** White  
**FEATURE:** They're suitable for fixing on metal legs and open space of the storage

**CARTELLA COLORI**  
colours samples card



**RIVESTIMENTO IN TESSUTO PER CUSCINO CASSETTIERA SU RUOTE**  
fabric cushion for pedestal on wheels

Cat. F	<b>POLIESTERE STRETCH IGNIFUGO</b> 100% poliestere FR riciclato Martindale 50.000		<b>FIRE-RETARDANT STRETCH POLYESTER</b> 100% polyester FR recycled Martindale 50.000		
	<p><b>321</b> GIALLO FRESIA   FREESIA YELLOW</p>	<p><b>320</b> AZZURRO SKY   SKY BLUE</p>	<p><b>322</b> AMARANTO   AMARANTH</p>	<p><b>323</b> VERDE BOSCO   WOOD GREEN</p>	<p><b>327</b> GRIGIO   GREY</p>
	<p><b>330</b> MATTONE   BRICK RED</p>	<p><b>331</b> ARANCIO   ORANGE</p>	<p><b>332</b> ROSSO   RED</p>	<p><b>333</b> VERDE ACIDO   ACID GREEN</p>	<p><b>334</b> BLU   BLUE</p>



**DETTAGLIO DIMENSIONI SCRIVANIE**

*details of desks dimensions*

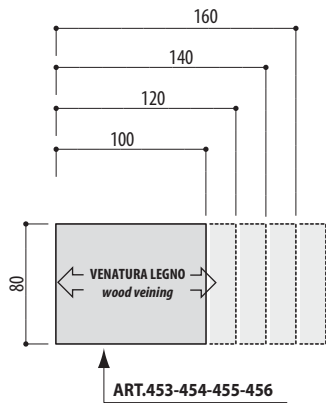

ART.461-463 DX(right)  
ART.466-468 SX(left)

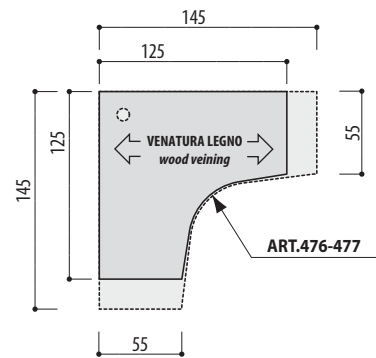
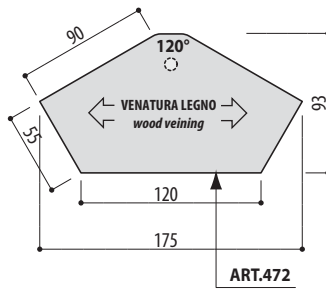
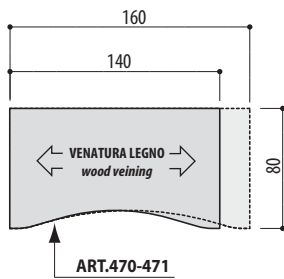
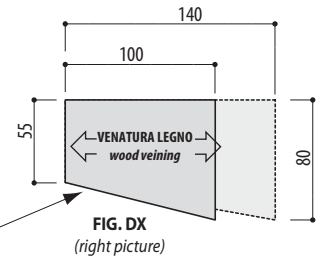

**PIANI PER STORAGE**  
*desk tops for storage*

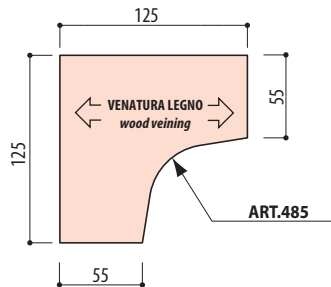

**PER SCHEMA DI UTILIZZO VEDI PAG.18**  
*for fact-sheet see page 18*

**TAVOLI RIUNIONE**  
*meeting tables*

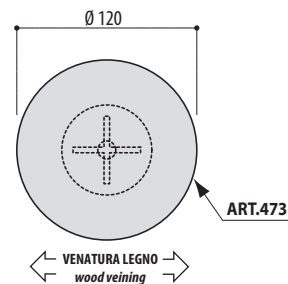
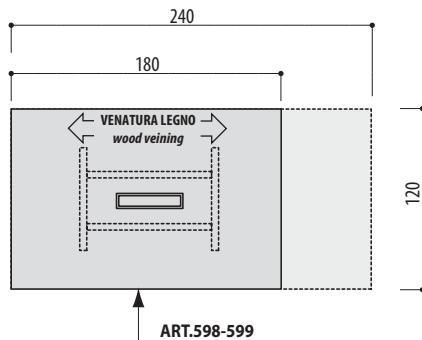

LOGIC

**TABELLE DIMENSIONI SCRIVANIE CON I DIVERSI BASAMENTI DI SUPPORTO***information sheet for dimensions of desks with support basements*

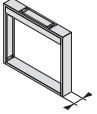
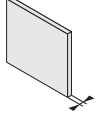
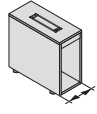
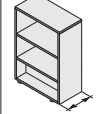
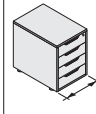
					<b>DIMENSIONI PIANI SCRIVANIE LINEARI</b> linear desk tops dimensions				
L.12	L.5	L.35	L.40	L.55	L.100	L.120	L.140	L.160	
<b>QUANTITA' / quantity</b>					<b>DIMENSIONI TOTALI / max sizes</b>				
2					124	144	164	184	
1	1				117	137	157	177	
1		1			147	167	187	207	
1			1		152	172	192	212	
1				1	167	187	207	227	
	2				110	130	150	170	
	1	1			140	160	180	200	
	1		1		145	165	185	205	
	1			1	160	180	200	220	
		2			170	190	210	230	
		1	1		175	195	215	235	
		1		1	190	210	230	250	
			2		180	200	220	240	
			1	1	195	215	235	255	
				2	210	230	250	270	

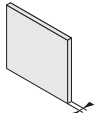
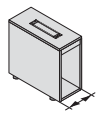
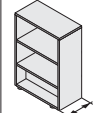
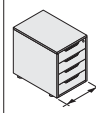
				<b>DIMENSIONI PIANI SCRIVANIA PER STORAGE</b> desk tops dimensions for storage				
L.5	L.35	L.40	L.55	L.125	L.145			
<b>QUANTITA' / quantity</b>				<b>DIMENSIONI TOTALI / max sizes</b>				
2				135	155			
	1			160	180			
		1		165	185			
			1	180	200			
2				135	155			
1	1			165	185			
1		1		170	190			
1			1	185	205			
		2		195	215			
		1	1	200	220			
		1		215	235			
			2	205	225			
			1	220	240			
			2	235	255			

**MISURE ESPRESSE IN CM**  
sizes in cms

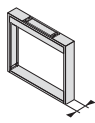
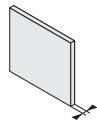
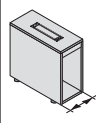
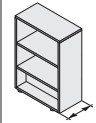
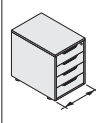

					DIMENSIONI PIANI DELTA delta tops dimensions			
L.12	L.5	L.35	L.40	L.55	L.100	L.140		
QUANTITA' / quantity					DIMENSIONI TOTALI / max sizes			
1	1				117	157		
1		1			147	187		
1			1		152	192		
1				1	167	207		
	2				110	150		
	1	1			140	180		
	1		1		145	185		
	1			1	160	200		
		2			170	210		
		1	1		175	215		
		1		1	190	230		
			1	1	195	235		
				2	210	250		

LOGIC

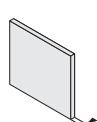
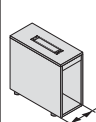
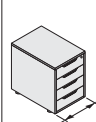
			DIMENSIONE LATI WORKSTATION 90° workstation 90° dimensions				LATO WORKST. 120° side workst. 120°
L.5	L.35	L.55	L.125	L.145		L.90	
QUANTITA' / quantity			DIMENSIONI TOTALI / max sizes				
1			130	150		95	
	1		160	180		125	
		1	180	200		145	

MISURE ESPRESSE IN CM  
sizes in cms



**PIANI SCRIVANIE LINEARI E PIANI WORKSTATION (travi di sostegno incluse)**PIANI sp. 25mm  
tops thick. 25mm

linear desk tops and workstation tops (support beams included)

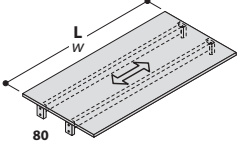
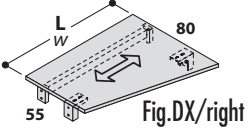
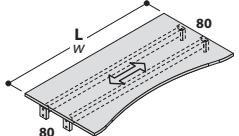
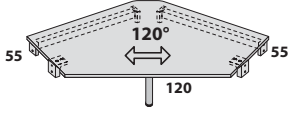
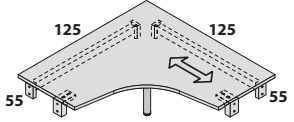
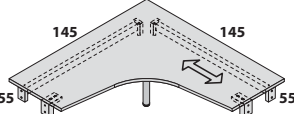
DESCRIZIONE description	L w	CODICE code	KG	M <sup>3</sup>	COLLI	PREZZO price	(*) CODICE FINITURA (* finish code)	
PIANI SCRIVANIE LINEARI PROF. CM 80 <i>linear desk tops deep 80 cms</i> 	L.100	154 <b>453</b> (*)	18	0,058	2	€ 146,00		
	L.120	154 <b>454</b> (*)	22	0,066	2	€ 165,00		
	L.140	154 <b>455</b> (*)	26	0,077	2	€ 180,00		
	L.160	154 <b>456</b> (*)	29	0,088	2	€ 208,00		
	L. x p.80 x H.2,5							
PIANI SCRIVANIE DELTA PROF. CM 55/80 <i>delta desk tops deep 55/80 cms</i> 	DX right	L.100	154 <b>461</b> (*)	18	0,053	3	€ 133,00	
		L.140	154 <b>463</b> (*)	26	0,075	3	€ 164,00	
	SX left	L.100	154 <b>466</b> (*)	18	0,053	3	€ 133,00	
		L.140	154 <b>468</b> (*)	26	0,075	3	€ 164,00	
	L. x p.55/80 x H.2,5							
PIANI SCRIVANIE LINEARI SAGOMATE <i>shaped linear desk tops</i> 	L.140	154 <b>470</b> (*)	23	0,077	2	€ 199,00		
	L.160	154 <b>471</b> (*)	26	0,088	2	€ 226,00		
	L. x p.80 x H.2,5							
PIANO WORKSTATION 120° <i>120° workstation top</i> 		154 <b>472</b> (*)	28	0,113	4	€ 286,00		
	L.175 x p.93 x H.72							
PIANO WORKSTATION L.125x125 <i>workstation top w 125x125 cms</i> 		154 <b>476</b> (*)	30	0,115	4	€ 289,00		
	L.125 x p.125 x H.72							
PIANO WORKSTATION L.145x145 <i>workstation top w 145x145 cms</i> 		154 <b>477</b> (*)	35	0,140	4	€ 331,00		
	L.145 x p.145 x H.72							

(*)	PIANO	BORDO	top	edge
400	BIANCO BR.	BIANCO BR.	br. white	br. white
403	ROVERE	BIANCO BR.	oak	br. white
466	NOCE PAVIA	BIANCO BR.	pavia walnut	br. white

**SCHEMA BASAMENTI UTILIZZABILI A LIVELLO DEL PIANO DI LAVORO**

support elements fact-sheet

**PER SCRIVANIE SINGOLE  
PROF. CM 80  
for single desk tops deep 31½"**

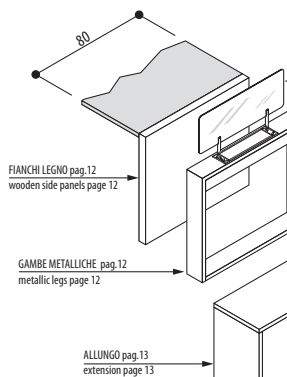

POSSIBILITÀ DI MONTAGGIO  
SCHERMO LATERALE L.65 ART.601 pag.24  
possibility of assembling  
side screen w 65cms  
art. 601 pag.24

**PER SCRIVANIE SINGOLE  
PROF. CM 55  
for single desk tops deep 21¾"**

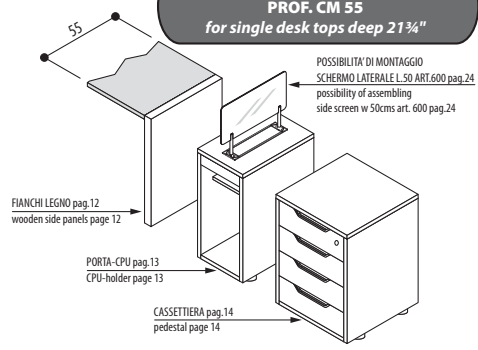

POSSIBILITÀ DI MONTAGGIO  
SCHERMO LATERALE L.50 ART.600 pag.24  
possibility of assembling  
side screen w 50cms art. 600 pag.24

**PER SCRIVANIE CONDIVISE  
PROF. CM 116 (55+55)  
for sharing desk tops deep 116 cms (55+55)**

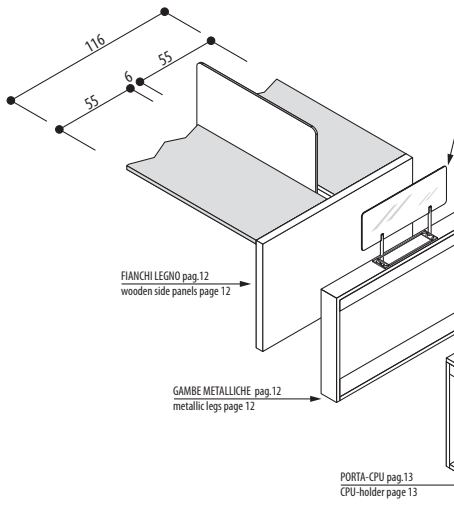

POSSIBILITÀ DI MONTAGGIO  
SCHERMO LATERALE L.65 ART.601 pag.24  
possibility of assembling  
side screen w 65 cms art. 601 pag.24

POSSIBILITÀ DI MONTAGGIO  
2 SCHERMI LATERALI L.50 ART.600 pag.24  
possibility of assembling  
2 side screens w 50 cms art. 600 pag.24

MOBILI PORTANTI  
CON CASSETTO ESTRAIBILE pag.14  
support cabinets  
with pull-out drawer page 14

**SONO DISPONIBILI BASAMENTI PER POSIZIONE CENTRALE O TERMINALE!  
the supports are available for central or terminal position!**

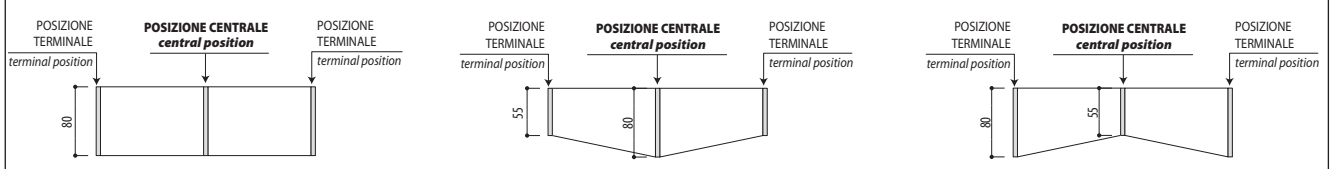

LOGIC

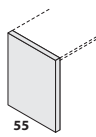
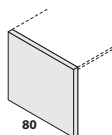
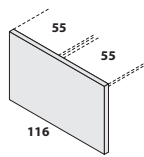
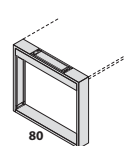
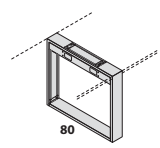
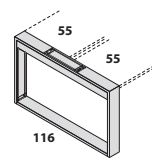
FIANCHI LEGNO PER SCRIVANIE							
wooden side panels for desks							
DESCRIZIONE description	P d	CODICE code	KG	M <sup>3</sup>	COLLI	PREZZO price	(*) CODICE FINITURA (*) finish code
FIANCO TERMINALE DX O SX (PROF. CM 55) <i>right or left terminal side-panel (deep 55 cms)</i>   55  L.5 x p.55 x H.72	P. 55	154 491 (*)	15	0,029	1	€ 57,00	
FIANCO TERMINALE DX O SX (PROF. CM 80) <i>right or left terminal side-panel (deep 80 cms)</i>   80  L.5 x p.80 x H.72	P. 80	154 493 (*)	20	0,044	1	€ 76,00	
							(*) 400 BIANCO BR. br. white
FIANCO TERMINALE DX O SX (PROF. CM 116) <i>right or left terminal side-panel (deep 116 cms)</i>   55 116  L.5 x p.116 x H.72	P. 116	154 495 (*)	30	0,065	1	€ 101,00	
GAMBE METALLICHE PER SCRIVANIE							
metallic legs for single desks							
GAMBA TERMINALE DX O SX (PROF. CM 80) <b>CON PASSACAVO</b> <i>right or left terminal leg (deep 80 cms) with wire-manager</i>   80  L.12 x p.80 x H.72		<b>CON PASSACAVO</b> with wire-manager					
	P. 80	154 501 (*)	10	0,085	1	€ 152,00	
GAMBA CENTRALE (PROF. CM 80) <b>CON PASSACAVO</b> <i>central leg (deep 80 cms) with wire-manager</i>   80  L.12 x p.80 x H.72		<b>CON PASSACAVO</b> with wire-manager					
	P. 80	154 504 (*)	10	0,085	1	€ 156,00	(*) 400 BIANCO BR. br. white
GAMBA TERMINALE DX O SX (PROF. CM 116) <b>CON PASSACAVO</b> <i>right or left terminal leg (deep 116 cms) with wire-manager</i>   55 116  L.12 x p.116 x H.72		<b>CON PASSACAVO</b> with wire-manager					
	P. 116	154 509 (*)	13	0,120	1	€ 197,00	



**ALLUNGO PER SCRIVANIE SINGOLE PROF. CM 80***extension for single desks deep 80 cms*

DESCRIZIONE <i>description</i>	L w	CODICE <i>code</i>	KG	M <sup>3</sup>	COLLI	PREZZO <i>price</i>	(*) CODICE FINITURA (*) <i>finish code</i>
ALLUNGO TERMINALE O CENTRALE <i>terminal or central extension</i>  L.35 x p.150 x H.72		<b>CON PASSACAVO with wire-manager</b>					
	L.35	<b>154 590 (*)</b>	45	0,128	4	<b>€ 257,00</b>	(*) 400 BIANCO BR. <i>br. white</i>

**PORTA-CPU PER SCRIVANIE SINGOLE O CONDIVISE***CPU-holder for single or sharing desks*

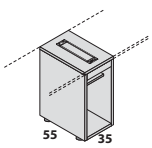
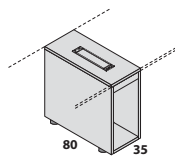
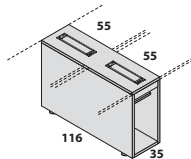
PORTA-CPU TERMINALE O CENTRALE (PROF. CM 55) <i>terminal or central CPU-holder (deep 55 cms)</i>  L.35 x p.55 x H.72		<b>CON PASSACAVO with wire-manager</b>					
	L.35	<b>154 592 (*)</b>	30	0,072	2	<b>€ 146,00</b>	
PORTA-CPU TERMINALE O CENTRALE (PROF. CM 80) <i>terminal or central CPU-holder (deep 80 cms)</i>  L.35 x p.80 x H.72		<b>CON PASSACAVO with wire-manager</b>					
	L.35	<b>154 593 (*)</b>	32	0,086	2	<b>€ 180,00</b>	(*) 400 BIANCO BR. <i>br. white</i>
PORTA-CPU TERMINALE O CENTRALE (PROF. CM 116) <i>terminal or central CPU-holder (deep 116 cms)</i>  L.35 x p.116 x H.72		<b>CON PASSACAVO with wire-manager</b>					
	L.35	<b>154 594 (*)</b>	40	0,110	1	<b>€ 252,00</b>	



LOGIC

**MOBILI PORTANTI PER SCRIVANIE SINGOLE**

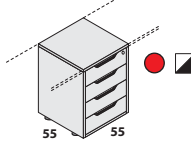
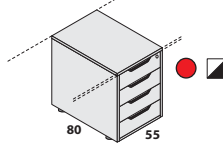
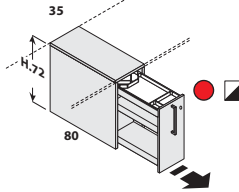
*support cabinets for single desks*

DESCRIZIONE <i>description</i>	L <i>w</i>	CODICE <i>code</i>	KG	M <sup>3</sup>	COLLI	PREZZO <i>price</i>	(*) CODICE FINITURA <i>(*) finish code</i>
<p>MOBILE PORTANTE 4 CASSETTI (CON SERRATURA) PER SCRIVANIE PROF. CM 55 <i>support cabinet with 4 drawers (with lock) for desks deep 55 cms</i></p>  <p>L.55 x p.55 x H.72</p>							
		<b>CASSETTI IN LEGNO</b> <i>wooden drawers</i>	<b>CON CHIUSURA AMMORTIZZATA</b> <i>with soft-close</i>				
	L.55	154 <b>526</b> (*)	36	0,293	2	<b>€ 378,00</b>	
<p>MOBILE PORTANTE 4 CASSETTI (CON SERRATURA) PER SCRIVANIE PROF. CM 80 <i>support cabinet with 4 drawers (with lock) for desks deep 80 cms</i></p>  <p>L.55 x p.80 x H.72</p>							
		<b>CASSETTI IN LEGNO</b> <i>wooden drawers</i>	<b>CON CHIUSURA AMMORTIZZATA</b> <i>with soft-close</i>				
	L.55	154 <b>529</b> (*)	43	0,426	2	<b>€ 467,00</b>	
							(*)
	400	BIANCO BR.	br. white				
<p>MOBILE PORTANTE CON CASSETTO ESTRAIBILE L.35 (CON SERRATURA) PER SCRIVANIE PROF. CM 80 <i>support cabinet with pull-out drawer w 35 cms (with lock) for desks deep 80 cms</i></p>  <p>L.35 x p.80 x H.72</p>							
	L.35	154 <b>570</b> (*)	52,5	0,184	5	<b>€ 495,00</b>	

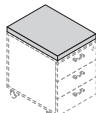

CASSETTIERE SU RUOTE <i>pedestal on wheels</i>																																											
DESCRIZIONE <i>description</i>	L <i>w</i>	CODICE <i>code</i>	KG	M <sup>3</sup>	COLLI	PREZZO <i>price</i>	(*) CODICE FINITURA <i>(*) finish code</i>																																				
CASSETTIERA 3 CASSETTI SU RUOTE (CON SERRATURA) <i>pedestal 3 drawers on wheels (with lock)</i>    L.42,1 x p.55,2 x H.57,3	L42	CASSETTI IN LEGNO <i>wooden drawers</i>		CON CHIUSURA AMMORTIZZATA <i>with soft-close</i>			€ 228,00																																				
		154	675 (*)	24	0,152	1																																					
CASSETTIERA-CLASSIFICATORE SU RUOTE (CON SERRATURA) <i>pedestal with file-drawer on wheels (with lock)</i>    L.42,1 x p.55,2 x H.57,3	L42	CASSETTI IN LEGNO <i>wooden drawers</i>		CON CHIUSURA AMMORTIZZATA <i>with soft-close</i>			€ 251,00																																				
		154	677 (*)	26	0,152	1																																					
CUSCINO PER CASSETTIERE SU RUOTE <i>cushion for pedestals on wheels</i>    L.42,1 x p.55,2 x H.3	L42,1	CASSETTI IN LEGNO <i>wooden drawers</i>		CON CHIUSURA AMMORTIZZATA <i>with soft-close</i>			€ 51,00																																				
		114	956 (*)	2	0,020	1																																					
							<table border="1"> <thead> <tr> <th>(*)</th> <th>FRONTALI</th> <th>STRUTTURA</th> <th><i>fronTS</i></th> <th><i>structure</i></th> </tr> </thead> <tbody> <tr> <td>400</td> <td>BIANCO BR.</td> <td>BIANCO BR.</td> <td><i>br. white</i></td> <td><i>br. white</i></td> </tr> <tr> <td>403</td> <td>ROVERE</td> <td>BIANCO BR.</td> <td><i>oak</i></td> <td><i>br. white</i></td> </tr> <tr> <td>466</td> <td>NOCE PAVIA</td> <td>BIANCO BR.</td> <td><i>pavia walnut</i></td> <td><i>br. white</i></td> </tr> </tbody> </table>	(*)	FRONTALI	STRUTTURA	<i>fronTS</i>	<i>structure</i>	400	BIANCO BR.	BIANCO BR.	<i>br. white</i>	<i>br. white</i>	403	ROVERE	BIANCO BR.	<i>oak</i>	<i>br. white</i>	466	NOCE PAVIA	BIANCO BR.	<i>pavia walnut</i>	<i>br. white</i>																
(*)	FRONTALI	STRUTTURA	<i>fronTS</i>	<i>structure</i>																																							
400	BIANCO BR.	BIANCO BR.	<i>br. white</i>	<i>br. white</i>																																							
403	ROVERE	BIANCO BR.	<i>oak</i>	<i>br. white</i>																																							
466	NOCE PAVIA	BIANCO BR.	<i>pavia walnut</i>	<i>br. white</i>																																							
							<table border="1"> <thead> <tr> <th>(*)</th> <th>TESSUTO POLIESTERE STRETCH IGNIFUGO</th> <th><i>fire-retardant stretch polyester fabric</i></th> </tr> </thead> <tbody> <tr> <td>320</td> <td>AZZURRO SKY</td> <td><i>sky blue</i></td> </tr> <tr> <td>321</td> <td>GIALLO FRESIA</td> <td><i>freesia yellow</i></td> </tr> <tr> <td>322</td> <td>AMARANTO</td> <td><i>amaranth</i></td> </tr> <tr> <td>323</td> <td>VERDE BOSCO</td> <td><i>wood green</i></td> </tr> <tr> <td>327</td> <td>GRIGIO</td> <td><i>grey</i></td> </tr> <tr> <td>328</td> <td>TORTORA</td> <td><i>grey beige</i></td> </tr> <tr> <td>330</td> <td>MATONE</td> <td><i>brick red</i></td> </tr> <tr> <td>331</td> <td>ARANCIO</td> <td><i>orange</i></td> </tr> <tr> <td>332</td> <td>ROSSO</td> <td><i>red</i></td> </tr> <tr> <td>333</td> <td>VERDE ACIDO</td> <td><i>acid green</i></td> </tr> <tr> <td>334</td> <td>BLU</td> <td><i>blue</i></td> </tr> </tbody> </table>	(*)	TESSUTO POLIESTERE STRETCH IGNIFUGO	<i>fire-retardant stretch polyester fabric</i>	320	AZZURRO SKY	<i>sky blue</i>	321	GIALLO FRESIA	<i>freesia yellow</i>	322	AMARANTO	<i>amaranth</i>	323	VERDE BOSCO	<i>wood green</i>	327	GRIGIO	<i>grey</i>	328	TORTORA	<i>grey beige</i>	330	MATONE	<i>brick red</i>	331	ARANCIO	<i>orange</i>	332	ROSSO	<i>red</i>	333	VERDE ACIDO	<i>acid green</i>	334	BLU	<i>blue</i>
(*)	TESSUTO POLIESTERE STRETCH IGNIFUGO	<i>fire-retardant stretch polyester fabric</i>																																									
320	AZZURRO SKY	<i>sky blue</i>																																									
321	GIALLO FRESIA	<i>freesia yellow</i>																																									
322	AMARANTO	<i>amaranth</i>																																									
323	VERDE BOSCO	<i>wood green</i>																																									
327	GRIGIO	<i>grey</i>																																									
328	TORTORA	<i>grey beige</i>																																									
330	MATONE	<i>brick red</i>																																									
331	ARANCIO	<i>orange</i>																																									
332	ROSSO	<i>red</i>																																									
333	VERDE ACIDO	<i>acid green</i>																																									
334	BLU	<i>blue</i>																																									

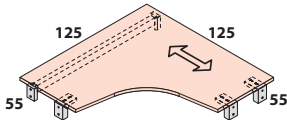
PIANI WORKSTATION PER STORAGE (travi incluse) <i>workstation tops for storage (support beams included)</i>						PIANO sp. 25mm <i>top thick. 25mm</i>	PER SCHEMA DI UTILIZZO VEDI PAG.18 <i>for fact-sheet see page 18</i>																				
DESCRIZIONE <i>description</i>	L <i>w</i>	CODICE <i>code</i>	KG	M <sup>3</sup>	COLLI	PREZZO <i>price</i>	(*) CODICE FINITURA <i>(*) finish code</i>																				
PIANO WORKSTATION L.125x125 <i>workstation top w 125x125 cms</i>    L.125 x p.125 x H.2,5							€ 219,00																				
		154	485 (*)	30	0,086	4																					
							<table border="1"> <thead> <tr> <th>(*)</th> <th>PIANO</th> <th>BORDO</th> <th><i>top</i></th> <th><i>edge</i></th> </tr> </thead> <tbody> <tr> <td>400</td> <td>BIANCO BR.</td> <td>BIANCO BR.</td> <td><i>br. white</i></td> <td><i>br. white</i></td> </tr> <tr> <td>403</td> <td>ROVERE</td> <td>BIANCO BR.</td> <td><i>oak</i></td> <td><i>br. white</i></td> </tr> <tr> <td>466</td> <td>NOCE PAVIA</td> <td>BIANCO BR.</td> <td><i>pavia walnut</i></td> <td><i>br. white</i></td> </tr> </tbody> </table>	(*)	PIANO	BORDO	<i>top</i>	<i>edge</i>	400	BIANCO BR.	BIANCO BR.	<i>br. white</i>	<i>br. white</i>	403	ROVERE	BIANCO BR.	<i>oak</i>	<i>br. white</i>	466	NOCE PAVIA	BIANCO BR.	<i>pavia walnut</i>	<i>br. white</i>
(*)	PIANO	BORDO	<i>top</i>	<i>edge</i>																							
400	BIANCO BR.	BIANCO BR.	<i>br. white</i>	<i>br. white</i>																							
403	ROVERE	BIANCO BR.	<i>oak</i>	<i>br. white</i>																							
466	NOCE PAVIA	BIANCO BR.	<i>pavia walnut</i>	<i>br. white</i>																							

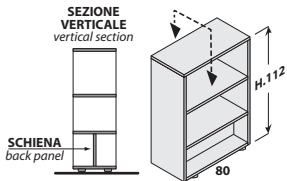
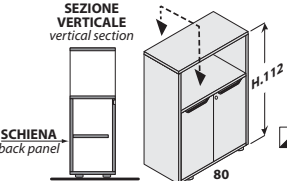
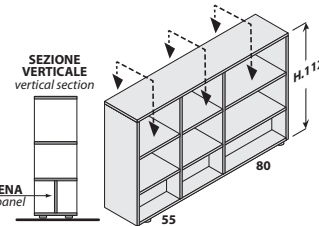
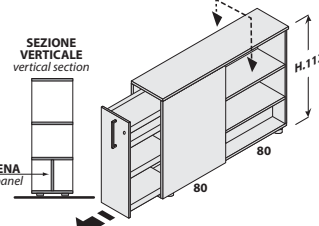
STORAGE H.112 PER SCRIVANIE storage h 44 1/4" for desks							
DESCRIZIONE description	L w	CODICE code	KG	M <sup>3</sup>	COLLI	PREZZO price	(*) CODICE FINITURA (*) finish code
<p>STORAGE A GIORNO L.80 open storage w 80 cms</p>  <p>L.80 x p.40 x H.112</p>	L.80	154 585 (*)	34	0,093	2	€ 199,00	
<p>STORAGE L.80 CON 2 ANTE LEGNO BASSE CON SERRATURA storage w 80 cms with 2 low wooden doors with lock</p>  <p>L.80 x p.40 x H.112</p>	L.80	154 586 (*)	42	0,136	3	€ 279,00	
<p>STORAGE AGGREGABILE A SCRIVANIE PROF. CM 55-80 storage for desk tops deep 55-80 cms</p>  <p>L.185 x p.40 x H.112</p>	L.185	154 578 (*)	91	0,206	3	€ 411,00	(*) BIANCO BR. br. white
<p>STORAGE AGGREGABILE A SCRIVANIE PROF. CM 80 storage for desk tops deep 80 cms</p>  <p>L.160 x p.40 x H.112</p>	L.160	154 584 (*)	121	0,333	6	€ 741,00	

**ACCESSORI PER STORAGE**

*accessories for storage*

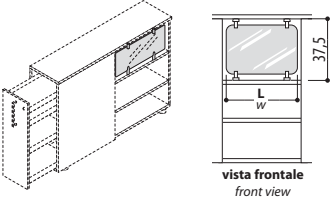
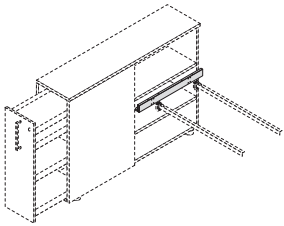
DESCRIZIONE <i>description</i>	L w	CODICE code	KG	M <sup>3</sup>	COLLI	PREZZO price	(*) CODICE FINITURA (*) finish code																											
<p>SCHERMI DIVISORI IN METACRILATO PER STORAGE <i>methacrylate dividing screen for storage</i></p>  <p>L. x sp.0,4 x H.37,5</p>	L.43,5	<b>154 605 (*)</b>	3	0,002	<b>2</b>	<b>€ 102,00</b>	<table border="1"> <thead> <tr> <th>(*)</th> <th>METACRILATO</th> <th><i>methacrylate</i></th> </tr> </thead> <tbody> <tr> <td><b>919</b></td> <td>BIANCO</td> <td><i>white</i></td> </tr> </tbody> </table>	(*)	METACRILATO	<i>methacrylate</i>	<b>919</b>	BIANCO	<i>white</i>																					
	(*)	METACRILATO	<i>methacrylate</i>																															
	<b>919</b>	BIANCO	<i>white</i>																															
	L.68,5	<b>154 607 (*)</b>	3	0,003	<b>2</b>	<b>€ 129,00</b>																												
<p>PROSPETTO INFORMATIVO <i>information sheet</i></p> <table border="1"> <thead> <tr> <th>L</th> <th>w</th> <th>SCHERMO screen</th> <th colspan="4">UTILIZZABILE SU STORAGE <i>usable on the storage</i></th> </tr> </thead> <tbody> <tr> <td>L.43,5</td> <td></td> <td><b>ART.605</b></td> <td colspan="4">ART.578</td> </tr> <tr> <td>L.68,5</td> <td></td> <td><b>ART.607</b></td> <td colspan="4">ART.578-584-585-586</td> </tr> </tbody> </table>							L	w	SCHERMO screen	UTILIZZABILE SU STORAGE <i>usable on the storage</i>				L.43,5		<b>ART.605</b>	ART.578				L.68,5		<b>ART.607</b>	ART.578-584-585-586										
L	w	SCHERMO screen	UTILIZZABILE SU STORAGE <i>usable on the storage</i>																															
L.43,5		<b>ART.605</b>	ART.578																															
L.68,5		<b>ART.607</b>	ART.578-584-585-586																															
<p>STAFFA PER ATTACCO PIANI A STORAGE <i>stirrup for desk top with connection at storage</i></p>  <p>L. x p.2 x H.7</p>	L.50	<b>154 615 (*)</b>	2	0,005	<b>1</b>	<b>€ 23,00</b>	<table border="1"> <thead> <tr> <th>(*)</th> <th>STAFFA</th> <th><i>stirrup</i></th> </tr> </thead> <tbody> <tr> <td><b>400</b></td> <td>BIANCO BR.</td> <td><i>br. white</i></td> </tr> </tbody> </table>	(*)	STAFFA	<i>stirrup</i>	<b>400</b>	BIANCO BR.	<i>br. white</i>																					
	(*)	STAFFA	<i>stirrup</i>																															
	<b>400</b>	BIANCO BR.	<i>br. white</i>																															
	L.75	<b>154 616 (*)</b>	3	0,005	<b>1</b>	<b>€ 32,00</b>																												
L.77,5	<b>154 617 (*)</b>	3	0,005	<b>1</b>	<b>€ 34,00</b>																													
<p>PROSPETTO INFORMATIVO <i>information sheet</i></p> <table border="1"> <thead> <tr> <th>L</th> <th>w</th> <th>STAFFA stirrup</th> <th colspan="4">UTILIZZABILE SU STORAGE <i>usable on the storage</i></th> </tr> </thead> <tbody> <tr> <td>L.50</td> <td></td> <td><b>ART.615</b></td> <td colspan="4">ART.578</td> </tr> <tr> <td>L.75</td> <td></td> <td><b>ART.616</b></td> <td colspan="4">ART.578-585</td> </tr> <tr> <td>L.77,5</td> <td></td> <td><b>ART.617</b></td> <td colspan="4">ART.584</td> </tr> </tbody> </table>							L	w	STAFFA stirrup	UTILIZZABILE SU STORAGE <i>usable on the storage</i>				L.50		<b>ART.615</b>	ART.578				L.75		<b>ART.616</b>	ART.578-585				L.77,5		<b>ART.617</b>	ART.584			
L	w	STAFFA stirrup	UTILIZZABILE SU STORAGE <i>usable on the storage</i>																															
L.50		<b>ART.615</b>	ART.578																															
L.75		<b>ART.616</b>	ART.578-585																															
L.77,5		<b>ART.617</b>	ART.584																															

**SCHEMA DI UTILIZZO STAFFE ART.615-616-617**  
*scheme of using art.615-616-617*

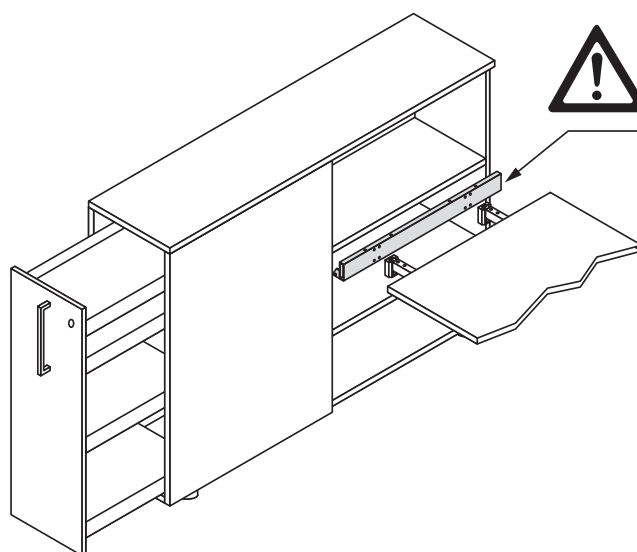

**LE STAFFE ART.615-616-617**  
PERMETTONO IL FISSAGGIO DELLE TESTATE (LATO CM 80 o 55)  
DEI PIANI SCRIVANIE O WORKSTATION  
NELLE PARTI A GIORNO DEGLI STORAGE

**the stirrups ART.615-616-617**  
*allow the fixing of the headings of the desk tops or workstation  
in the open space of the storage*

LOGIC

**SCHEMA BASE PER UTILIZZO PIANI AGGREGATI CON STORAGE**

*top for storage fact-sheet*

★ AGGREGAZIONE SUL **LATO CORTO** DEL PIANO  
fixing to the **shorter side** of the top

PIANI LINEARI O WORKSTATION  
linear or workstation tops

COMPOSIZIONE **SINGOLA O IN LINEA CON 2 O PIU' PIANI**  
single or linear composition with 2 or more tops

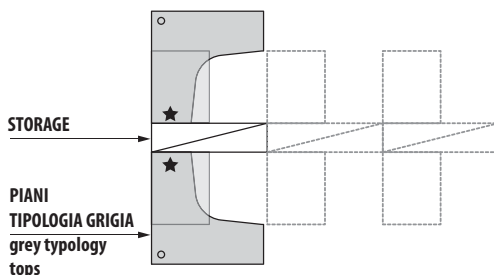

☆ AGGREGAZIONE SUL **LATO LUNGO** DEL PIANO  
fixing to the **longer side** of the top

PIANI LINEARI  
linear tops

COMPOSIZIONE **SINGOLA**  
single composition

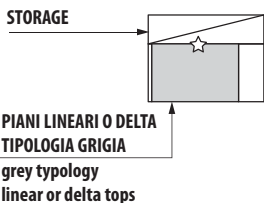

COMPOSIZIONE **IN LINEA CON 2 O PIU' PIANI**  
linear composition with 2 or more tops

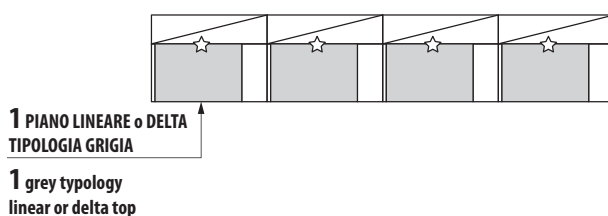

PIANI WORKSTATION  
workstation tops

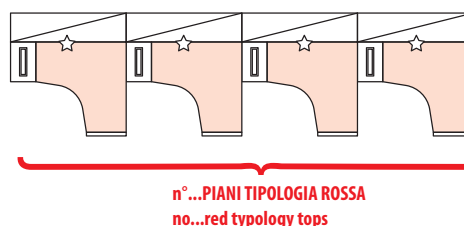
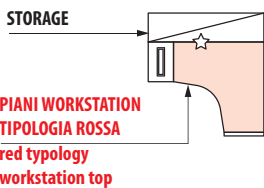

**ESEMPI DI AGGREGAZIONE SCRIVANIE CON STORAGE ART.585**

*assembling desks with storage art.585 examples*

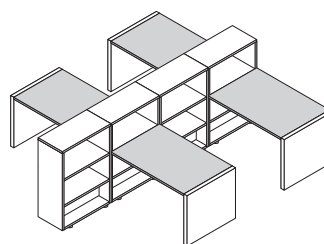
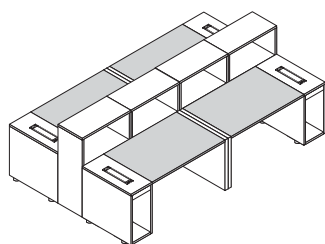
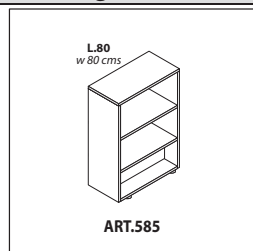

4 FIANCHI LEGNO TERMINALI ART.493  
4 terminal wooden side panels art.493

4 PIANI SCRIVANIE ART.454  
4 desk tops art.454

4 STORAGE L.80 ART.585  
4 storage w 80 cms art.585

4 PORTA-CPU ART.593  
4 CPU-holder art.593

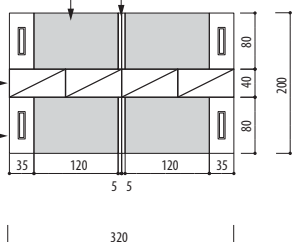

4 FIANCHI LEGNO TERMINALI ART.493  
4 terminal wooden side panels art.493

4 STAFFE ART.616  
4 strutils art.616

4 STORAGE L.80 ART.585  
4 storage w 80 cms art.585

4 PIANI SCRIVANIE ART.453  
4 desk tops art.453

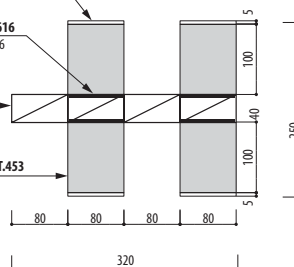

**ESEMPI DI AGGREGAZIONE SCRIVANIE CON STORAGE ART.584-585-586**

assembling desks with storage art.584-585-586 examples

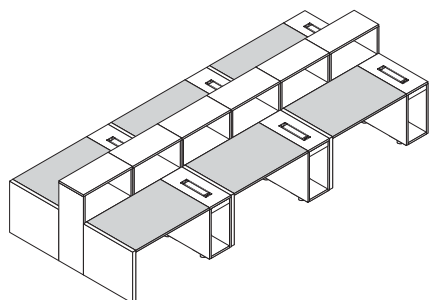
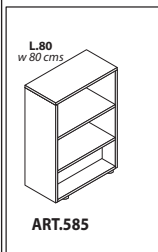

**6 PIANI SCRIVANIE L.120 ART.454**  
6 desk tops w 120 cms art.454

**6 STORAGE L.80 ART.585**  
6 storage w 80 cms art.585

**6 FIANCHI LEGNO TERMINALI ART.493**  
6 terminal wooden side panels art.493

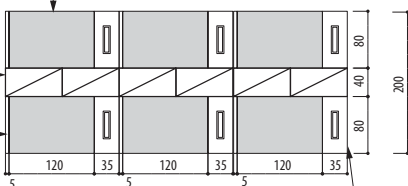

**6 PORTA-CPU ART.593**  
4 CPU-holder art.593

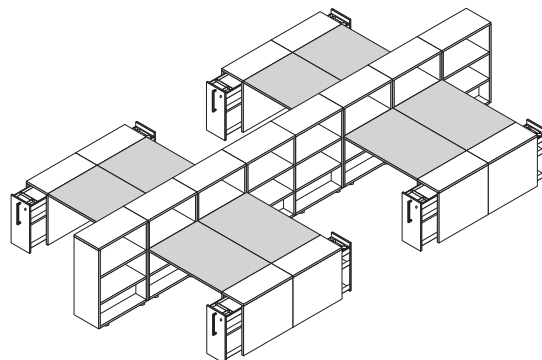

**8 MOBILI PORTANTI ART.570**  
8 support cabinets art.570

**8 STAFFE ART.616**  
8 stirrups art.616

**8 STORAGE L.80 ART.585**  
8 storage w 80 cms art.585

**8 PIANI SCRIVANIE ART.453**  
8 desk tops art.453

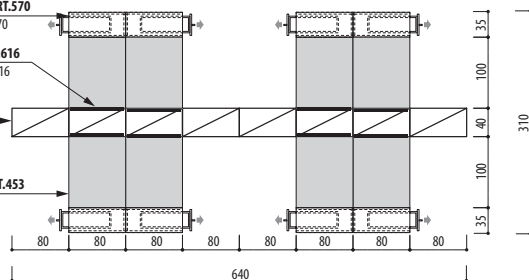

LOGIC

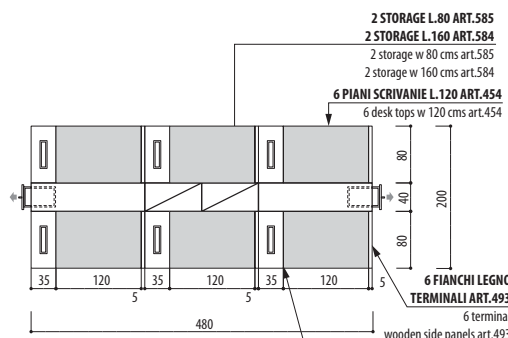
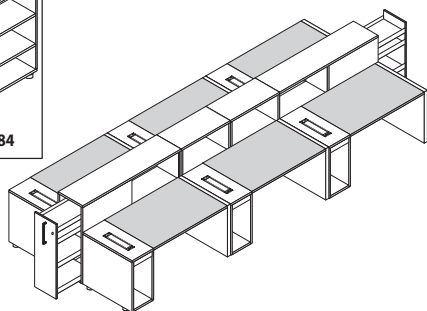
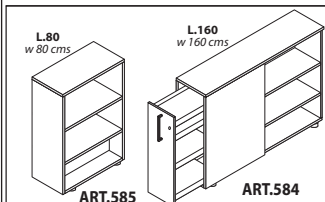

**2 STORAGE L.80 ART.585**  
**2 STORAGE L.160 ART.584**  
2 storage w 80 cms art.585  
2 storage w 160 cms art.584

**6 PIANI SCRIVANIE L.120 ART.454**  
6 desk tops w 120 cms art.454

**6 FIANCHI LEGNO TERMINALI ART.493**  
6 terminal wooden side panels art.493

**6 PORTA-CPU ART.593**  
6 CPU-holder art.593

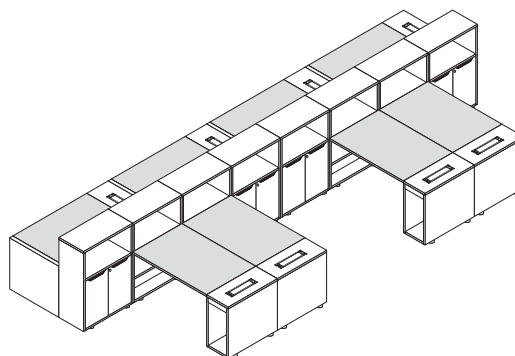
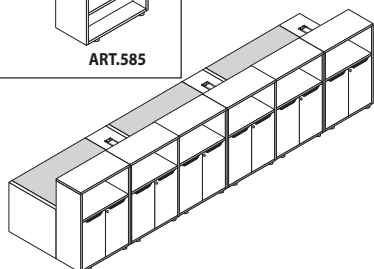
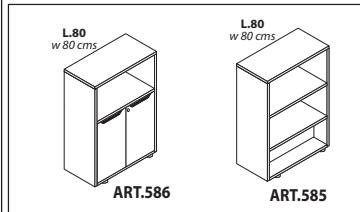

**3 PIANI L.120 ART.454**  
3 desk tops w 120 cms art.454

**3 FIANCHI LEGNO TERMINALI ART.493**  
3 terminal wooden side panels art.493

**6 STORAGE L.80 ART.586**  
6 storage w 80 cms art.586

**3 PORTA-CPU ART.593**  
3 CPU-holder art.593

**8 PIANI L.120 ART.454**  
8 desk tops w 120 cms art.454

**4 FIANCHI LEGNO TERMINALI ART.493**  
4 terminal wooden side panels art.493

**4 STAFFE ART.616**  
4 stirrups art.616

**4 STORAGE L.80 ART.585**  
**4 STORAGE L.80 ART.586**  
4 storage w 80 cms art.585  
4 storage w 80 cms art.586

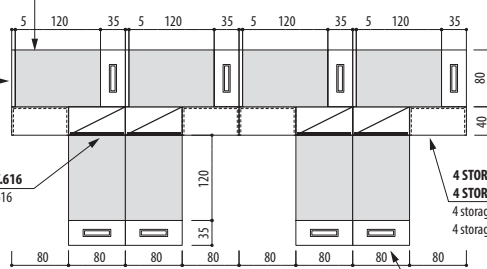

**8 PORTA-CPU ART.593**  
8 CPU-holder art.593



**ESEMPI DI AGGREGAZIONE SCRIVANIE CON STORAGE ART.578**

*assembling desks with storage art.578 examples*

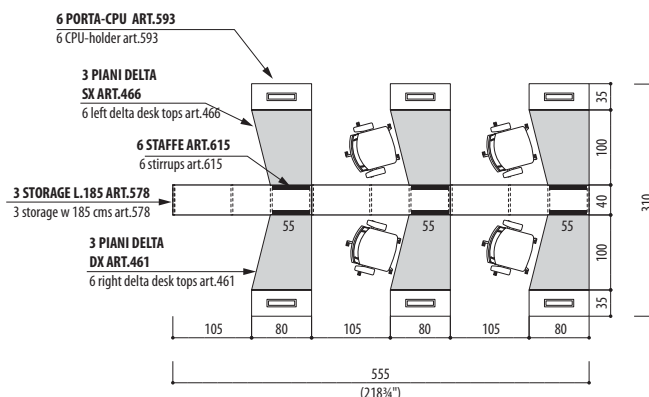
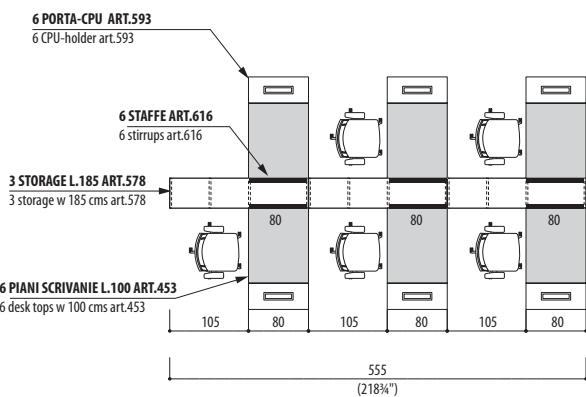
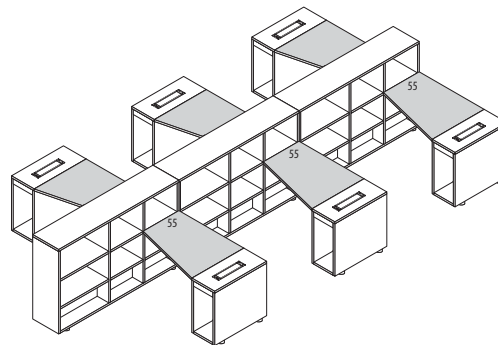
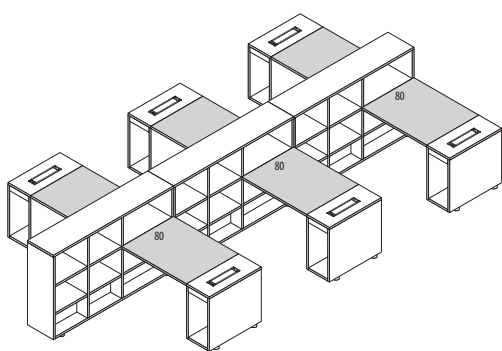
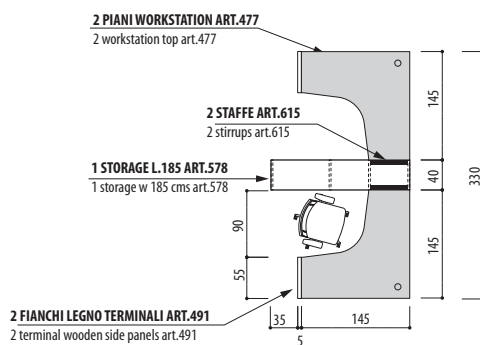
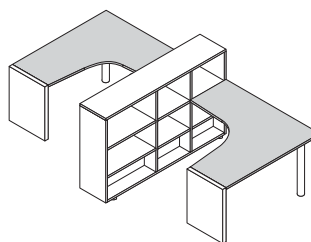
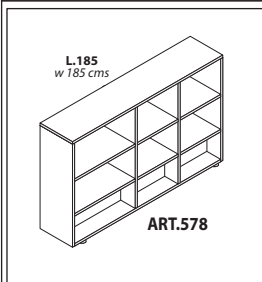

**ESEMPI DI AGGREGAZIONE SCRIVANIE CON STORAGE ART.584**

*assembling desks with storage art.584 examples*

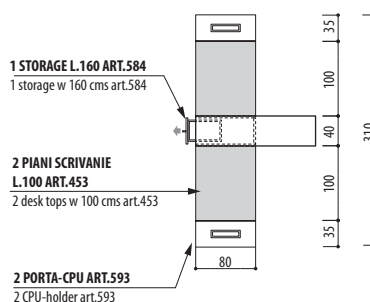
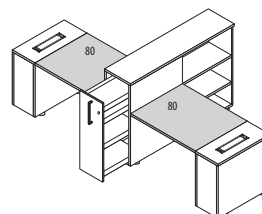
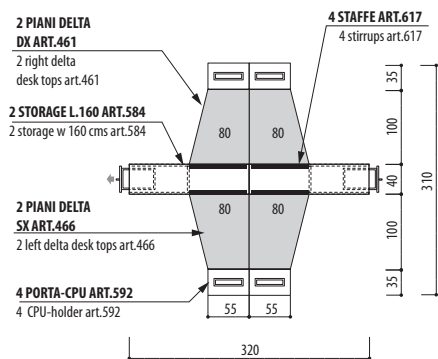
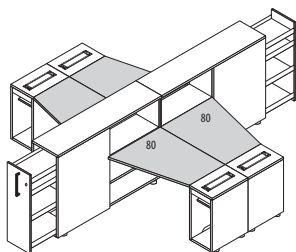
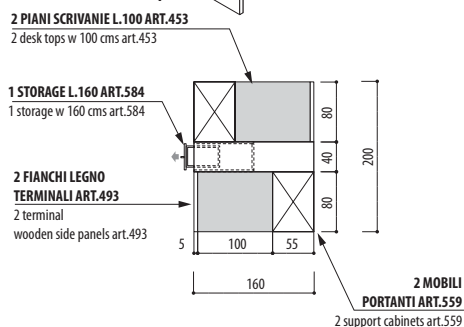
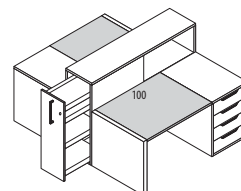
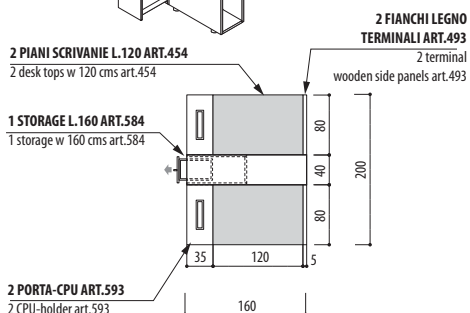
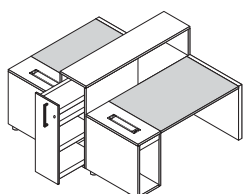
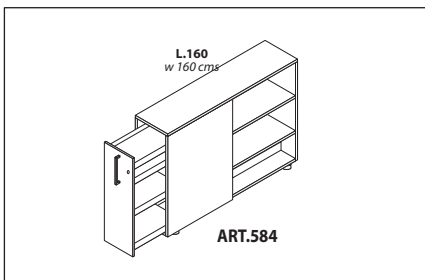

LOGIC

**ESEMPI DI AGGREGAZIONE SCRIVANIE CON STORAGE ART.584**

*assembling desks with storage art.584 examples*

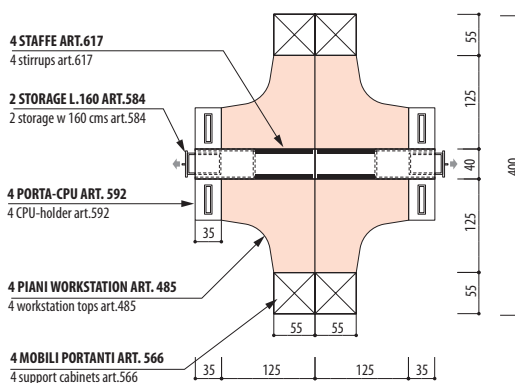
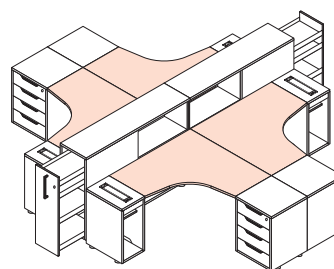
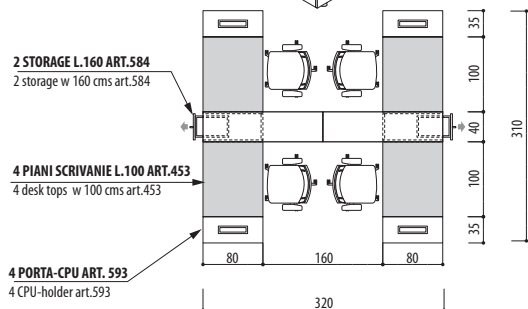
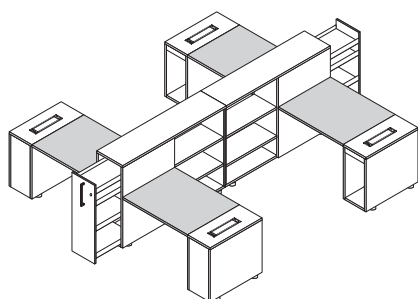
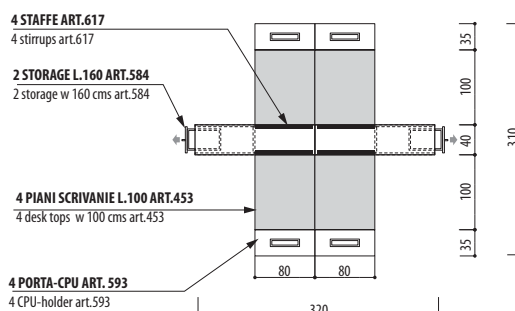
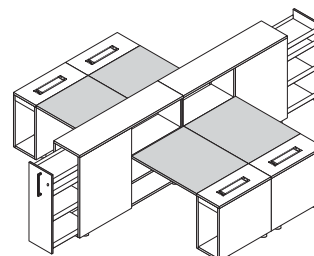
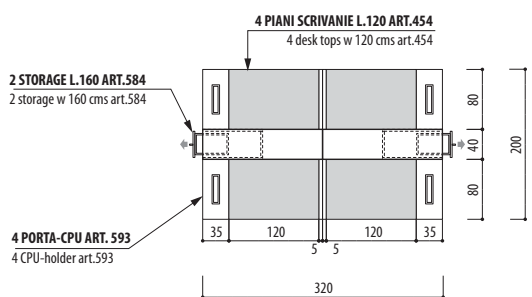
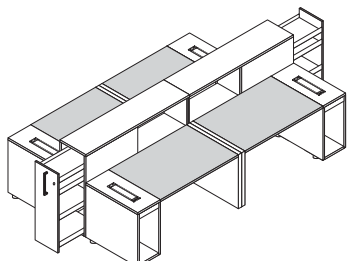
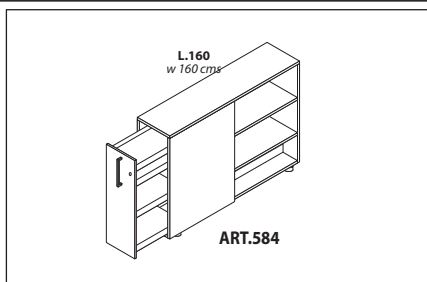



**PANNELLI FRONTALI E SCHERMI LATERALI IN METACRILATO**

front panels and methacrylate side screens

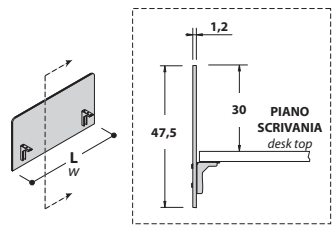
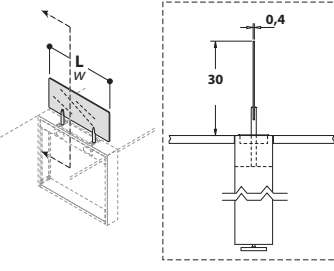
DESCRIZIONE description	L w	CODICE code	KG	M <sup>3</sup>	COLLI	PREZZO price	(*) CODICE FINITURA (*) finish code									
<b>PANNELLO FRONTALE IN MELAMINICO</b> CON STAFFE IN DOTAZIONE <i>melamine front panel included stirrups</i>  <p>Lx p.1,2 x H.47,5</p>		<b>MELAMINICO</b> melamine														
	L. 80	<b>154 711 (*)</b>	6	0,021	<b>2</b>	<b>€ 69,00</b>										
	L.100	<b>154 712 (*)</b>	8	0,025	<b>2</b>	<b>€ 76,00</b>	(*) <b>MELAMINICO / melamine</b> PANNELLO panel 400 BIANCO BR. br. white									
	L.120	<b>154 713 (*)</b>	9	0,029	<b>2</b>	<b>€ 84,00</b>										
	L.140	<b>154 715 (*)</b>	11	0,034	<b>2</b>	<b>€ 87,00</b>										
<b>SCHERMO LATERALE</b> side screen  <p>L. x sp.0,4 x H.30</p>	L.50	<b>154 600 (*)</b>	4	0,002	<b>2</b>	<b>€ 90,00</b>										
	L.65	<b>154 601 (*)</b>	5	0,002	<b>2</b>	<b>€ 95,00</b>										
	PROSPETTO INFORMATIVO information sheet		<table border="1"> <thead> <tr> <th>L w</th> <th>SCHERMO screen</th> <th>UTILIZZABILE SU usable on</th> </tr> </thead> <tbody> <tr> <td>L.50</td> <td><b>ART.600</b></td> <td>PORTA - CPU PROF. CM 55-116 CPU-holder deep 55-116 cms</td> </tr> <tr> <td>L.65</td> <td><b>ART.601</b></td> <td>GAMBE METALLICHE PROF.80-116 ALLUNGHI, PORTA-CPU PROF. CM 80 frame metal legs deep 80-116 cms extensions, CPU-holder deep 80 cms</td> </tr> </tbody> </table>		L w	SCHERMO screen	UTILIZZABILE SU usable on	L.50	<b>ART.600</b>	PORTA - CPU PROF. CM 55-116 CPU-holder deep 55-116 cms	L.65	<b>ART.601</b>	GAMBE METALLICHE PROF.80-116 ALLUNGHI, PORTA-CPU PROF. CM 80 frame metal legs deep 80-116 cms extensions, CPU-holder deep 80 cms			(*) <b>METACRILATO</b> methacrylate <b>919</b> BIANCO white
L w	SCHERMO screen	UTILIZZABILE SU usable on														
L.50	<b>ART.600</b>	PORTA - CPU PROF. CM 55-116 CPU-holder deep 55-116 cms														
L.65	<b>ART.601</b>	GAMBE METALLICHE PROF.80-116 ALLUNGHI, PORTA-CPU PROF. CM 80 frame metal legs deep 80-116 cms extensions, CPU-holder deep 80 cms														

**SCHEMA DI UTILIZZO PANNELLI FRONTALI**  
scheme of using front panels

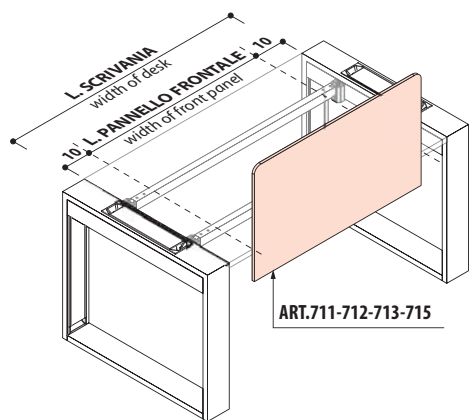

**ESEMPIO: SU UNA SCRIVANIA L.140**  
**ORDINARE IL PANNELLO FRONTALE L.120 ART.713**  
 example: on the desk w 140 cms  
 order the front panel w 120 cms ART.713





ART.711-712-713-715

PROSPETTO INFORMATIVO information sheet		
<b>LARGHEZZA PANNELLI FRONTALI</b> width of front panels		<b>UTILIZZABILE SU PIANI SCRIVANIE</b> usable on the desk tops
L.80	ART.711	L.100
L.100	ART.712	L.120-125
L.120	ART.713	L.140-145
L.140	ART.715	L.160

LOGIC

## ACCESSORI AGGANCIABILI SU PANNELLI FRONTALI

accessories fixed to front panels

DESCRIZIONE description	L w	CODICE code	KG	M <sup>3</sup>	COLLI	PREZZO price	(*) CODICE FINITURA (*) finish code	
PORTA-PENNE L.9 pen-holder w 3½"  L.9 x p.6,5 x H.9,4	L.9	154 737 (*)	1	0,002	1	€ 19,00		
PORTA-PENNE L.18 pen-holder w 7"  L.18 x p.6,5 x H.9,4	L.18	154 738 (*)	1	0,006	1	€ 22,00		
PORTA-CARTA paper-holder  L.31 x p.23,7 x H.9,4	L.31	154 739 (*)	1	0,014	1	€ 31,00		
LAVAGNA METALLICA metallic whiteboard  L.30,7 x p.2 x H.20,3	L.30,7	154 740 (*)	1	0,004	1	€ 28,00		
							(*)	
							400	BIANCO BR. br. white

## ACCESSORI DA APPOGGIARE

freestanding accessories

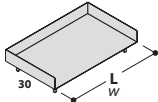
PORTA-CARTA paper-holder  L. x p.30 x H.11	L.50	154 732 (*)	1	0,030	1	€ 64,00		
	L.65	154 733 (*)	1,5	0,037	1	€ 67,00		
							(*)	
							400	BIANCO BR. br. white

## VASCHETTE PASSA-CAVI

plate cable channels

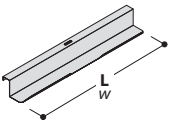
VASCHETTA PASSA-CAVI plate cable-channel  L. x p.11 x H.7	L.80	154 756 (*)	1	0,014	1	€ 22,00		
	L.100	154 757 (*)	1,5	0,014	1	€ 28,00		
	L.120	154 759 (*)	1,5	0,015	1	€ 30,00		
	L.140	154 760 (*)	2	0,021	1	€ 32,00		
							(*)	
							400	BIANCO BR. br. white

### SCHEMA DI UTILIZZO VASCHETTE PASSA-CAVI

scheme of using plate cable-channels

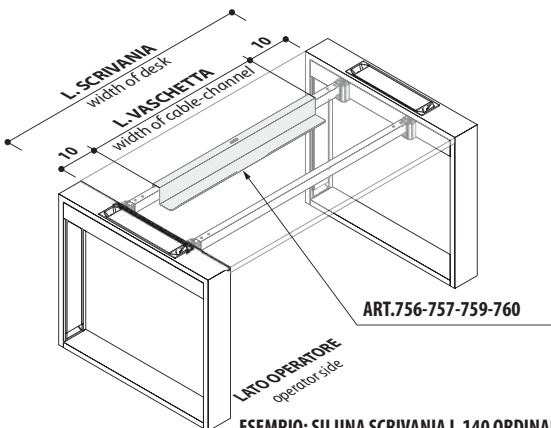

**ESEMPIO: SU UNA SCRIVANIA L.140 ORDINARE LA VASCHETTA L.120 ART.759**  
example: on the desk w 140 cms order the plate cable-channel w 120 cms ART.759

PROSPETTO INFORMATIVO  
information sheet

L w	VASCHETTA cable channel	UTILIZZABILE SU PIANI usable on the desk tops
L.80	ART.756	L.100-125
L.100	ART.757	L.120-145
L.120	ART.759	L.140
L.140	ART.760	L.160

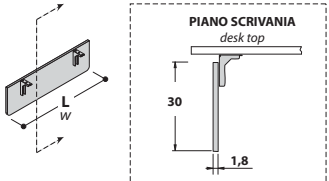
MODESTY PANELS							
modesty panels							
DESCRIZIONE description	L w	CODICE code	KG	M <sup>3</sup>	COLLI	PREZZO price	(*) CODICE FINITURA (* finish code)
MODESTY PANEL CON STAFFE IN DOTAZIONE modesty panel with stirrups  <p>L.x p.1,8 x H.30 width x d ¾" x h 1 1/4"</p>	MELAMINICO melamine						
	L. 80	154 621 (*)	5	0,007	2	€ 54,00	
	L.100	154 622 (*)	6	0,008	2	€ 57,00	
	L.120	154 623 (*)	6	0,009	2	€ 60,00	
	L.140	154 625 (*)	8	0,010	2	€ 66,00	
							MELAMINICO / melamine (*) PANNELLO panel 400 BIANCO BR. br. white

SCHEMA DI UTILIZZO MODESTY PANELS  
scheme of using modesty panels

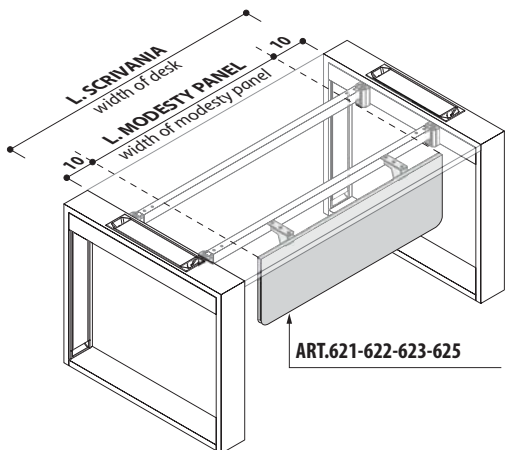

ART.621-622-623-625

**ESEMPIO: SU UNA SCRIVANIA L.140  
ORDINARE IL MODESTY L.120 ART.623**  
example: on the desk w 140 cms  
order the modesty panel w 120 cms ART.623

LARGHEZZA MODESTY PANELS width of modesty panels	UTILIZZABILE SU PIANI SCRIVANIE usable on the desk tops
L.80	ART.621 L.100
L.100	ART.622 L.120-125
L.120	ART.623 L.140-145
L.140	ART.625 L.160

LOGIC

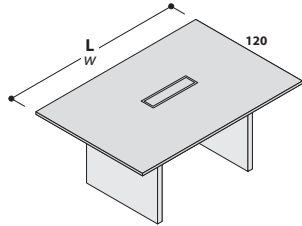
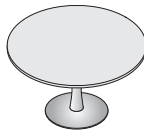
TAVOLI RIUNIONE							PIANI sp. 25mm tops thick. 25mm
meeting tables							
DESCRIZIONE description	L w	CODICE code	KG	M <sup>3</sup>	COLLI	PREZZO price	(*) CODICE FINITURA (* finish code)
TAVOLO RIUNIONE RETTANGOLARE rectangular meeting table  <p>L.x p.120 x H.72</p>	CON PASSACAVO with wire-manager						
	L.180	154 598 (*)	76	0,221	4	€ 531,00	
	L.240	154 599 (*)	94	0,248	4	€ 600,00	
TAVOLO RIUNIONE CIRCOLARE Ø 120 rounded meeting table Ø 120 cms  <p>Ø 120 x H.72</p>							
	Ø120	154 473 (*)	39	0,158	3	€ 414,00	
							(*) PIANO BORDO E BASAMENTO top edge and base 400 BIANCO BR. BIANCO BR. br. white br. white 403 ROVERE BIANCO BR. oak br. white 466 NOCE PAVIA BIANCO BR. pavia walnut br. white



# LOGIC

## DESCRIZIONE TECNICA

### PIANI

Disponibili con forma lineare o workstation.

Realizzati con pannelli di particelle di legno sp. mm 25 nobilitati in melaminico, disponibili nei colori: ROVERE 03, NOCE PAVIA 06, BIANCO BR. 69.

I bordi perimetrali sono in ABS sp. mm 2 in abbinamento alle strutture BIANCO BR. 69.

L'assemblaggio con le strutture avviene utilizzando viti passo metrico su bussole pre-montate.

Tutti i piani sono dotati di travi metalliche portanti, con supporti stampati con cava a coda di rondine con viti passo metrico su bussole pre-montate ai fianchi legno o gambe metalliche.

### FIANCHI LEGNO

Disponibili per piani con profondità cm 55, 80 e 116 ( per 2 piani da cm 55 accoppiati).

Realizzati con pannelli di particelle di legno sp. mm 50 nobilitati in melaminico, disponibili nel colore BIANCO BR. 69.

Sono rifiniti perimetralmente con bordo in ABS sp. mm 2 in tinta con la superficie. Sono disponibili in 2 versioni: terminali o centrali a seconda della posizione che assumono rispetto al piano. I fianchi centrali sono dotati di fori passa-cavi per eventuale passaggio elettrificazione. Tutti i fianchi sono dotati di piedini livellatori e sono predisposti per l'aggancio delle travi portanti.

### GAMBE METALLICHE

Con funzione di Wire Management dotata di canalina di salita cavi a 3 vie con copertura e passacavo

Gambe realizzate in lamiera metallica sp. 1.2 mm verniciata a polveri epossidiche nel colore BIANCO BR. (BI 01).

Il collegamento alle travi di irrigidimento trasversali avviene con sistema di aggancio costituito da supporti stampati con cava a coda di rondine fissati tramite viti passo metrico.

Sono disponibili in 2 versioni: terminali o centrali a seconda della posizione che assumono rispetto al piano. Tutte le gambe metalliche sono dotate di piedini livellatori in nylon stampato.

### PASSACAVO

Realizzato in tecnopolimero stampato nel colore BIANCO BR.

Consente l'alloggiamento di prese Schuko e RJ all'interno del traverso della gamba ed il fissaggio dei sostegni per schermi in metacrilato.

### ALLUNGHI, PORTA-CPU, MOBILI PORTANTI, STORAGE H. cm 112.

Strutture realizzate con pannelli di particelle di legno sp. mm 25 e 18, nobilitati in melaminico, disponibili nel colore BIANCO BR. 69.

I pannelli sp. mm 25 hanno i bordi perimetrali in ABS sp. mm 2 in tinta con la superficie, i pannelli sp. mm 18 hanno i bordi in melaminico sp. 0,4 anch'essi in tinta con la superficie.

Tutti i fianchi delle strutture sono predisposti per l'aggancio delle travi portanti dei piani scrivania. I cassetti in legno sono dotati di serratura centralizzata, le spondine sono in fibre legnose sp. mm 12 rivestite in PVC nero, il fondo è in fibra dello spessore di mm 3.

Le guide scorrevoli sono del tipo in metallo con cuscinetti in nylon dotati di fine corsa in estrazione e self-closing in chiusura.

La maniglia, ad incasso, è realizzata da disegno esclusivo in ABS; disponibile nei colori in abbinamento con la carcassa BIANCO BR. 69.

I cassetti estraibili, con maniglione verticale in tubolare di ferro mm 12x12 verniciato, hanno una struttura interna in lamiera metallica e nella parte superiore una vaschetta porta-cancelleria.

Le ante legno sono realizzate con pannelli di particelle di legno sp. mm 18 disponibili nello stesso colore della struttura BIANCO BR. 69. Sono rifinite perimetralmente con bordo in ABS sp. mm 2 in tinta con la superficie. Le ante legno sono dotate di serratura. Tutti gli allunghi, porta-CPU, mobili portanti, muri attrezzati e contenitori h.cm 112 sono dotati di piedini livellatori di colore nero.

### PANNELLI FRONTALI

Realizzati con pannelli di particelle di legno sp. mm 12, nobilitati in melaminico, disponibili nel colore BIANCO BR. 69.

Rifiniti perimetralmente con bordo in ABS sp. mm 2 in tinta con la superficie.

Si assemblano alle scrivanie tramite staffe metalliche di colore BIANCO BR. 69.

### SCHERMI DIVISORI IN METACRILATO

Realizzati con lastre di sp. mm 4 nel colore BIANCO.

Disponibili in 2 versioni: la prima per il montaggio su gambe metalliche a cornice, la seconda per il montaggio su spazi a giorno degli storage. Vengono forniti con ferramenta di colore alluminio "0" chimico, idonea all'assemblaggio degli stessi.

### MODESTY PANEL

Realizzati con pannelli di particelle di legno sp. mm 18, nobilitati in melaminico, disponibili nel colore: BIANCO BR. 69.

Sono rifiniti perimetralmente con bordo in ABS sp. mm 2 in tinta con la superficie. Si assemblano alle scrivanie tramite staffe metalliche di colore BIANCO.

### CASSETTIERE SU RUOTE

Struttura realizzata con pannelli di particelle legno sp. mm 18 nobilitati in melaminico, disponibile nei colore BIANCO BR. 69 rifinita perimetralmente con bordo melaminico mm 0,4.

I frontali sono realizzati con pannello di particelle di legno sp. mm 18 nobilitato melaminico e disponibili nei colori: ROVERE 03, NOCE PAVIA 06, BIANCO BR. 69. I bordi perimetrali sono in ABS mm 2 in tinta con la superficie.

I cassetti in legno sono dotati di serratura centralizzata, le spondine sono in fibre legnose sp. mm 12 rivestite in PVC nero, il fondo è in fibra dello spessore di mm 3.

Le guide scorrevoli sono del tipo in metallo con cuscinetti in nylon dotati di fine corsa in estrazione e self-closing in chiusura.

La maniglia, ad incasso, è realizzata da disegno esclusivo in ABS; disponibile nei colori in abbinamento con la carcassa BIANCO BR. 69.

Le cassettiere poggiano su ruote piroettanti, ad innesto rapido, di colore grigio.

**TAVOLO RIUNIONE CON FIANCHI LEGNO**

-Piano realizzato con pannello di particelle di legno sp. mm 25 nobilitato in melaminico, disponibili nei colori: ROVERE 03, NOCE PAVIA 06, BIANCO BR. 69.

I bordi perimetrali sono in ABS sp. mm 2 in abbinamento ai fianchi BIANCO BR. 69. L'assemblaggio con le strutture avviene utilizzando viti passo metrico su bussole pre-montate.

Il piano è dotato di travi metalliche portanti, con supporti stampati con cava a coda di rondine con viti passo metrico su bussole pre-montate ai fianchi legno. Sul piano è inserito un top access integrato, con cornice in profilato di alluminio estruso anodizzato, coperchio con apertura a ribalta e spazzolino parapolvere nero.

-Fianchi realizzati con pannelli di particelle di legno sp. mm 50 nobilitati in melaminico, disponibili nel colore BIANCO BR. 69.

Sono rifiniti perimetralmente con bordo in ABS sp. mm 2 in tinta con la superficie, sono dotati di piedini livellatori e sono predisposti per l'aggancio delle travi portanti.

**TAVOLO RIUNIONE CON BASAMENTO A COLONNA**

-Piano realizzato con pannello di particelle di legno sp. mm 25 nobilitato in melaminico, disponibili nei colori: ROVERE 03, NOCE PAVIA 06, BIANCO BR. 69. I bordi perimetrali sono in ABS sp. mm 2 colore bianco.

L'assemblaggio con il basamento avviene utilizzando viti passo metrico su bussole pre-montate.

-Basamento metallico composto da: base circolare Ø590mm, tubo verticale e crociera superiore.

Il tubo verticale ha una sezione che parte alla base con un Ø128mm e poi sale a un Ø 89mm. La crociera è realizzata con lamiera metallica sp. mm 4 dotata di asole per il fissaggio sottopiano. Il basamento è verniciato a polveri epossidiche BIANCO BR. (BI 01).

**IMBALLO**

Tutti i componenti sono forniti smontati ed imballati con involucro pieghevole in cartone triplo, listelli di protezione perimetrale e per i riempimenti ove occorre. Gli angoli sono protetti, ove occorre, con parasigoli anti-urto. La chiusura dell'imbollo avviene mediante nastro adesivo e reggetta in nylon termosaldato.

Le cassettiere sono fornite montate, protette sui lati con angolari in polistirolo ed imballate con foglia di polietilene termoretraibile.

CARATTERISTICHE FISICO-MECCANICHE DEI PANNELLI DI PARTICELLE DI LEGNO DI SPESSORE mm 18 NOBILITATI IN MELAMINICO:		
DESCRIZIONE	VALORE MINIMO	NORMA DI RIFERIMENTO
Massa volumica	650 Kg / m <sup>3</sup> ± 10%	UNI EN 323 :1994
Umidità relativa	5 - 13%	UNI EN 322 :1994
Tolleranza spessore	± 0,3 mm	UNI EN 324-1/1994
Rigonfiamento a 24 ore	15%	UNI EN 317 :1994
Distacco strati esterni	0,8 Mpa	UNI EN 311 :2003
Flessione statica	16 Mpa	UNI EN 310 :1994
Modulo di elasticità	1600 Mpa	UNI EN 310 :1994
Estrazione viti sui bordi	> 400 N	UNI EN 320 :1994
Contenuto di formaldeide	≤ a 3,5 mg H <sub>2</sub> CO (m <sup>2</sup> x h)	UNI EN ISO 12460 - 3:2015

Emesso da Ufficio Tecnico  
LAS MOBILI  
Data ultima revisione:  
GENNAIO 2018

## TECHNICAL DESCRIPTIONS

### SURFACES

Available in linear form or workstation.

Made with 25 mm particleboard panels, melamine-faced, available in: OAK 03, PAVIA WALNUT 06, BR. WHITE 69. The perimeter shaped borders are in 2 mm ABS BR. WHITE 69 colour matching the frame.

The structure assembly takes place using metric step screws on pre-mounted compasses.

All surfaces are equipped with metallic support beams, with dovetail pit printed supports with metric step screws on pre-mounted compasses at the wooden sides or metallic legs.

### WOODEN SIDE PANELS

Available for 55,80 cm and 116 cm deep surfaces (for 2 matching 55cm surfaces).

Made with 50 mm particleboard panels, melamine-faced, available in BR. WHITE 69.

They are perimeter refined with 2 mm ABS edge colour matching the surface. Available in 2 versions: end or central depending on their position in respect to the surface. The central sides are equipped with cable passages holes for eventual electrification passage.

All sides are equipped with levelling feet and are pre-arranged for hooking supporting beams.

### METALLIC LEGS

The metallic legs are with Wire Management function equipped with cable ascent 3 way passage with covering

Legs made with 1,2 mm metallic sheet painted with epoxy resin powder in BR. WHITE (BI 01).

The transversal tightening connection to the beams is carried out through a hooking system constituted of dovetail pit printed supports fixed with metric step screws.

Available in 2 versions: end or central depending on the position they assume in respect to the surface. All the metallic legs are equipped with levelling feet in printed nylon.

### WIRE MANAGEMENT

Made in techno-polymer in BR. WHITE 69 colour.

Allows the lodging of the Schuko and RJ plugs inside the leg transverse and the fixing of the supports for methacrylate screens.

### EXTENSIONS, CPU-HOLDER, SUPPORTING FURNITURE, STORAGE 112 CM HIGH

Structures made with 25 mm and 18 mm particleboard panels, melamine-faced, available in BR. WHITE 69 colour.

The 25 mm panels have 2 mm ABS perimeter borders colour matching the surface, the 18 mm panels have 0,4 mm melamine borders, also colour matching the surface.

All the structures sides are pre-arranged for hooking the supporting beams of the desk surfaces. The wooden drawers are equipped with centralised lock, the edges are in 12 mm wooden fibres covered in black PVC, the bottom is in 3 mm fibre.

The sliding guides are in metal with nylon cushions equipped with end run extraction and self-closing closure.

The integrated handle is made from an exclusive ABS design, also available in BR. WHITE 69 matching the frame.

The extractable drawers, with vertical 12x12 painted iron tubular handle, have an internal structure in metallic sheet and in the upper part a stationary tray.

The wooden doors are made with 18 mm particleboard panels the same colour as the structures : BR. WHITE 69. They are perimeter refined with 2 mm ABS edge colour matching the surface. The wooden doors are equipped with lock.

All the extensions, CPU-holder, supporting furniture, storage and 112 cm high cabinets are equipped with black levelling feet.

### FRONT PANELS

Available in melamine-faced version. Are made with 12 mm particleboard panels, melamine-faced, available in BR. WHITE 69 colour.

Perimeter refined with 2 mm ABS edge colour matching the surface.

They are assembled to the desks using BR. WHITE 69 metallic stirrups.

### METHACRYLATE DIVIDING SCREENS

Made with 4 mm sheet in WHITE colour.

Available in 2 versions: the first for the assembling on metallic legs with frame, the second for the assembling on empty spaces on storage. They are equipped with hardware chemical "0" aluminium colour, ideal for assembling the same.

### MODESTY PANEL

Made with 18 mm particleboard panels, melamine-faced, available in BR. WHITE 69 colour. They are perimeter refined with 2 mm ABS edge colour matching the surface. They are assembled to the desks using WHITE metallic stirrups.

### PEDESTALS ON WHEELS

Structure made with 18 mm wooden particle panels, melamine-faced, available in BR. WHITE 69 colour, perimeter refined with 0,4 mm edge.

The frontals are made with 18 mm wooden particle panels, melamine-faced and available in colours: OAK 03, PAVIA WALNUT 06, BR. WHITE 69. The perimeter edges are in 2 mm ABS colour matching the surface.

The wooden drawers are equipped with centralised lock, 12 mm wooden fibre sides covered in black PVC, the bottom is in 3 mm fibre.

The sliding guides are in metal with nylon cushions equipped with end run extraction and self-closing closure.

The integrated handle is made from an exclusive ABS design, also available in BR. WHITE 69 in matching the frame.

The drawers rest upon grey quick clutch twisting wheels.

**MEETING TABLE WITH WOODEN BASE**

-Top made with 25 mm particleboard panel, melamine-faced, available in: OAK 03, PAVIA WALNUT 06, BR. WHITE 69. The perimeter shaped borders are in 2 mm ABS BR. WHITE 69 colour matching the side panels.  
 The structure assembly takes places using metric step screws on pre-mounted compasses.  
 The top is equipped with metallic support beams, with dovetail pit printed supports with metric step screws on pre-mounted compasses at the wooden sides. On the table is inserted a Top Access made of anodised extruded aluminium, equipped with flap opening door and black dust seal brush.  
 -Wooden side panels made with 50 mm particleboard panels, melamine-faced, available in BR. WHITE 69 colour.  
 They are perimeter refined with 2 mm ABS edge colour matching the surface. All sides are equipped with levelling feet and are pre-arranged for hooking supporting beams.

**CIRCULAR MEETING TABLE WITH COLUMN BASE**

Composed of: top and column base.  
 -Top made with 25 mm particleboard panel, melamine-faced, available in colours: OAK 03, PAVIA WALNUT 06, BR. WHITE 69. The perimeter shaped borders are in 2 mm ABS BR. WHITE 69 colour matching the base.  
 The structure assembly takes places using metric step screws on pre-mounted compasses.  
 - Metal base composed of: circular base Ø590mm, vertical column and upper plate.  
 The column is made with a tube that has a section that starts at the base with a Ø128mm and then rises to a Ø 89mm. The top plate is made of sheet metal sp. 4 mm with holes for fixing undertop. The metal base is painted with epoxy powder in the colour BR. WHITE (BI 01).

**PACKAGING**

All the components are disassembled and packed when supplied, and have paper triple type folding packaging, fillets for the perimetrical protection and for the fillings up, where needed . The corners are protected, where needed, through shock resistant edges protector. The packing closure occurs through sticky tape and welded nylon strap.  
 Pedestals are assembled, when supplied, protected through polystyrene angle bars on the sides and packed using thermo-retractable polyethylene leave when provided.

PHYSICAL-MECHANICAL CHARACTERISTICS OF 18 MM THICK PARTICLEBOARD PANELS, MELAMINE-FACED:		
DESCRIPTION	MINIMUM VALUE	STANDARD NUMBERS
Volume Mass	650 Kg / m <sup>3</sup> ± 10%	UNI EN 323 :1994
Relative Humidity	5 - 13%	UNI EN 322 :1994
Thickness Allowance	± 0,3 mm	UNI EN 324-1/1994
24 hour Swelling	15%	UNI EN 317 :1994
External Surfaces Detachment	0,8 Mpa	UNI EN 311 :2003
Static Flexure	16 Mpa	UNI EN 310 :1994
Elastic Modulus	1600 Mpa	UNI EN 310 :1994
Edge Screws Extraction	> 400 N	UNI EN 320 :1994
Formaldehyde Content	≤ a 3,5 mg H <sub>2</sub> CO (m <sup>2</sup> x h)	UNI EN ISO 12460 - 3:2015

Released by the Technical Office  
 of LAS MOBILI  
 last revision date:  
 JANUARY 2018

**INDICE DEI CODICI**  
*codes index*

\* = INDICARE IL CODICE FINITURA  
 = complete with finish code

INDICE DEI CODICI / codes index  
 Mod. LOGIC

CODICE code	DESCRIZIONE description	PAG. page	PREZZO price
114 <b>956</b> *	CUSCINO PER CASSETTIERE SU RUOTE CAT.F cushion for pedestals on wheels CAT.F.	15	€ 51,00
154 <b>453</b> *	PIANO SCRIVANIA LINEARE L.100 x p.80 linear desk top w 100 x d 80 cms	10	€ 146,00
154 <b>454</b> *	PIANO SCRIVANIA LINEARE L.120 x p.80 linear desk top w 120 x d 80 cms	10	€ 165,00
154 <b>455</b> *	PIANO SCRIVANIA LINEARE L.140 x p.80 linear desk top w 140 x d 80 cms	10	€ 180,00
154 <b>456</b> *	PIANO SCRIVANIA LINEARE L.160 x p.80 linear desk top w 160 x d 80 cms	10	€ 208,00
154 <b>461</b> *	PIANO SCRIVANIA DELTA L.100 x p.55/80 DX right delta desk top w 100 xd 55/80 cms	10	€ 133,00
154 <b>463</b> *	PIANO SCRIVANIA DELTA L.140 x p.55/80 DX right delta desk top w 140 xd 55/80 cms	10	€ 164,00
154 <b>466</b> *	PIANO SCRIVANIA DELTA L.100 x p.55/80 SX left delta desk top w 100 xd 55/80 cms	10	€ 133,00
154 <b>468</b> *	PIANO SCRIVANIA DELTA L.140 x p.55/80 SX left delta desk top w 140 xd 55/80 cms	10	€ 164,00
154 <b>470</b> *	PIANO SCRIVANIA LINEARE SAGOMATA L.140 x p.80 shaped linear desk top w 140 x d 80 cms	10	€ 199,00
154 <b>471</b> *	PIANO SCRIVANIA LINEARE SAGOMATA L.160 x p.80 shaped linear desk top w 160 x d 80 cms	10	€ 226,00
154 <b>472</b> *	PIANO WORKSTATION 120° workstation top 120°	10	€ 286,00
154 <b>473</b> *	TAVOLO RIUNIONE CIRCOLARE Ø 120 CM rounded meeting table Ø 120 cms	25	€ 414,00
154 <b>476</b> *	PIANO WORKSTATION L.125 x p.125 workstation top w 125 x d 125 cms	10	€ 289,00
154 <b>477</b> *	PIANO WORKSTATION L.145 x p.145 workstation top w 145 x d 145 cms	10	€ 331,00
154 <b>485</b> *	PIANO WORKSTATION L.125 x p.125 workstation top w 125 x d 125 cms	15	€ 219,00
154 <b>491</b> *	FIANCO TERMINALE DX O SX (PROF. CM 55) right or left terminal side panel (deep 55 cms)	12	€ 57,00
154 <b>493</b> *	FIANCO TERMINALE DX O SX (PROF. CM 80) right or left terminal side panel (deep 80 cms)	12	€ 76,00
154 <b>495</b> *	FIANCO TERMINALE DX O SX (PROF. CM 116) right or left terminal side panel (deep 116 cms)	12	€ 101,00
154 <b>501</b> *	GAMBA TEMINALE DX O SX (PROF. CM 80) CON PASSACAVO right or left terminal leg (deep 80 cms) with wire managements	12	€ 152,00
154 <b>504</b> *	GAMBA CENTRALE (PROF. CM 80) CON PASSACAVO central leg (deep 80 cms) with wire managements	12	€ 156,00
154 <b>509</b> *	GAMBA TEMINALE DX O SX (PROF. CM 116) CON PASSACAVO right or left terminal leg (deep 116 cms) with wire managements	12	€ 197,00
154 <b>526</b> *	MOBILE PORTANTE 4 CASSETTI + SERR. PER SCRIVANIE PROF. CM 55 (CON CHIUSURA AMMORTIZZATA) support cabinet with 4 drawers + lock for desks deep 55 cms (with soft-close)	14	€ 378,00
154 <b>529</b> *	MOBILE PORTANTE 4 CASSETTI + SERR. PER SCRIVANIE PROF. CM 80 (CON CHIUSURA AMMORTIZZATA) support cabinet with 4 drawers + lock for desks deep 80 cms (with soft-close)	14	€ 467,00
154 <b>570</b> *	MOBILE PORTANTE CON CASSETTO ESTRAIBILE L.35 + SERR. PER SCRIVANIE PROF. CM 80 support cabinet with pull-out drawer w 35 cms + lock for desks deep 80 cms	14	€ 495,00
154 <b>578</b> *	STORAGE L.185 AGGREGABILE A SCRIVANIE PROF. CM 55-80 storage w 185 cms for desk tops deep 55-80 cms	16	€ 411,00
154 <b>584</b> *	STORAGE L.160 AGGREGABILE A SCRIVANIE PROF. CM 80 storage w 160 cms for desk tops deep 80 cms	16	€ 741,00
154 <b>585</b> *	STORAGE L.80 AGGREGABILE A SCRIVANIE PROF. CM 80 storage w 80 cms for desk tops deep 80 cms	16	€ 199,00
154 <b>586</b> *	STORAGE L.80 CON 2 ANTE LEGNO BASSE + SERR. storage w 80 cms with 2 low wooden doors + lock	16	€ 279,00
154 <b>590</b> *	ALLUNGO TERMINALE O CENTRALE L.35 x p.150 terminal or central extension w 35 x d 150 cms	13	€ 257,00
154 <b>592</b> *	PORTA-CPU TERMINALE O CENTRALE (PROF. CM 55) terminal or central CPU-holder (deep 55 cms)	13	€ 146,00
154 <b>593</b> *	PORTA-CPU TERMINALE O CENTRALE (PROF. CM 80) terminal or central CPU-holder (deep 80 cms)	13	€ 180,00
154 <b>594</b> *	PORTA-CPU TERMINALE O CENTRALE (PROF. CM 116) terminal or central CPU-holder (deep 116 cms)	13	€ 252,00
154 <b>598</b> *	TAVOLO RIUNIONE RETTANGOLARE L.180 rectangular meeting table w 180 cms	25	€ 531,00
154 <b>599</b> *	TAVOLO RIUNIONE RETTANGOLARE L.240 rectangular meeting table w 240 cms	25	€ 600,00
154 <b>600</b> *	SCHERMO DIVISORIO LATERALE L.50 IN METACRILATO methacrylate side dividing screen w 50	23	€ 90,00
154 <b>601</b> *	SCHERMO DIVISORIO LATERALE L.65 IN METACRILATO methacrylate side dividing screen w 65	23	€ 95,00
154 <b>605</b> *	SCHERMO DIVISORIO L.43,5 IN METACRILATO PER STORAGE methacrylate dividing screen w 43,5 cms for storage	17	€ 102,00
154 <b>607</b> *	SCHERMO DIVISORIO L.68,5 IN METACRILATO PER STORAGE methacrylate dividing screen w 68,5 cms for storage	17	€ 129,00
154 <b>615</b> *	STAFFA L.50 PER ATTACCO PIANO A STORAGE stirrup w 50 cms for desk tops with connection at storage	17	€ 23,00
154 <b>616</b> *	STAFFA L.75 PER ATTACCO PIANO A STORAGE stirrup w 75 cms for desk tops with connection at storage	17	€ 32,00
154 <b>617</b> *	STAFFA L.77,5 PER ATTACCO PIANO A STORAGE stirrup w 77,5 cms for desk tops with connection at storage	17	€ 34,00
154 <b>621</b> *	MODESTY PANEL L.80 (CON STAFFE IN DOTAZIONE) modesty panel w 80 cms (with stirrups)	25	€ 54,00
154 <b>622</b> *	MODESTY PANEL L.100 (CON STAFFE IN DOTAZIONE) modesty panel w 100 cms (with stirrups)	25	€ 57,00



\* = INDICARE IL CODICE FINITURA  
= complete with finish code

INDICE DEI CODICI / codes index  
Mod. LOGIC

CODICE code	DESCRIZIONE description	PAG. page	PREZZO price
154 <b>623</b> *	MODESTY PANEL L.120 (CON STAFFE IN DOTAZIONE) modesty panel w 120 cms (with stirrups)	25	€ 60,00
154 <b>625</b> *	MODESTY PANEL L.140 (CON STAFFE IN DOTAZIONE) modesty panel w 140 cms (with stirrups)	25	€ 66,00
154 <b>675</b> *	CASSETTIERA SU RUOTE 3 CASSETTI + SERR. (CON CHIUSURA AMMORTIZZATA) Pedestal on wheels 3 drawers + lock (with soft-close)	15	€ 228,00
154 <b>677</b> *	CASSETTIERA-CLASSIFICATORE SU RUOTE + SERR. (CON CHIUSURA AMMORTIZZATA) pedestal on wheels with file-drawer + lock (with soft-close)	15	€ 251,00
154 <b>711</b> *	PANNELLO FRONTALE L.80 (MELAMINICO CON STAFFE IN DOTAZIONE) front panel w 80 cms (melamine with stirrups)	23	€ 69,00
154 <b>712</b> *	PANNELLO FRONTALE L.100 (MELAMINICO CON STAFFE IN DOTAZIONE) front panel w 100 cms (melamine with stirrups)	23	€ 76,00
154 <b>713</b> *	PANNELLO FRONTALE L.120 (MELAMINICO CON STAFFE IN DOTAZIONE) front panel w 120 cms (melamina with stirrups)	23	€ 84,00
154 <b>715</b> *	PANNELLO FRONTALE L.140 (MELAMINICO CON STAFFE IN DOTAZIONE) front panel w 140 cms (melamine with stirrups)	23	€ 87,00
154 <b>732</b> *	PORTA-CARTA L.50 x p.30 paper-holder w 50 x d.30 cms	24	€ 64,00
154 <b>733</b> *	PORTA-CARTA L.65 x p.30 paper-holder w 65 x d.30 cms	24	€ 67,00
154 <b>737</b> *	PORTA-PENNE L.9 pen-holder w 9 cms	24	€ 19,00
154 <b>738</b> *	PORTA-PENNE L.18 pen-holder w 18 cms	24	€ 22,00
154 <b>739</b> *	PORTA-CARTA paper-holder	24	€ 31,00
154 <b>740</b> *	LAVAGNA METALLICA metallic whiteboard	24	€ 28,00
154 <b>756</b> *	VASCHETTA PASSA-CAVI L.80 plate cable-channel w 80 cms	24	€ 22,00
154 <b>757</b> *	VASCHETTA PASSA-CAVI L.100 plate cable-channel w 100 cms	24	€ 28,00
154 <b>759</b> *	VASCHETTA PASSA-CAVI L.120 plate cable-channel w 120 cms	24	€ 30,00
154 <b>760</b> *	VASCHETTA PASSA-CAVI L.140 plate cable-channel w 140 cms	24	€ 32,00

LOGIC





LISTINO 2018  
PRICE LIST

# CONTENITORI UNIVERSALI EVO universal cabinets

Design -Engineering  
C.S.R. LAS MOBILI

**QUESTA SERIE DI CONTENITORI UNIVERSALI EVO E' STATA CREATA PER ESSERE INTEGRATA  
CON TUTTA LA GAMMA PRODOTTI LAS MOBILI,  
GRAZIE AI COLORI CHE PERMETTONO QUALSIASI ABBINAMENTO**  
*this range of universal cabinets EVO has been made to be combined with all LAS MOBILI product, thanks to  
the colours that allow any matching*

CONTENITORI  
UNIVERSALI EVO  
universal cabinets evo



## IMPORTANTE / it's very important

SULL'ORDINE INDICARE SEMPRE IL CODICE COMPLETO A 9 CIFRE  
always indicate on the order the complete 9-digit code

ESEMPIO: PER ORDINARE 1 MOBILE **ART.800** NOCE PAVIA INDICARE IL CODICE =  
example: to order 1 CABINET **ART.800** PAVIA WALNUT indicate the code =

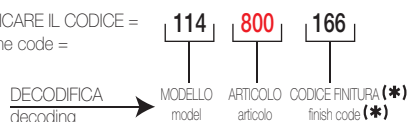

In vigore dal:  
Valid from:  
01/01/2018

Valido fino a nuova emissione  
Valid until new emission

**CERTIFICAZIONI DISPONIBILI / available certifications****MATERIALI E FINITURE / materials and finishes**

NORMA DI RIFERIMENTO standard norms	DESCRIZIONE NORMA	norm descriptions
UNI EN 13721:2004	Riflettanza della superficie.	Reflection factor of the surface.
UNI EN 13722:2004	Riflessione speculare della superficie	Measurement of specular gloss of the surface.
UNI EN ISO 12460 - 3:2015	Rilascio di formaldeide. Gas analisi, prova singola.	Formaldehyde release.
UNI 10460:1995	Determinazione della resistenza dei bordi all'acqua.	Water resistance of the edges.
UNI 9242:1987 + UNI 9242:1987/A1/98	Determinazione della resistenza dei bordi al calore.	Determination of heat resistance of the edges.

**MOBILI CONTENITORI / storage furniture**

NORMA DI RIFERIMENTO standard norms	DESCRIZIONE NORMA	norm descriptions
UNI 8601:1984	Prova di flessione dei piani.	Test for flexural strength of the shelves.
UNI 8606:1984	Prova di carico totale massimo.	Maximum load test.
UNI EN 16122:2012 +EC1 2013	Prova di resistenza del fondo dei cassetti.	Test for strength of bottom of the drawers.
UNI EN 14073-2:2005 Par. 3.4	Par. 3.4 Requisito generale di sicurezza.	Par. 3.4 General safety requirement.
UNI EN 14073-3:2005 Par. 5.2	Par. 5.2 Resistenza del mobile.	Par. 5.2 Strength of the cabinet structure.
UNI EN 14073-3:2005 Par. 5.3.1	Par. 5.3.1 Estrazione dei ripiani.	Par. 5.3.1 Extraction of the shelves.
UNI EN 14073-3:2005 Par. 5.3.2	Par. 5.3.2 Resistenza dei supporti dei ripiani.	Par. 5.3.2 Strength of the shelves supports.
UNI EN 14073-3:2005 Par. 5.4	Par. 5.4 Resistenza dei piani di copertura.	Par. 5.4 Strength of the tops.
UNI EN 14073-3:2005 Par. 5.5	Par. 5.5 Stabilità dei mobili indipendenti.	Par. 5.5 Stability of single cabinet.
UNI EN 14074:2005 Par. 6.2.1	Par. 6.2.1 Resistenza degli elementi estensibili.	Par. 6.2.1 Strength of the stretchable elements.
UNI EN 14074:2005 Par. 6.2.2	Par. 6.2.2 Prova di durabilità degli elementi estensibili.	Par. 6.2.2 Duration of the stretchable elements.
UNI EN 14074:2005 Par. 6.2.3	Par. 6.2.3 Apertura con urto degli elementi estensibili.	Par. 6.2.3 Opening with crash of the stretchable elements.
UNI EN 14074:2005 Par. 6.3.1	Par. 6.3.1 Carico verticale sulle porte.	Par. 6.3.1 Load test of pivoted doors.
UNI EN 14074:2005 Par. 6.3.2	Par. 6.3.2 Forza statica orizzontale sulla porta aperta.	Par. 6.3.2 Horizontal static force on open door.
UNI EN 14074:2005 Par. 6.3.3	Par. 6.3.3 Prova di durabilità delle porte con cerniera e ad asse verticale.	Par. 6.3.3 Duration of the doors with hinge and vertical axle.
UNI EN 14074:2005 Par. 6.7	Par. 6.7 Prova di rotolamento per cassettiere su ruote.	Par. 6.7 Rolling test for pedestals on wheels.

ULTIMA REVISIONE: GENNAIO 2018  
latest revision: JANUARY 2018

Per eventuali aggiornamenti più recenti  
le **CERTIFICAZIONI** e i **LISTINI** sono disponibili su Internet:  
For latest updatings  
the **CERTIFICATIONS** and **PRICE LIST** are available on Internet:

- 1-  [www.las.it](http://www.las.it)
- 2- **AREA RISERVATA RIVENDITORE**  
Dealer's private area
- 3- **SCARICA DOCUMENTI IN FORMATO .PDF**  
Downloads .PDF files



<b>ABACO ALTEZZE E CONFIGURAZIONI MOBILI CONTENITORI</b> .....	<b>4</b>
<i>abacus of height and configuration of cabinets</i>	
<b>CARTELLA COLORI</b> .....	<b>6</b>
<i>colours samples card</i>	
<b>ABBINAMENTI COLORI</b> .....	<b>7</b>
<i>matching colours</i>	
<b>CASSETTIERE SU RUOTE</b> .....	<b>8</b>
<i>pedestals on wheels</i>	
<b>ACCESSORI PER CASSETTIERE</b> .....	<b>9</b>
<i>accessories for pedestals</i>	
<b>CUSCINI PER CASSETTIERE E MOBILI DI SERVIZIO</b> .....	<b>10</b>
<i>cushions for pedestals or service units</i>	
<b>MOBILI SU RUOTE</b> .....	<b>11</b>
<i>cabinets on wheels</i>	
<b>CONTENITORI MEDI H.119,8</b> .....	<b>14</b>
<i>medium cabinets h. 119,8 cms</i>	
<b>CONTENITORI MEDI H.158,3</b> .....	<b>16</b>
<i>medium cabinets h. 158,3 cms</i>	
<b>CONTENITORI ALTI H.196,7</b> .....	<b>18</b>
<i>high cabinets h. 196,7 cms</i>	
<b>CONTENITORI ALTI H.235</b> .....	<b>22</b>
<i>high cabinets h. 235 cms</i>	
<b>CONTENITORI ALTI H.260</b> .....	<b>26</b>
<i>high cabinets h. 260 cms</i>	
<b>CONTENITORI SENZA RIPIANI REGISTRABILI</b> .....	<b>28</b>
<i>cabinets <b>without adjustable shelves</b></i>	
<b>TOP DI FINITURA</b> .....	<b>30</b>
<i>finish top</i>	
<b>STRUTTURA METALLICA PER CONTENITORI BASSI, MEDI E ALTI</b> .....	<b>30</b>
<i>metallic structure for low, medium and high cabinets</i>	
<b>RIPIANI E CASSETTI CLASSIFICATORI PER CONTENITORI</b> .....	<b>31</b>
<i>adjustable shelves and file-drawers for cabinets</i>	
<b>COMPLEMENTI PER CONTENITORI</b> .....	<b>32</b>
<i>complements for cabinets</i>	
<b>KIT AMMORTIZZATORI (PER ANTE LEGNO)</b> .....	<b>38</b>
<i>dampers set (for wooden doors)</i>	
<b>KIT BASETTE CON CERNIERE APERTURA 175° (PER ANTE LEGNO)</b> .....	<b>38</b>
<i>set of cruciform metal plates with 175° opening hinges (for wooden doors)</i>	
<b>KIT MANIGLIE (PER ANTE LEGNO E CASSETTI)</b> .....	<b>39</b>
<i>set of handles (for wooden doors and drawers)</i>	
<b>ANTE VETRO TEMPERATO SATINATO CON TELAIO</b> .....	<b>40</b>
<i>tempered <b>satined</b> glass doors with metal frame</i>	
<b>ANTE IN VETRO TEMPERATO TRASPARENTE SENZA TELAIO</b> .....	<b>41</b>
<i>tempered transparent glass doors without metallic frame</i>	
<b>KIT CILINDRO SERRATURA PER CHIAVI UGUALI</b> .....	<b>42</b>
<i>cylinder lock kit for keys alike</i>	
<b>KIT FISSAGGIO A MURO</b> .....	<b>42</b>
<i>wall fixing kit</i>	
<b>KIT TAPPI COPRIFORI PER MOBILI</b> .....	<b>42</b>
<i>set of hole cover caps for cabinets</i>	
<b>CONTENITORI CON ANTE SCORREVOLI</b> .....	<b>43</b>
<i>cabinets with sliding doors</i>	
<b>LIBRERIE SPALLA UNICA H.235</b> .....	<b>44</b>
<i>bookcases with shared side panel h.235 cms</i>	
<b>LIBRERIE SPALLA UNICA H.270</b> .....	<b>45</b>
<i>bookcases with shared side panel h.270 cms</i>	
<b>ESEMPI DI AGGREGAZIONE LIBRERIE SPALLA UNICA</b> .....	<b>46</b>
<i>examples of connection bookcases with shared side panel</i>	
<b>BUSSOLOTTA PER LIBRERIE SPALLA UNICA</b> .....	<b>47</b>
<i>modular unit for bookcases with shared side panel</i>	
<b>MAGGIORAZIONI PER TAGLI A MISURA (RIDUZIONI DIMENSIONALI)</b> .....	<b>53</b>
<i>price increase for cuts to sizes (sizes reduction)</i>	
<b>DESCRIZIONE TECNICA</b> .....	<b>57</b>
<b>TECHNICAL DESCRIPTION</b> .....	<b>59</b>
<b>INDICE DEI CODICI</b> .....	<b>61</b>
<i>codes index</i>	

NEW

# ABACO ALTEZZE E CONFIGURAZIONI MOBILI CONTENITORI

*abacus of height and configuration of cabinets*

STRUTTURE METALLICHE PER  
 MOBILI FREESTANDING  
 metallic structure for  
 freestanding cabinets  
**H 81,5-119,8-158,3-196,7**

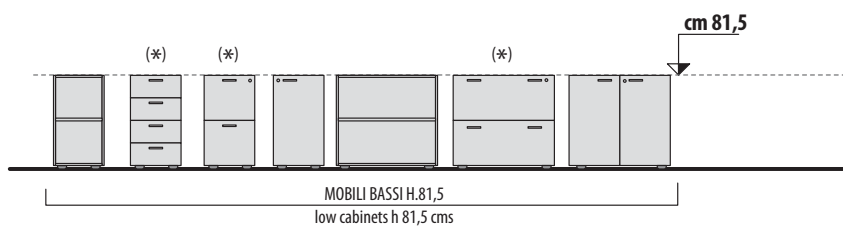

**NEW**

**LIBRERIE SPALLA UNICA**  
 bookcases with shared side panel

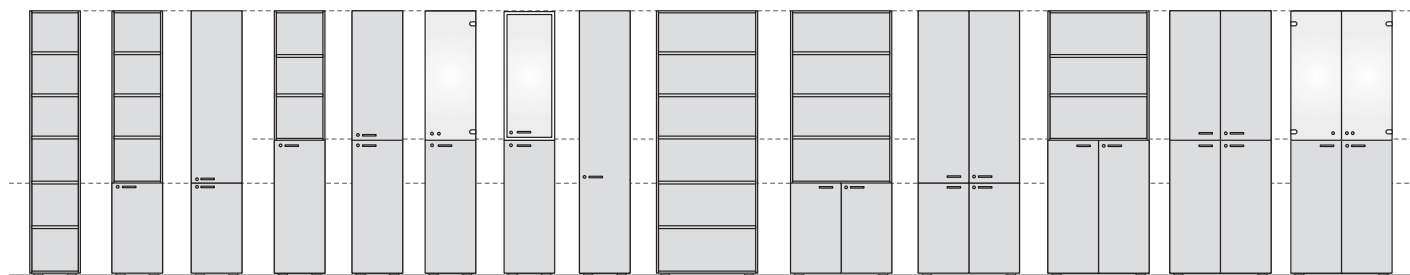
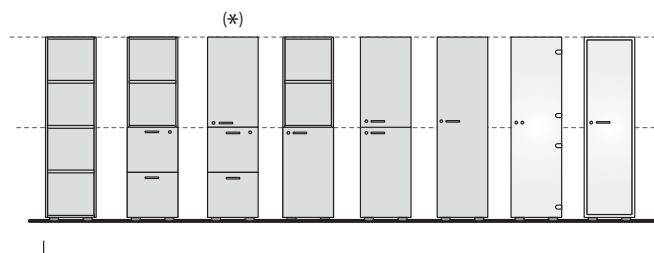
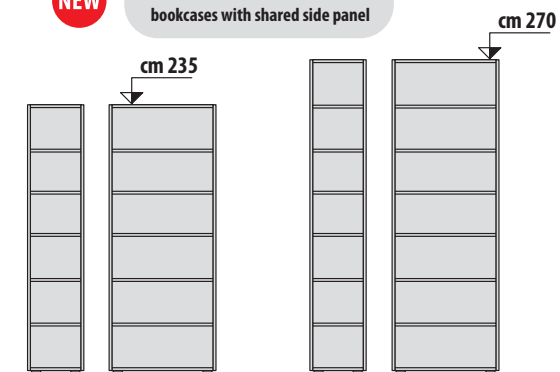

**MOBILI ALTI H.235 (kit fissaggio a muro incluso)**  
 high cabinets h 235 cms (wall fixing kit included)

(\*)=CONFIGURAZIONI NON POSSIBILI PER MOBILI PROF. CM 35  
 configurations don't availables for cabinets deep 35 cms

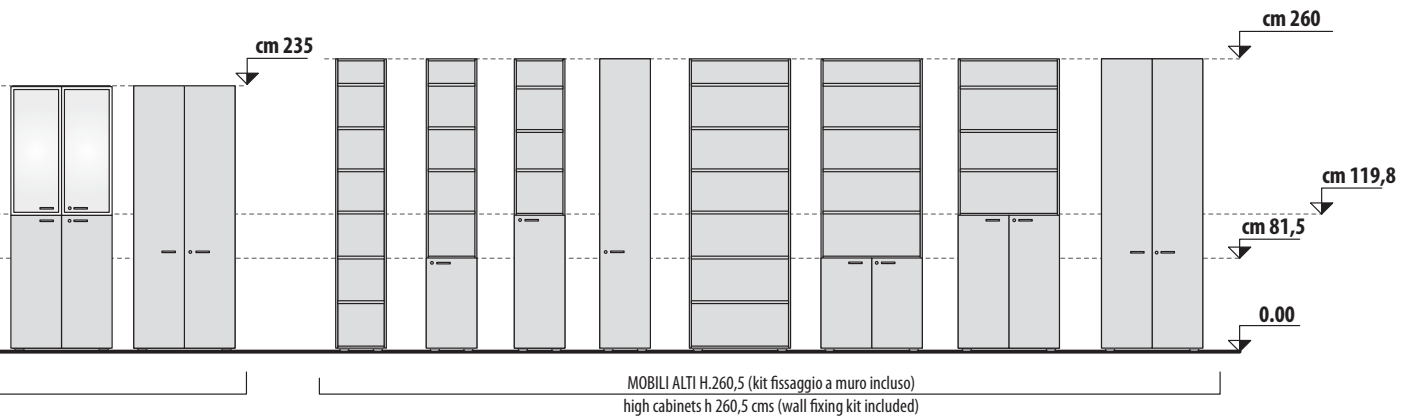
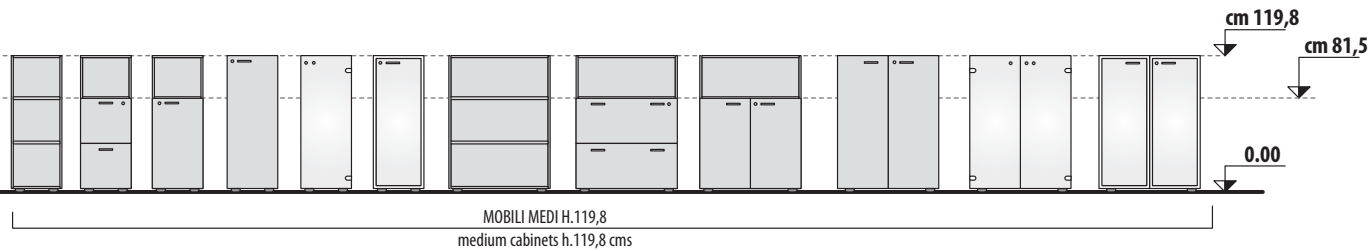

**CARTELLA COLORI**  
colours samples card

**QUESTA SERIE DI CONTENITORI UNIVERSALI EVO E' STATA CREATA PER ESSERE INTEGRATA  
CON TUTTA LA GAMMA PRODOTTI LAS MOBILI GRAZIE AI COLORI CHE PERMETTONO QUALSIASI ABBINAMENTO**  
*THIS RANGE OF UNIVERSAL CABINETS EVO HAS BEEN MADE TO BE COMBINED  
WITH ALL LAS MOBILI PRODUCT, THANKS TO THE COLOURS THAT ALLOW ANY MATCHING*



COD. 01  
ARGENTO GOLF | GOLF SILVER ○



COD. 32  
AZZURRO SKY | SKY BLUE ○



COD. 55  
ANTRACITE | ANTHRACITE ○



COD. 03  
ROVERE | OAK ○

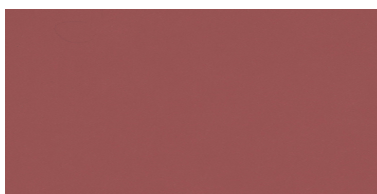

COD. 33  
AMARANTO | AMARANTH ○



COD. 58  
ACERO TAKI | TAKI MAPLE ○



COD. 04  
ROVERE GREY | GREY OAK ○

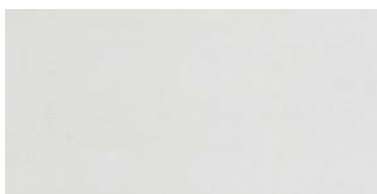

COD. 42  
GRIGIO | GREY ○

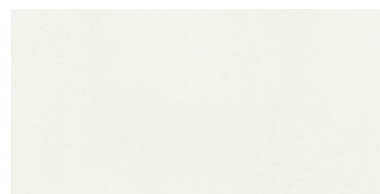

COD. 69  
BIANCO BR. | BR. WHITE ○



COD. 06  
NOCE PAVIA | PAVIA WALNUT ○



COD. 44  
STONE GREY | STONE GREY ○

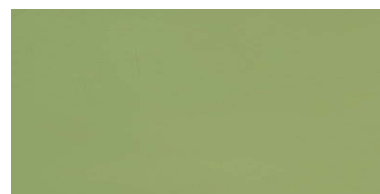

COD. 96  
VERDE BOSCO | WOOD GREEN ○



COD. 11  
GIALLO FRESIA | FREESIA YELLOW ○



COD. 45  
WENGÉ | WENGÉ ○



COD. 99  
BIANCO SATINATO | SATINED WHITE



**ABBINAMENTI COLORI**  
matching colours

**CONTENITORI UNIVERSALI EVO**  
universal cabinets

COLORI LEGNI wooden colours													
ARGENTO GOLF golf silver	NOCE PAVIA pavia walnut	STONE GREY stone grey	ANTRACITE anthracite	BIANCO BR. br. white	ROVERE oak	ROVERE GREY oak grey oak	GRIGIO grey	ACERO TAKI taki maple	WENGÈ wengè	GIALLO FRESIA freesia yellow	AZZURRO SKY sky blue	AMARANTO amaranth	VERDE BOSCO acid green

COMPONENTI components		Cod. 01	Cod. 06	Cod. 44	Cod. 55	Cod. 69	Cod. 03	Cod. 04	Cod. 42	Cod. 58	Cod. 45	Cod. 11	Cod. 32	Cod. 33	Cod. 96
CASSETTIERE pedestals	STRUTTURA structure	◇	◇	◇	◇	◇						◇	◇	◇	◇
	FRONTALI fronts	◇	◇	◇	◇	◇	◇	◇	◇	◇	◇	◇	◇	◇	◇
CONTENITORI cabinets	STRUTTURA structure	◇	◇	◇	◇	◇									
	ANTE E FRONTALI doors and fronts	◇	◇	◇	◇	◇	◇	◇	◇	◇	◇				
ANTE SEPARATE doors		◇	◇	◇	◇	◇	◇	◇	◇	◇	◇	◇	◇	◇	◇
TOPS		◇	◇	◇	◇	◇	◇	◇	◇	◇	◇				

		COLORI METALLI metal colours				ANTE VETRO glass doors	
		ARGENTO silver	BIANCO white	ANTRACITE anthracite	STONE GREY stone grey	BIANCO SATINATO satined white	ALLUMINIO aluminium
		AR 02	BI 02	AN 02	SG 01		
STRUTTURE METALLICHE PER CONTENITORI metal structure for cabinets		◇	◇	◇	◇		
ANTE VETRO glass doors	TELAIO frame						◇
	VETRO glass					◇	

CONTENITORI UNIVERSALI EVO  
universal cabinets evo

**SCHEMA DI UTILIZZO CARTELLE SU CASSETTIERA-CLASSIFICATORE**  
scheme for using folders in file-drawers

**SU CASSETTIERA CON CASSETTI LEGNO**  
pedestal with wooden drawers  
ART. 402-302-406-306

CON DOTAZIONE STANDARD ARCHIVIAZIONE EUROPEA  
European filing by standard outfit

**SU CASSETTIERA CON CASSETTI IN METALLO**  
on pedestal with metal drawers  
ART. 323-324

CON DOTAZIONE STANDARD ARCHIVIAZIONE EUROPEA  
European filing by standard outfit



**ART. 137**

POSSIBILITA' DI ARCHIVIAZIONE CON 2 ADATTATORI ART. 137  
possibility of filing by 2 fits art. 137 (see price list OYO)

**ART. 137**

POS.	TIPO DI CARTELLA type of folder	INTERASSE CENTER DISTANCE (cm)
A	GRANDE EUROPA big Europe	cm 39
B	PICCOLA EUROPA little Europe	cm 33
C	GRANDE U.S.A. big U.S.A.	cm 38,5
D	PICCOLA U.S.A. little U.S.A.	cm 31
E	GRANDE CILE big Chile	cm 37,2

= CON DOTAZIONE STANDARD ARCHIVIAZIONE EUROPEA  
= European filing by standard outfit

<b>CASSETTIERE SU RUOTE</b> <i>pedestals on wheels</i>							
DESCRIZIONE <i>description</i>	L w	CODICE <i>code</i>	KG	M <sup>3</sup>	COLLI	PREZZO <i>price</i>	(*) CODICE FINITURA <i>(*) finish code</i>
CASSETTIERE SU RUOTE 3 CASSETTI (CON SERRATURA) <i>3 drawers pedestal on wheels (with lock)</i>  		<b>CASSETTI IN LEGNO</b> <i>wooden drawers</i>					VERSIONE MONO-COLORE / <i>single-color version</i>
		114 401 (*)	24	0,152	1	€ 152,00	(*)
	CON CHIUSURA AMMORTIZZATA <i>with soft-close</i>	114 301 (*)	24	0,152	1	€ 169,00	005 ARGENTO GOLF <i>golf silver</i>
		<b>CASSETTI IN METALLO</b> <i>metal drawers</i>					166 NOCE PAVIA <i>pavia walnut</i>
	CON CHIUSURA AMMORTIZZATA <i>with soft-close</i>	114 321 (*)	26	0,152	1	€ 306,00	440 BIANCO BR. <i>br. white</i>
							551 ANTRACITE <i>anthracite</i>
							611 GIALLO FRESIA <i>freesia yellow</i>
							632 AZZURRO SKY <i>sky blue</i>
							633 AMARANTO <i>amaranth</i>
							696 VERDE BOSCO <i>wood green</i>
						844 STONE GREY <i>stone grey</i>	
L.42,1 x p.55,2 x H.57,3							VERSIONE BI-COLORE / <i>double-color version</i>
CASSETTIERA-CLASSIFICATORE SU RUOTE (CON SERRATURA) <i>file-drawer pedestal on wheels (with lock)</i>  		<b>CASSETTI IN LEGNO</b> <i>wooden drawers</i>					(*) FRONTALI STRUTTURA <i>fronts structure</i>
		114 402 (*)	23	0,152	1	€ 160,00	003 ROVERE ARGENTO GOLF <i>oak golf silver</i>
	CON CHIUSURA AMMORTIZZATA <i>with soft-close</i>	114 302 (*)	23	0,152	1	€ 171,00	004 ROVERE GREY ARGENTO GOLF <i>grey oak golf silver</i>
		<b>CASSETTI IN METALLO</b> <i>metal drawers</i>					011 GIALLO FRESIA ARGENTO GOLF <i>freesia yellow golf silver</i>
	CON CHIUSURA AMMORTIZZATA <i>with soft-close</i>	114 324 (*)	25	0,152	1	€ 289,00	015 ACERO TAKI ARGENTO GOLF <i>taki maple golf silver</i>
							025 GRIGIO ARGENTO GOLF <i>grey golf silver</i>
							030 WENGÈ ARGENTO GOLF <i>wenge golf silver</i>
							032 AZZURRO SKY ARGENTO GOLF <i>sky blue golf silver</i>
							033 AMARANTO ARGENTO GOLF <i>amaranth golf silver</i>
							040 BIANCO BR. ARGENTO GOLF <i>br. white golf silver</i>
L.42,1 x p.55,2 x H.57,3							044 STONE GREY ARGENTO GOLF <i>stone grey golf silver</i>
							051 ANTRACITE ARGENTO GOLF <i>anthracite golf silver</i>
							066 NOCE PAVIA ARGENTO GOLF <i>pavia walnut golf silver</i>
							096 VERDE BOSCO ARGENTO GOLF <i>wood green golf silver</i>
							403 ROVERE BIANCO BR. <i>oak br. white</i>
							404 ROVERE GREY BIANCO BR. <i>grey oak br. white</i>
							405 ARGENTO GOLF BIANCO BR. <i>golf silver br. white</i>
							411 GIALLO FRESIA BIANCO BR. <i>freesia yellow br. white</i>
							415 ACERO TAKI BIANCO BR. <i>taki maple br. white</i>
							430 WENGÈ BIANCO BR. <i>wenge br. white</i>
							432 AZZURRO SKY BIANCO BR. <i>sky blue br. white</i>
							433 AMARANTO BIANCO BR. <i>amaranth br. white</i>
							444 STONE GREY BIANCO BR. <i>stone grey br. white</i>
							451 ANTRACITE BIANCO BR. <i>anthracite br. white</i>
							466 NOCE PAVIA BIANCO BR. <i>pavia walnut br. white</i>
							496 VERDE BOSCO BIANCO BR. <i>wood green br. white</i>
							503 ROVERE ANTRACITE <i>oak anthracite</i>
							504 ROVERE GREY ANTRACITE <i>grey oak anthracite</i>
							506 ARGENTO GOLF ANTRACITE <i>golf silver anthracite</i>
							511 GIALLO FRESIA ANTRACITE <i>freesia yellow anthracite</i>
							516 ACERO TAKI ANTRACITE <i>taki maple anthracite</i>
							531 WENGÈ ANTRACITE <i>wenge anthracite</i>
							532 AZZURRO SKY ANTRACITE <i>sky blue anthracite</i>
							533 AMARANTO ANTRACITE <i>amaranth anthracite</i>
							541 BIANCO BR. ANTRACITE <i>br. white anthracite</i>
							544 STONE GREY ANTRACITE <i>stone grey anthracite</i>
							566 NOCE PAVIA ANTRACITE <i>pavia walnut anthracite</i>
							596 VERDE BOSCO ANTRACITE <i>wood green anthracite</i>
							803 ROVERE STONE GREY <i>oak stone grey</i>
							804 ROVERE GREY STONE GREY <i>grey oak stone grey</i>
							805 ARGENTO GOLF STONE GREY <i>golf silver stone grey</i>
							811 GIALLO FRESIA STONE GREY <i>freesia yellow stone grey</i>
							815 ACERO TAKI STONE GREY <i>taki maple stone grey</i>
							830 WENGÈ STONE GREY <i>wenge stone grey</i>
							832 AZZURRO SKY STONE GREY <i>sky blue stone grey</i>
							833 AMARANTO STONE GREY <i>amaranth stone grey</i>
							840 BIANCO BR. STONE GREY <i>br. white stone grey</i>
							851 ANTRACITE STONE GREY <i>anthracite stone grey</i>
							866 NOCE PAVIA STONE GREY <i>pavia walnut stone grey</i>
							896 VERDE BOSCO STONE GREY <i>wood green stone grey</i>
							PER SCHEMA DI UTILIZZO CARTELLE SU CASSETTO CLASSIFICATORE VEDI PAG. 7 <i>for scheme for using folders in file-drawer, please see page 7</i>

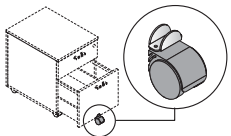
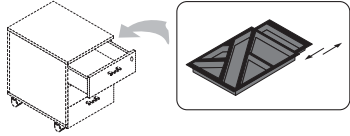

ACCESSORI PER CASSETTIERE accessories for pedestals																
DESCRIZIONE description	L w	CODICE code	KG	M <sup>3</sup>	COLLI	PREZZO price	(*) CODICE FINITURA (*) finish code									
5a RUOTA OPZIONALE PER CASSETTIERA-CLASSIFICATORE fifth optional wheels for file-pedestal ART.402-302-424-324-406-306-423-323 		175 105 (*)	1	0,001	1	€ 13,00	<table border="1"> <thead> <tr> <th>(*)</th> <th>PIASTRINO plate</th> <th>RUOTA wheels</th> </tr> </thead> <tbody> <tr> <td>000</td> <td>ARGENTO silver</td> <td><b>NERA</b> black</td> </tr> <tr> <td>300</td> <td>ARGENTO silver</td> <td><b>GRIGIA</b> grey</td> </tr> </tbody> </table>	(*)	PIASTRINO plate	RUOTA wheels	000	ARGENTO silver	<b>NERA</b> black	300	ARGENTO silver	<b>GRIGIA</b> grey
	(*)	PIASTRINO plate	RUOTA wheels													
	000	ARGENTO silver	<b>NERA</b> black													
300	ARGENTO silver	<b>GRIGIA</b> grey														
PORTA CANCELLERIA INTERNO PER CASSETTIERA internal stationery holder for drawers   L.32,5-45 x p.22 x H.2,5		175 186 (*)	1	0,004	1	€ 18,00	<table border="1"> <thead> <tr> <th>(*)</th> <th colspan="2"></th> </tr> </thead> <tbody> <tr> <td>500</td> <td>NERO</td> <td>black</td> </tr> </tbody> </table>	(*)			500	NERO	black			
	(*)															
500	NERO	black														

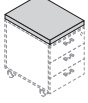
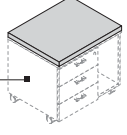
CUSCINI PER CASSETTIERE E MOBILI DI SERVIZIO									
cushions for pedestals or service units									
DESCRIZIONE description	CODICE code	KG	M <sup>3</sup>	COLLI	PREZZO price	PREZZO price	(*) CODICE FINITURA (*) finish code		
<p>CUSCINO PER CASSETTIERE SU RUOTE cushion for pedestals on wheels</p>  <p>L.42,1 x p.55,2 x H.3 w 16½" x d 21¾" x h 1¼"</p>	114 956 (*)	2	0,020	1	€ 44,00	€ 51,00	<b>CAT. A</b>		
							(*)	TESSUTO POLIPROPILENE IGNIFUGO	fire-retardant polypropylene fabric
							101	BLU	blue
							102	ROSSO	red
							104	AZZURRO	azure
							105	VERDE	green
							106	ARANCIO	orange
							107	NERO	black
							108	GRIGIO	grey
							109	GIALLO	yellow
							112	VERDE CHIARO	light green
							113	BORDEAUX	bordeaux
							114	GRIGIO MELANGE	melange grey
							<p>CUSCINO PER MOBILI DI SERVIZIO ART.188-189 cushions for service unit art. 188-189</p>  <p>ART.188-189</p> <p>L.67,7 x p.55,2 x H.3</p>	114 957 (*)	3
(*)	TESSUTO POLIESTERE STRETCH IGNIFUGO	fire-retardant stretch polyester fabric							
320	AZZURRO SKY	sky blue							
321	GIALLO FRESIA	freesia yellow							
322	AMARANTO	amaranth							
323	VERDE BOSCO	wood green							
325	ANTRACITE	anthracite							
326	NERO	black							
327	GRIGIO	grey							
328	TORTORA	grey beige							
330	MATONE	brick red							
331	ARANCIO	orange							
332	ROSSO	red							
333	VERDE ACIDO	acid green							
334	BLU	blue							

**Cat. A**

 **TESSUTO POLIPROPILENE IGNIFUGO** 100% polipropilene FR Martindale 45.000

**FIRE-RETARDANT POLYPROPYLENE FABRIC** 100% polypropylene FR Martindale 45.000



101 BLU | BLUE

102 ROSSO | RED

104 AZZURRO | AZURE

105 VERDE | GREEN

106 ARANCIO | ORANGE

107 NERO | BLACK

108 GRIGIO | GREY

109 GIALLO | YELLOW

112 VERDE CHIARO | LIGHT GREEN

113 BORDEAUX | BORDEAUX

114 GRIGIO MELANGE | MEL. GREY

**Cat. F**

 **POLIESTERE STRETCH IGNIFUGO** 100% poliestere FR riciclato Martindale 50.000

**FIRE-RETARDANT STRETCH POLYESTER** 100% polyester FR recycled Martindale 50.000



320 AZZURRO SKY | SKY BLUE

321 GIALLO FRESIA | FREESIA YELLOW

322 AMARANTO | AMARANTH

323 VERDE BOSCO | WOOD GREEN

325 ANTRACITE | ANTHRACITE

326 NERO | BLACK

327 GRIGIO | GREY

328 TORTORA | GREY BEIGE

330 MATONE | BRICK RED



331 ARANCIO | ORANGE

332 ROSSO | RED

333 VERDE ACIDO | ACID GREEN

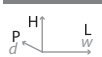

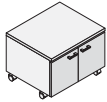
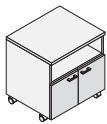
334 BLU | BLUE



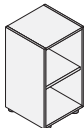

MOBILI SU RUOTE cabinets on wheels							
DESCRIZIONE description	L w	CODICE code	KG	M <sup>3</sup>	COLLI	PREZZO price	(*) CODICE FINITURA (* finish code)
MOBILE PORTA-FOTOCOPIATRICE SU RUOTE photocopier stand on wheels    L.65 x p.55 x H.47	L.65	114 410 (*)	28	0,197	1	€ 141,00	
	VERSIONE MONO-COLORE / single-color version						
MOBILE PORTA-FOTOCOPIATRICE SU RUOTE photocopier stand on wheels    L.65 x p.55 x H.62	L.65	114 409 (*)	34	0,266	1	€ 148,00	
	VERSIONE BI-COLORE / double-color version						
MOBILE DI SERVIZIO SU RUOTE CON SERRATURA service unit on wheels with lock    L.67,7 x p.55,1 x H.56,8	CASSETTI IN LEGNO wooden drawers						
	L.67,7	114 188 (*)	26	0,255	1	€ 215,00	
CASSETTI IN LEGNO wooden drawers		CON CHIUSURA AMMORTIZZATA with soft-close					
L.67,7	114 189 (*)	26	0,255	1	€ 232,00		
<b>CONTENITORE BASSO H.81,5</b> low cabinet h 81,5 cms							
MOBILE BASSO L.45 CON 4 CASSETTI SENZA SERRATURA low cabinet w 45 cms with 4 drawers without lock    L.45 x p.46,3 x H.81,5	CASSETTI IN LEGNO wooden drawers						
	L.45	114 597 (*)	33	0,230	1	€ 188,00	
CASSETTI IN LEGNO wooden drawers		CON CHIUSURA AMMORTIZZATA with soft-close					
L.45	114 597 (*)	33	0,230	1	€ 188,00		
							(*) ARGENTO GOLF      golf silver (*) NOCE PAVIA      pavia walnut (*) BIANCO BR.      br. white (*) ANTRACITE      anthracite (*) STONE GREY      stone grey  (*) ROVERE ARGENTO GOLF      oak      golf silver (*) ROVERE GREY ARGENTO GOLF      grey oak      golf silver (*) GIALLO FRESIA ARGENTO GOLF      freesia yellow      golf silver (*) ACERO TAKI ARGENTO GOLF      taki maple      golf silver (*) GRIGIO ARGENTO GOLF      grey      golf silver (*) WENGE' ARGENTO GOLF      wenge      golf silver (*) AZZURRO SKY ARGENTO GOLF      sky blue      golf silver (*) AMARANTO ARGENTO GOLF      amaranth      golf silver (*) BIANCO BR. ARGENTO GOLF      br. white      golf silver (*) STONE GREY ARGENTO GOLF      stone grey      golf silver (*) ANTRACITE ARGENTO GOLF      anthracite      golf silver (*) NOCE PAVIA ARGENTO GOLF      pavia walnut      golf silver (*) VERDE BOSCO ARGENTO GOLF      wood green      golf silver (*) ROVERE BIANCO BR.      oak      br. white (*) ROVERE GREY BIANCO BR.      grey oak      br. white (*) ARGENTO GOLF BIANCO BR.      golf silver      br. white (*) GIALLO FRESIA BIANCO BR.      freesia yellow      br. white (*) ACERO TAKI BIANCO BR.      taki maple      br. white (*) WENGE' BIANCO BR.      wenge      br. white (*) AZZURRO SKY BIANCO BR.      sky blue      br. white (*) AMARANTO BIANCO BR.      amaranth      br. white (*) STONE GREY BIANCO BR.      stone grey      br. white (*) ANTRACITE BIANCO BR.      anthracite      br. white (*) NOCE PAVIA BIANCO BR.      pavia walnut      br. white (*) VERDE BOSCO BIANCO BR.      wood green      br. white (*) ROVERE ANTRACITE      oak      anthracite (*) ROVERE GREY ANTRACITE      grey oak      anthracite (*) ARGENTO GOLF ANTRACITE      golf silver      anthracite (*) GIALLO FRESIA ANTRACITE      freesia yellow      anthracite (*) ACERO TAKI ANTRACITE      taki maple      anthracite (*) WENGE' ANTRACITE      wenge      anthracite (*) AZZURRO SKY ANTRACITE      sky blue      anthracite (*) AMARANTO ANTRACITE      amaranth      anthracite (*) BIANCO BR. ANTRACITE      br. white      anthracite (*) STONE GREY ANTRACITE      stone grey      anthracite (*) NOCE PAVIA ANTRACITE      pavia walnut      anthracite (*) VERDE BOSCO ANTRACITE      wood green      anthracite (*) ROVERE STONE GREY      oak      stone grey (*) ROVERE GREY STONE GREY      grey oak      stone grey (*) ARGENTO GOLF STONE GREY      golf silver      stone grey (*) GIALLO FRESIA STONE GREY      freesia yellow      stone grey (*) ACERO TAKI STONE GREY      taki maple      stone grey (*) WENGE' STONE GREY      wenge      stone grey (*) AZZURRO SKY STONE GREY      sky blue      stone grey (*) AMARANTO STONE GREY      amaranth      stone grey (*) BIANCO BR. STONE GREY      br. white      stone grey (*) ANTRACITE STONE GREY      anthracite      stone grey (*) NOCE PAVIA STONE GREY      pavia walnut      stone grey (*) VERDE BOSCO STONE GREY      wood green      stone grey

CONTENITORI UNIVERSALI EVO  
universal cabinets EVO

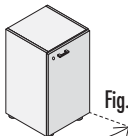
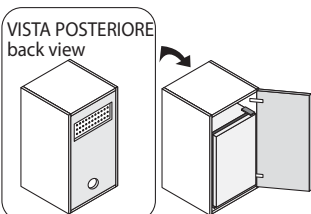

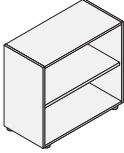

CONTENITORI BASSI H.81,5 low cabinets h 81,5 cms							COMPLETARE CON TOP DI FINITURA (VEDI PAG. 30) complete with finishing top (please see page 30)			
DESCRIZIONE description	L w	CODICE code	KG	M <sup>3</sup>	COLLI	PREZZO price	(*) CODICE FINITURA (*) finish code			
MOBILE BASSO A GIORNO L.45 open low cabinet w 45 cms  	L.45	114 800 (*)	20	0,047	2	€ 77,00	(*)			
	PROF. CM 35 depth 35 cms		● = COLORI DISPONIBILI available colours				(*)			
	L.45	114 801 (*)	18	0,044	2	€ 69,00	(*)			
								(*) STRUTTURA / structure ● 005 ARGENTO GOLF / golf silver 166 NOCE PAVIA / pavia walnut ● 440 BIANCO BR. / br. white 551 ANTRACITE / anthracite 844 STONE GREY / stone grey		
L.45 x p.44,5 x H.81,5										
MOBILE BASSO L.45 CON 2 CASSETTI CLASSIFICATORI CON SERRATURA low cabinet 17 3/4" with 2 file drawers with lock  	L.45	114 802 (*)	36	0,214	3	€ 249,00	VERSIONE MONO-COLORE / single-color version			
	PER SCHEMA DI UTILIZZO CARTELLE SU CASSETTO CLASSIFICATORE VEDI PAG.31 for scheme for using folders in file-drawer, please see page 31							(*)		
								(*) FRONTALI / fronts 005 ARGENTO GOLF / golf silver 166 NOCE PAVIA / pavia walnut 440 BIANCO BR. / br. white 551 ANTRACITE / anthracite 844 STONE GREY / stone grey		
								VERSIONE BI-COLORE / double-color version (*) FRONTALI / fronts    STRUTTURA / structure    fronts    structure 003 ROVERE ARGENTO GOLF / oak / golf silver 004 ROVERE GREY ARGENTO GOLF / grey oak / golf silver 015 ACERO TAKI ARGENTO GOLF / taki maple / golf silver 025 GRIGIO ARGENTO GOLF / grey / golf silver 030 WENGÉ ARGENTO GOLF / wenge / golf silver 040 BIANCO BR. ARGENTO GOLF / br. white / golf silver 044 STONE GREY ARGENTO GOLF / stone grey / golf silver 051 ANTRACITE ARGENTO GOLF / anthracite / golf silver 066 NOCE PAVIA ARGENTO GOLF / pavia walnut / golf silver 403 ROVERE BIANCO BR. / oak / br. white 404 ROVERE GREY BIANCO BR. / grey oak / br. white 405 ARGENTO GOLF BIANCO BR. / golf silver / br. white 415 ACERO TAKI BIANCO BR. / taki maple / br. white 430 WENGÉ BIANCO BR. / wenge / br. white 444 STONE GREY BIANCO BR. / stone grey / br. white 451 ANTRACITE BIANCO BR. / anthracite / br. white 466 NOCE PAVIA BIANCO BR. / pavia walnut / br. white 503 ROVERE ANTRACITE / oak / anthracite 504 ROVERE GREY ANTRACITE / grey oak / anthracite 506 ARGENTO GOLF ANTRACITE / golf silver / anthracite 516 ACERO TAKI ANTRACITE / taki maple / anthracite 531 WENGÉ ANTRACITE / wenge / anthracite 541 BIANCO BR. ANTRACITE / br. white / anthracite 544 STONE GREY ANTRACITE / stone grey / anthracite 566 NOCE PAVIA ANTRACITE / pavia walnut / anthracite 803 ROVERE STONE GREY / oak / stone grey 804 ROVERE GREY STONE GREY / grey oak / stone grey 805 ARGENTO GOLF STONE GREY / golf silver / stone grey 815 ACERO TAKI STONE GREY / taki maple / stone grey 830 WENGÉ STONE GREY / wenge / stone grey 840 BIANCO BR. STONE GREY / br. white / stone grey 851 ANTRACITE STONE GREY / anthracite / stone grey 866 NOCE PAVIA STONE GREY / pavia walnut / stone grey		
L.45 x p.46,3 x H.81,5										
MOBILE BASSO L.45 CON 1 ANTA LEGNO COMPLETA DI SERRATURA low cabinet w 45 cms with 1 wooden door with lock   Fig.DX/right	DX right	L.45	114 803 (*)	25	0,069	3	€ 108,00			
	SX left	L.45	114 804 (*)							
								(*)		
								(*)		
L.45 x p.46,3 x H.81,5										
MOBILE BASSO L.45 CON 1 ANTA LEGNO DX CON SERRATURA, COMPLETO DI FRIGORIFERO DA LT. 38+ GRIGLIA DI AERAZIONE low cabinet w 45 cms with right wooden door with lock, and refrigerator 38 liters+airing grid  VISTA POSTERIORE back view 	DX right	L.45	114 809 (*)	44	0,183	4	€ 920,00			
	DIMENSIONI FRIGORIFERO: L.39 x p.40 x H.54,2 dimensions of refrigerator: w 39 x d 40 x h 54,2									
								(*)		
								(*)		
L.45 x p.46,3 x H.81,5										

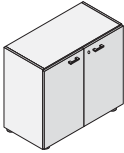

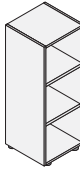

CONTENITORI BASSI H.81,5 low cabinets h 81,5 cms							COMPLETARE CON TOP DI FINITURA (VEDI PAG. 30) complete with finishing top (please see page 30)		
DESCRIZIONE description	L w	CODICE code	KG	M <sup>3</sup>	COLLI	PREZZO price	(*) CODICE FINITURA (*) finish code		
MOBILE BASSO A GIORNO L.90 open low cabinet w 90 cms  	L.90	114 810 (*)	31	0,072	2	€ 113,00	(*)		
	PROF. CM 35 depth 35 cms		● = COLORI DISPONIBILI available colours					(*)	
	L.90	114 811 (*)	28	0,065	2	€ 100,00	(*)		
								(*)	
MOBILE BASSO L.90 CON 2 CASSETTI CLASSIFICATORI CON SERRATURA low cabinet w 90 cms with 2 file drawers with lock  	L.90	114 806 (*)	53	0,400	3	€ 329,00	VERSIONE MONO-COLORE / single-color version		
			PER SCHEMA DI UTILIZZO CARTELLE SU CASSETTO CLASSIFICATORE VEDI PAG.31 for scheme for using folders in file-drawer, please see page 31					(*)	
								VERSIONE BI-COLORE / double-color version	
								(*)	
MOBILE BASSO L.90 CON 2 ANTE LEGNO CON SERRATURA low cabinet w 90 cms with 2 wooden doors with lock  	L.90	114 807 (*)	41	0,105	3	€ 165,00	(*)		
								(*)	
								(*)	
								(*)	

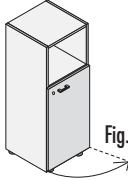
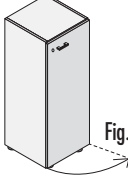
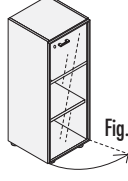
CONTENITORI UNIVERSALI EVO  
universal cabinets EVO

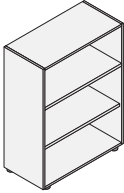

CONTENITORI MEDI H.119,8 medium cabinets h. 119,8 cms							COMPLETARE CON TOP DI FINITURA (VEDI PAG. 30) complete with finishing top (please see page 30)					
DESCRIZIONE description	L w	CODICE code	KG	M <sup>3</sup>	COLLI	PREZZO price	(*) CODICE FINITURA (*) finish code					
MOBILE MEDIO A GIORNO L.45 open medium cabinet w 45 cms  L.45 x p.44,5 x H.119,8	L.45	114 813 (*)	35	0,072	3	€ 110,00	(*)	STRUTTURA	structure			
							005	ARGENTO GOLF	golf silver			
							166	NOCE PAVIA	pavia walnut			
							440	BIANCO BR.	br. white			
							551	ANTRACITE	anthracite			
							844	STONE GREY	stone grey			
PROF. CM 35 depth 35 cms							● = COLORI DISPONIBILI available colours					
L.45	114 814 (*)	29	0,069	3	€ 99,00							
MOBILE MEDIO L.45 CON 2 CASSETTI CLASSIFICATORI CON SERRATURA medium cabinet w 45 cms with 2 file-drawers door with lock  L.45 x p.46,3 x H.119,8 w 45 cms x d 18¼" x h 47¼"	L.45	114 830 (*)	48	0,230	3	€ 268,00	VERSIONE MONO-COLORE / single-color version					
							(*)					
							005	ARGENTO GOLF	golf silver			
							166	NOCE PAVIA	pavia walnut			
							440	BIANCO BR.	br. white			
							551	ANTRACITE	anthracite			
							844	STONE GREY	stone grey			
PER SCHEMA DI UTILIZZO CARTELLE SU CASSETTO CLASSIFICATORE VEDI PAG.31 for scheme for using folders in file-drawer , please see page 31							VERSIONE BI-COLORE / double-color version					
							(*)	FRONTALI	STRUTTURA	fronts	structure	
							003	ROVERE	ARGENTO GOLF	oak	golf silver	
							004	ROVERE GREY	ARGENTO GOLF	grey oak	golf silver	
							015	ACERO TAKI	ARGENTO GOLF	taki maple	golf silver	
							025	GRIGIO	ARGENTO GOLF	grey	golf silver	
							030	WENGÉ	ARGENTO GOLF	wenge	golf silver	
							040	BIANCO BR.	ARGENTO GOLF	br. white	golf silver	
							044	STONE GREY	ARGENTO GOLF	stone grey	golf silver	
							051	ANTRACITE	ARGENTO GOLF	anthracite	golf silver	
							066	NOCE PAVIA	ARGENTO GOLF	pavia walnut	golf silver	
							403	ROVERE	BIANCO BR.	oak	br. white	
							404	ROVERE GREY	BIANCO BR.	grey oak	br. white	
							405	ARGENTO GOLF	BIANCO BR.	golf silver	br. white	
							415	ACERO TAKI	BIANCO BR.	taki maple	br. white	
							430	WENGÉ	BIANCO BR.	wenge	br. white	
							444	STONE GREY	BIANCO BR.	stone grey	br. white	
							451	ANTRACITE	BIANCO BR.	anthracite	br. white	
							466	NOCE PAVIA	BIANCO BR.	pavia walnut	br. white	
							503	ROVERE	ANTRACITE	oak	anthracite	
							504	ROVERE GREY	ANTRACITE	grey oak	anthracite	
							506	ARGENTO GOLF	ANTRACITE	golf silver	anthracite	
							516	ACERO TAKI	ANTRACITE	taki maple	anthracite	
							531	WENGÉ	ANTRACITE	wenge	anthracite	
							541	BIANCO BR.	ANTRACITE	br. white	anthracite	
							544	STONE GREY	ANTRACITE	stone grey	anthracite	
							566	NOCE PAVIA	ANTRACITE	pavia walnut	anthracite	
							803	ROVERE	STONE GREY	oak	stone grey	
							804	ROVERE GREY	STONE GREY	grey oak	stone grey	
							805	ARGENTO GOLF	STONE GREY	golf silver	stone grey	
							815	ACERO TAKI	STONE GREY	taki maple	stone grey	
							830	WENGÉ	STONE GREY	wenge	stone grey	
							840	BIANCO BR.	STONE GREY	br. white	stone grey	
							851	ANTRACITE	STONE GREY	anthracite	stone grey	
							866	NOCE PAVIA	STONE GREY	pavia walnut	stone grey	
							(*)	STRUTTURA	structure			
							005	ARGENTO GOLF		golf silver		
							166	NOCE PAVIA		pavia walnut		
							440	BIANCO BR.		br. white		
							551	ANTRACITE		anthracite		
							844	STONE GREY		stone grey		
MOBILE MEDIO L.45 CON 1 ANTA LEGNO CON SERRATURA medium cabinet w 45 cms with 1 low wooden door with lock  L.45 x p.46,3 x H.119,8 Fig.DX/right	DX right	L.45	114 831 (*)	40	0,095	4	€ 141,00					
	SX left	L.45	114 832 (*)									
	MOBILE MEDIO L.45 CON 1 ANTA LEGNO CON SERRATURA medium cabinet w 45 cms with 1 wooden door with lock  L.45 x p.46,3 x H.119,8 Fig.DX/right	DX right	L.45	114 833 (*)	42	0,103	4	€ 148,00				
		SX left	L.45	114 834 (*)								
MOBILE MEDIO L.45 CON 1 ANTA VETRO CON SERRATURA medium cabinet w 45 cms with 1 glass door with lock  L.45 x p.46,3 x H.119,8 Fig.DX/right		DX right	L.45	114 842 (*)	44	0,106	5	€ 217,00	(*)	STRUTTURA	structure	
		SX left	L.45	114 843 (*)								
									166	NOCE PAVIA	pavia walnut	
									440	BIANCO BR.	br. white	
MOBILI FORNITI CON ANTA: TELAIO ALLUMINIO E VETRO TEMPERATO SATINATO supplied cabinets with door: aluminium frame and tempered satined glass												
								551	ANTRACITE	anthracite		
								844	STONE GREY	stone grey		

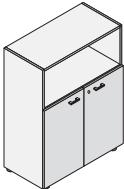
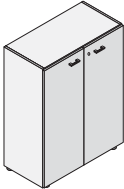
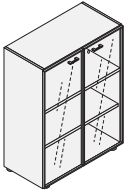





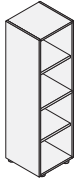

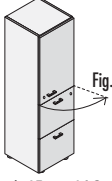
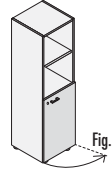
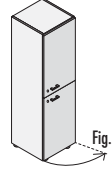
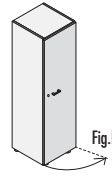
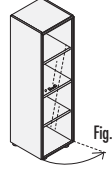
CONTENITORI MEDI H.119,8 medium cabinets h. 119,8 cms							COMPLETARE CON TOP DI FINITURA (VEDI PAG. 30) complete with finishing top (please see page 30)				
DESCRIZIONE description	L w	CODICE code	KG	M <sup>3</sup>	COLLI	PREZZO price	(*) CODICE FINITURA (*) finish code				
MOBILE MEDIO A GIORNO L.90 open medium cabinet w 90 cms  L.90 x p.44,5 x H.119,8	L.90	114 818 (*)	49	0,100	2	€ 159,00	(*)	STRUTTURA	structure		
	PROF. CM 35 depth 35 cms		●= COLORI DISPONIBILI available colours				● 005	ARGENTO GOLF	golf silver		
	L.90	114 819 (*)	43	0,101	3	€ 144,00	● 166	NOCE PAVIA	pavia walnut		
MOBILE MEDIO L.90 CON 2 CASSETTI CLASSIFICATORI CON SERRATURA medium cabinet w 90 cms with 2 file-drawers door with lock  L.90 x p.46,3 x H.119,8	L.90	114 844 (*)	66	0,418	3	€ 354,00	VERSIONE MONO-COLORE / single-color version				
	PER SCHEMA DI UTILIZZO CARTELLE SU CASSETTO CLASSIFICATORE VEDI PAG.31 for scheme for using folders in file-drawer , please see page 31						● 440	BIANCO BR.	br. white		
							● 551	ANTRACITE	anthracite		
MOBILE MEDIO L.90 CON 2 ANTE BASSE LEGNO CON SERRATURA medium cabinet w 90 cms with 2 low wooden doors with lock  L.90 x p.46,3 x H.119,8	L.90	114 846 (*)	59	0,133	3	€ 211,00	VERSIONE BI-COLORE / double-color version				
							(*)	FRONTALI	STRUTTURA	fronts	structure
							003	ROVERE	ARGENTO GOLF	oak	golf silver
MOBILE MEDIO L.90 CON 2 ANTE LEGNO CON SERRATURA medium cabinet w 90 cms with 2 wooden doors with lock  L.90 x p.46,3 x H.119,8	L.90	114 847 (*)	63	0,149	3	€ 225,00					
							004	ROVERE GREY	ARGENTO GOLF	grey oak	golf silver
							005	ARGENTO GOLF	BIANCO BR.	golf silver	br. white
MOBILE MEDIO L.90 CON 2 ANTE VETRO CON SERRATURA medium cabinet w 90 cms with 2 glass doors with lock  L.90 x p.46,3 x H.119,8	L.90	114 848 (*)	66	0,165	5	€ 369,00					
	MOBILI FORNITI CON ANTE: TELAIO ALLUMINIO E VETRO TEMPERATO SATINATO supplied cabinets with doors: aluminium frame and tempered satined glass						440	BIANCO BR.	br. white		
							551	ANTRACITE	anthracite		

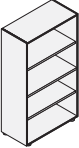
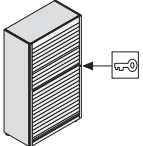
CONTENITORI UNIVERSALI EVO  
universal cabinets EVO



CONTENITORI MEDI H.158,3 medium cabinets h. 158,3 cms							COMPLETARE CON TOP DI FINITURA (VEDI PAG. 30) complete with finishing top (please see page 30)						
DESCRIZIONE description	L w	CODICE code	KG	M <sup>3</sup>	COLLI	PREZZO price	(*) CODICE FINITURA (*) finish code						
MOBILE MEDIO A GIORNO L.45 open medium cabinet w 45 cms  L.45 x p.44,5 x H.158,3	L.45	114 815 (*)	36	0,088	3	€ 138,00	(*)	STRUTTURA	structure				
	PROF. CM 35 depth 35 cms		● = COLORI DISPONIBILI available colours				(*)	005	ARGENTO GOLF	golf silver			
	L.45	114 816 (*)	37	0,082	3	€ 121,00	(*)	166	NOCE PAVIA	pavia walnut			
							(*)	440	BIANCO BR.	br. white			
MOBILE MEDIO L.45 CON 2 CASSETTI CLASSIFICATORI CON SERR. medium cabinet w 45 cms with 2 file-drawers with lock  L.45 x p.46,3 x H.158,3	L.45	114 851 (*)	48	0,251	4	€ 304,00	VERSIONE MONO-COLORE / single-color version						
	PER SCHEMA DI UTILIZZO CARTELLE SU CASSETTO CLASSIFICATORE VEDI PAG.31 for scheme for using folders in file-drawer , please see page 31						(*)	005	ARGENTO GOLF	golf silver			
							(*)	166	NOCE PAVIA	pavia walnut			
							(*)	440	BIANCO BR.	br. white			
MOBILE MEDIO L.45 CON 2 CASSETTI CLASSIFICATORI+ 1 ANTA LEGNO CON SERRATURE medium cabinet w 45 cms with 2 file-drawers+1 wooden door with locks  L.45 x p.46,3 x H.158,3	DX right	L.45	114 852 (*)	53	0,273	5	€ 335,00	VERSIONE BI-COLORE / double-color version					
	SX left	L.45	114 853 (*)					(*)	FRONTALI	STRUTTURA	fronts	structure	
	PER SCHEMA DI UTILIZZO CARTELLE SU CASSETTO CLASSIFICATORE VEDI PAG.31 for scheme for using folders in file-drawer , please see page 31						(*)	003	ROVERE	ARGENTO GOLF	oak	golf silver	
							(*)	004	ROVERE GREY	ARGENTO GOLF	grey oak	golf silver	
MOBILE MEDIO L.45 CON 1 ANTA BASSA LEGNO CON SERRATURA medium cabinet w 45 cms with 1 low wooden door with lock  L.45 x p.46,3 x H.158,3	DX right	L.45	114 856 (*)	41	0,111	4	€ 169,00	(*)	015	ACERO TAKI	ARGENTO GOLF	taki maple	golf silver
	SX left	L.45	114 857 (*)					(*)	030	WENGÉ'	ARGENTO GOLF	wenge	golf silver
							(*)	040	BIANCO BR.	ARGENTO GOLF	br. white	golf silver	
							(*)	044	STONE GREY	ARGENTO GOLF	stone grey	golf silver	
MOBILE MEDIO L.45 CON 2 ANTE LEGNO CON SERRATURE medium cabinet w 45 cms with 2 wooden doors with locks  L.45 x p.46,3 x H.158,3	DX right	L.45	114 858 (*)	46	0,133	5	€ 200,00	(*)	051	ANTRACITE	ARGENTO GOLF	anthracite	golf silver
	SX left	L.45	114 859 (*)					(*)	066	NOCE PAVIA	ARGENTO GOLF	pavia walnut	golf silver
							(*)	403	ROVERE	BIANCO BR.	oak	br. white	
							(*)	404	ROVERE GREY	BIANCO BR.	grey oak	br. white	
MOBILE MEDIO L.45 CON 1 ANTA LEGNO CON SERRATURA medium cabinet w 45 cms with 1 wooden door with lock  L.45 x p.46,3 x H.158,3	DX right	L.45	114 860 (*)	46	0,131	4	€ 191,00	(*)	405	ARGENTO GOLF	BIANCO BR.	golf silver	br. white
	SX left	L.45	114 861 (*)					(*)	415	ACERO TAKI	BIANCO BR.	taki maple	br. white
							(*)	430	WENGÉ'	BIANCO BR.	wenge	br. white	
							(*)	444	STONE GREY	BIANCO BR.	stone grey	br. white	
MOBILE MEDIO L.45 CON 1 ANTA VETRO CON SERRATURA medium cabinet w 45 cms with 1 glass door with lock  L.45 x p.46,3 x H.158,3	DX right	L.45	114 862 (*)	48	0,130	5	€ 272,00	(*)	005	ARGENTO GOLF	golf silver		
	SX left	L.45	114 863 (*)					(*)	166	NOCE PAVIA	pavia walnut		
	MOBILI FORNITI CON ANTA: TELAIO ALLUMINIO E VETRO TEMPERATO SATINATO supplied cabinets with door: aluminium frame and tempered satined glass						(*)	440	BIANCO BR.	br. white			
							(*)	551	ANTRACITE	anthracite			

CONTENITORI MEDI H.158,3 medium cabinets h. 158,3 cms							COMPLETARE CON TOP DI FINITURA (VEDI PAG. 30) complete with finishing top (please see page 30)				
DESCRIZIONE description	L w	CODICE code	KG	M <sup>3</sup>	COLLI	PREZZO price	(*) CODICE FINITURA (*) finish code				
MOBILE MEDIO A GIORNO L.90 open medium cabinet w 90 cms  L.90 x p.44,5 x H.158,3	L.90	114 820 (*)	57	0,135	3	€ 203,00	(*)	STRUTTURA	structure		
							005	ARGENTO GOLF	golf silver		
							166	NOCE PAVIA	pavia walnut		
		PROF. CM 35 depth 35 cms					● = COLORI DISPONIBILI available colours				
	L.90	114 821 (*)	54	0,126	3	€ 182,00	440	BIANCO BR.	br. white		
							551	ANTRACITE	anthracite		
							844	STONE GREY	stone grey		
MOBILE MEDIO L.90 CON SERRANDINA CON SERRATURA medium cabinet w 90 cms with rolling shutter with lock  L.90 x p.46,3 x H.158,3	L.90	114 822 (*)	67	0,526	5	€ 521,00	(*)	STRUTTURA	structure		
							005	ARGENTO GOLF	golf silver		
							166	NOCE PAVIA	pavia walnut		
							440	BIANCO BR.	br. white		
							551	ANTRACITE	anthracite		
							844	STONE GREY	stone grey		
							SERRANDINA ARGENTO METALLIZZATO metallic silver rolling shutter				
MOBILE MEDIO L.90 CON 2 CASSETTI CLASSIFICATORI CON SERR. medium cabinet w 90 cms with 2 file-drawers with lock  L.90 x p.46,3 x H.158,3	L.90	114 864 (*)	73	0,446	3	€ 403,00	VERSIONE MONO-COLORE / single-color version				
							(*)				
								005	ARGENTO GOLF	golf silver	
							166	NOCE PAVIA	pavia walnut		
							440	BIANCO BR.	br. white		
							551	ANTRACITE	anthracite		
							844	STONE GREY	stone grey		
							PER SCHEMA DI UTILIZZO CARTELLE SU CASSETTO CLASSIFICATORE VEDI PAG.31 for scheme for using folders in file-drawer, please see page 31				
MOBILE MEDIO L.90 CON 2 CASSETTI CLASSIFICATORI+2 ANTE LEGNO CON SERR. medium cabinet w 90 cms with 2 file-drawers+2 wooden doors with lock  L.90 x p.46,3 x H.158,3	L.90	114 865 (*)	83	0,490	5	€ 459,00	VERSIONE BI-COLORE / double-color version				
							(*)	FRONTALI	STRUTTURA	fronts	structure
								003	ROVERE	ARGENTO GOLF	oak
							004	ROVERE GREY	ARGENTO GOLF	grey oak	golf silver
							015	ACERO TAKI	ARGENTO GOLF	taki maple	golf silver
							025	GRIGIO	ARGENTO GOLF	grey	golf silver
							030	WENGE'	ARGENTO GOLF	wenge	golf silver
							040	BIANCO BR.	ARGENTO GOLF	br. white	golf silver
							044	STONE GREY	ARGENTO GOLF	stone grey	golf silver
							051	ANTRACITE	ARGENTO GOLF	anthracite	golf silver
							066	NOCE PAVIA	ARGENTO GOLF	pavia walnut	golf silver
							403	ROVERE	BIANCO BR.	oak	br. white
							404	ROVERE GREY	BIANCO BR.	grey oak	br. white
							405	ARGENTO GOLF	BIANCO BR.	golf silver	br. white
							415	ACERO TAKI	BIANCO BR.	taki maple	br. white
							430	WENGE'	BIANCO BR.	wenge	br. white
							444	STONE GREY	BIANCO BR.	stone grey	br. white
							451	ANTRACITE	BIANCO BR.	anthracite	br. white
							466	NOCE PAVIA	BIANCO BR.	pavia walnut	br. white
							503	ROVERE	ANTRACITE	oak	anthracite
							504	ROVERE GREY	ANTRACITE	grey oak	anthracite
							506	ARGENTO GOLF	ANTRACITE	golf silver	anthracite
							516	ACERO TAKI	ANTRACITE	taki maple	anthracite
							531	WENGE'	ANTRACITE	wenge	anthracite
							541	BIANCO BR.	ANTRACITE	br. white	anthracite
							544	STONE GREY	ANTRACITE	stone grey	anthracite
							566	NOCE PAVIA	ANTRACITE	pavia walnut	anthracite
							803	ROVERE	STONE GREY	oak	stone grey
							804	ROVERE GREY	STONE GREY	grey oak	stone grey
							805	ARGENTO GOLF	STONE GREY	golf silver	stone grey
							815	ACERO TAKI	STONE GREY	taki maple	stone grey
							830	WENGE'	STONE GREY	wenge	stone grey
							840	BIANCO BR.	STONE GREY	br. white	stone grey
							851	ANTRACITE	STONE GREY	anthracite	stone grey
							866	NOCE PAVIA	STONE GREY	pavia walnut	stone grey
MOBILE MEDIO L.90 CON 2 ANTE LEGNO CON SERRATURA medium cabinet w 90 cms with 2 wooden doors with lock  L.90 x p.46,3 x H.158,3	L.90	114 868 (*)	77	0,212	6	€ 313,00	(*)	STRUTTURA	structure		
							005	ARGENTO GOLF	golf silver		
							166	NOCE PAVIA	pavia walnut		
							440	BIANCO BR.	br. white		
							551	ANTRACITE	anthracite		
							844	STONE GREY	stone grey		
MOBILE MEDIO L.90 CON 2 ANTE LEGNO CON SERRATURA medium cabinet w 90 cms with 2 wooden doors with lock  L.90 x p.46,3 x H.158,3	L.90	114 869 (*)	77	0,199	4	€ 290,00	(*)	STRUTTURA	structure		
							005	ARGENTO GOLF	golf silver		
							166	NOCE PAVIA	pavia walnut		
							440	BIANCO BR.	br. white		
							551	ANTRACITE	anthracite		
							844	STONE GREY	stone grey		
MOBILE MEDIO L.90 CON 2 ANTE VETRO CON SERRATURA medium cabinet w 90 cms with 2 glass doors with lock  L.90 x p.46,3 x H.158,3	L.90	114 874 (*)	80	0,218	6	€ 470,00	(*)	STRUTTURA	structure		
							005	ARGENTO GOLF	golf silver		
							166	NOCE PAVIA	pavia walnut		
							440	BIANCO BR.	br. white		
							551	ANTRACITE	anthracite		
							844	STONE GREY	stone grey		
							MOBILI FORNITI CON ANTE: TELAIO ALLUMINIO E VETRO TEMPERATO SATINATO supplied cabinets with doors: aluminium frame and tempered satined glass				

CONTENITORI UNIVERSALI EVO  
universal cabinets EVO





DESCRIZIONE description		L w	CODICE code	KG	M <sup>3</sup>	COLLI	PREZZO price	(*) CODICE FINITURA (*) finish code			
<p>MOBILE ALTO A GIORNO L.45 open high cabinet w 45 cms</p> <p>ART. 825 ART. 828 ART. 826 ART. 829</p>		<p><b>CARCASSA PER ANTE INTERE SOLO LEGNO</b> structure for whole wooden doors only</p>									
		L.45	114 <b>825</b> (*)	49	0,104	3	€ 166,00				
		<p><b>CARCASSA PER ANTE SPEZZATE LEGNO E TUTTE LE TIPOLOGIE DI ANTE VETRO</b> structure for split wooden doors and all types glass doors</p>									
		L.45	114 <b>826</b> (*)	49	0,104	3	€ 166,00				
		<p><b>CARCASSA PER ANTE INTERE SOLO LEGNO</b> structure for whole wooden doors only</p>									
		<p>PROF. CM 35 depth 35 cms</p>				<p>● = COLORI DISPONIBILI available colours</p>					
		L.45	114 <b>828</b> (*)	45	0,097	3	€ 139,00				
		<p><b>CARCASSA PER ANTE SPEZZATE LEGNO E TUTTE LE TIPOLOGIE DI ANTE VETRO</b> structure for split wooden doors and all types glass doors</p>									
		<p>PROF. CM 35 depth 35 cms</p>				<p>● = COLORI DISPONIBILI available colours</p>					
		L.45	114 <b>829</b> (*)	45	0,097	3	€ 139,00				
L.45 x p.44,5 x H.196,7											
MOBILE ALTO L.45 CON 1 ANTA BASSA LEGNO CON SERRATURA high cabinet w 45 cms with 1 low wooden door with lock											
<p>Fig.DX/right</p>		<p>VERSIONE MONO-COLORE / single-color version</p>									
L.45 x p.46,3 x H.196,7	DX right	L.45	114 <b>875</b> (*)	54	0,126	4	€ 197,00	(*)			
	SX left	L.45	114 <b>876</b> (*)								
MOBILE ALTO L.45 CON 2 ANTE LEGNO CON SERRATURE high cabinet w 45 cms with 2 wooden doors with locks											
<p>Fig.DX/right</p>		<p>VERSIONE BI-COLORE / double-color version</p>									
L.45 x p.46,3 x H.196,7	DX right	L.45	114 <b>877</b> (*)	61	0,157	5	€ 235,00	(*) ANTE	STRUTTURA		
	SX left	L.45	114 <b>878</b> (*)					doors	structure		
MOBILE ALTO L.45 CON 1 ANTA BASSA LEGNO E 1 ANTA VETRO CON SERRATURE high cabinet w 45 cms with 1 low wooden door and 1 glass door with locks											
<p>Fig.DX/right</p>		<p>MOBILE FORNITO CON ANTA: <b>TELAIO ALLUMINIO E VETRO TEMPERATO SATINATO</b> supplied cabinet with door: <b>aluminium frame and tempered satined glass</b></p>									
L.45 x p.46,3 x H.196,7	DX right	L.45	114 <b>879</b> (*)	63	0,160	6	€ 304,00				
	SX left	L.45	114 <b>880</b> (*)								
		<p>005 ARGENTO GOLF golf silver</p> <p>166 NOCE PAVIA pavia walnut</p> <p>440 BIANCO BR. br. white</p> <p>551 ANTRACITE anthracite</p> <p>844 STONE GREY stone grey</p>									
		<p>003 ROVERE ARGENTO GOLF oak golf silver</p> <p>004 ROVERE GREY ARGENTO GOLF grey oak golf silver</p> <p>015 ACERO TAKI ARGENTO GOLF taki maple golf silver</p> <p>025 GRIGIO ARGENTO GOLF grey golf silver</p> <p>030 WENGHE' ARGENTO GOLF wenge golf silver</p> <p>040 BIANCO BR. ARGENTO GOLF br. white golf silver</p> <p>044 STONE GREY ARGENTO GOLF stone grey golf silver</p> <p>051 ANTRACITE ARGENTO GOLF anthracite golf silver</p> <p>066 NOCE PAVIA ARGENTO GOLF pavia walnut golf silver</p> <p>403 ROVERE BIANCO BR. oak br. white</p> <p>404 ROVERE GREY BIANCO BR. grey oak br. white</p> <p>405 ARGENTO GOLF BIANCO BR. golf silver br. white</p> <p>415 ACERO TAKI BIANCO BR. taki maple br. white</p> <p>430 WENGHE' BIANCO BR. wenge br. white</p> <p>444 STONE GREY BIANCO BR. stone grey br. white</p> <p>451 ANTRACITE BIANCO BR. anthracite br. white</p> <p>466 NOCE PAVIA BIANCO BR. pavia walnut br. white</p> <p>503 ROVERE ANTRACITE oak anthracite</p> <p>504 ROVERE GREY ANTRACITE grey oak anthracite</p> <p>506 ARGENTO GOLF ANTRACITE golf silver anthracite</p> <p>516 ACERO TAKI ANTRACITE taki maple anthracite</p> <p>531 WENGHE' ANTRACITE wenge anthracite</p> <p>541 BIANCO BR. ANTRACITE br. white anthracite</p> <p>544 STONE GREY ANTRACITE stone grey anthracite</p> <p>566 NOCE PAVIA ANTRACITE pavia walnut anthracite</p> <p>803 ROVERE STONE GREY oak stone grey</p> <p>804 ROVERE GREY STONE GREY grey oak stone grey</p> <p>805 ARGENTO GOLF STONE GREY golf silver stone grey</p> <p>815 ACERO TAKI STONE GREY taki maple stone grey</p> <p>830 WENGHE' STONE GREY wenge stone grey</p> <p>840 BIANCO BR. STONE GREY br. white stone grey</p> <p>851 ANTRACITE STONE GREY anthracite stone grey</p> <p>866 NOCE PAVIA STONE GREY pavia walnut stone grey</p>									

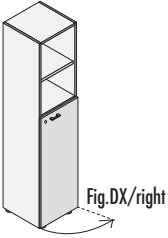
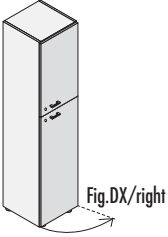
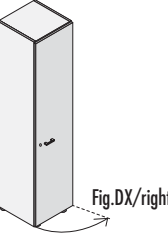
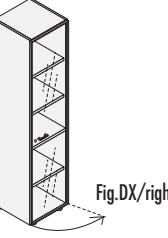

**CONTENITORI ALTI H.196,7**  
*high cabinets h. 196,7 cms*

UTILIZZABILI ANCHE SENZA TOP DI FINITURA (VEDI PAG. 30)  
can also be used without finishing top (please see page 30)

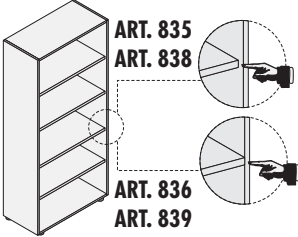
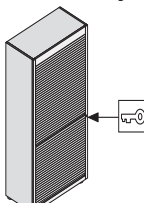
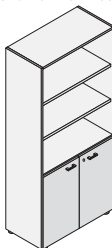
DESCRIZIONE <i>description</i>	L <i>w</i>	CODICE <i>code</i>	KG	M <sup>3</sup>	COLLI	PREZZO <i>price</i>	(*) CODICE FINITURA <i>(*) finish code</i>							
MOBILE ALTO L.45 CON 1 ANTA LEGNO CON SERRATURA <i>high cabinet w 45 cms with 1 wooden door with lock</i>   Fig.DX/right  L.45 x p.46,3 x H.196,7	DX <i>right</i>	L.45	114 881 (*)	56	0,135	4	€ 204,00	VERSIONE MONO-COLORE / <i>single-color version</i>						
	SX <i>left</i>	L.45	114 882 (*)					(*)	ANTE	STRUTTURA	<i>doors</i>	<i>structure</i>		
								005	ARGENTO GOLF	golf silver				
								166	NOCE PAVIA	pavia walnut				
								440	BIANCO BR.	br. white				
								551	ANTRACITE	anthracite				
								844	STONE GREY	stone grey				
								VERSIONE BI-COLORE / <i>double-color version</i>						
								(*)	ANTE	STRUTTURA	<i>doors</i>	<i>structure</i>		
								003	ROVERE	ARGENTO GOLF	oak	golf silver		
								004	ROVERE GREY	ARGENTO GOLF	grey oak	golf silver		
								015	ACERO TAKI	ARGENTO GOLF	taki maple	golf silver		
								025	GRIGIO	ARGENTO GOLF	grey	golf silver		
								030	WENGE'	ARGENTO GOLF	wenge	golf silver		
								040	BIANCO BR.	ARGENTO GOLF	br. white	golf silver		
								044	STONE GREY	ARGENTO GOLF	stone grey	golf silver		
								051	ANTRACITE	ARGENTO GOLF	anthracite	golf silver		
								066	NOCE PAVIA	ARGENTO GOLF	pavia walnut	golf silver		
								403	ROVERE	BIANCO BR.	oak	br. white		
								404	ROVERE GREY	BIANCO BR.	grey oak	br. white		
								405	ARGENTO GOLF	BIANCO BR.	golf silver	br. white		
								415	ACERO TAKI	BIANCO BR.	taki maple	br. white		
								430	WENGE'	BIANCO BR.	wenge	br. white		
								444	STONE GREY	BIANCO BR.	stone grey	br. white		
								451	ANTRACITE	BIANCO BR.	anthracite	br. white		
								466	NOCE PAVIA	BIANCO BR.	pavia walnut	br. white		
								503	ROVERE	ANTRACITE	oak	anthracite		
								504	ROVERE GREY	ANTRACITE	grey oak	anthracite		
								506	ARGENTO GOLF	ANTRACITE	golf silver	anthracite		
								516	ACERO TAKI	ANTRACITE	taki maple	anthracite		
								531	WENGE'	ANTRACITE	wenge	anthracite		
								541	BIANCO BR.	ANTRACITE	br. white	anthracite		
								544	STONE GREY	ANTRACITE	stone grey	anthracite		
								566	NOCE PAVIA	ANTRACITE	pavia walnut	anthracite		
								803	ROVERE	STONE GREY	oak	stone grey		
								804	ROVERE GREY	STONE GREY	grey oak	stone grey		
								805	ARGENTO GOLF	STONE GREY	golf silver	stone grey		
								815	ACERO TAKI	STONE GREY	taki maple	stone grey		
								830	WENGE'	STONE GREY	wenge	stone grey		
								840	BIANCO BR.	STONE GREY	br. white	stone grey		
								851	ANTRACITE	STONE GREY	anthracite	stone grey		
								866	NOCE PAVIA	STONE GREY	pavia walnut	stone grey		
MOBILE ALTO L.45 CON 2 ANTE LEGNO CON SERRATURE <i>high cabinet w 45 cms with 2 wooden doors with locks</i>   Fig.DX/right  L.45 x p.46,3 x H.196,7	DX <i>right</i>	L.45	114 883 (*)	61	0,157	5	€ 235,00							
	SX <i>left</i>	L.45	114 884 (*)					(*)	ANTE	STRUTTURA	<i>doors</i>	<i>structure</i>		
								003	ROVERE	ARGENTO GOLF	oak	golf silver		
								004	ROVERE GREY	ARGENTO GOLF	grey oak	golf silver		
								015	ACERO TAKI	ARGENTO GOLF	taki maple	golf silver		
								025	GRIGIO	ARGENTO GOLF	grey	golf silver		
								030	WENGE'	ARGENTO GOLF	wenge	golf silver		
								040	BIANCO BR.	ARGENTO GOLF	br. white	golf silver		
								044	STONE GREY	ARGENTO GOLF	stone grey	golf silver		
								051	ANTRACITE	ARGENTO GOLF	anthracite	golf silver		
								066	NOCE PAVIA	ARGENTO GOLF	pavia walnut	golf silver		
								403	ROVERE	BIANCO BR.	oak	br. white		
								404	ROVERE GREY	BIANCO BR.	grey oak	br. white		
								405	ARGENTO GOLF	BIANCO BR.	golf silver	br. white		
								415	ACERO TAKI	BIANCO BR.	taki maple	br. white		
								430	WENGE'	BIANCO BR.	wenge	br. white		
								444	STONE GREY	BIANCO BR.	stone grey	br. white		
								451	ANTRACITE	BIANCO BR.	anthracite	br. white		
								466	NOCE PAVIA	BIANCO BR.	pavia walnut	br. white		
								503	ROVERE	ANTRACITE	oak	anthracite		
								504	ROVERE GREY	ANTRACITE	grey oak	anthracite		
								506	ARGENTO GOLF	ANTRACITE	golf silver	anthracite		
								516	ACERO TAKI	ANTRACITE	taki maple	anthracite		
								531	WENGE'	ANTRACITE	wenge	anthracite		
								541	BIANCO BR.	ANTRACITE	br. white	anthracite		
								544	STONE GREY	ANTRACITE	stone grey	anthracite		
								566	NOCE PAVIA	ANTRACITE	pavia walnut	anthracite		
								803	ROVERE	STONE GREY	oak	stone grey		
								804	ROVERE GREY	STONE GREY	grey oak	stone grey		
								805	ARGENTO GOLF	STONE GREY	golf silver	stone grey		
								815	ACERO TAKI	STONE GREY	taki maple	stone grey		
								830	WENGE'	STONE GREY	wenge	stone grey		
								840	BIANCO BR.	STONE GREY	br. white	stone grey		
								851	ANTRACITE	STONE GREY	anthracite	stone grey		
								866	NOCE PAVIA	STONE GREY	pavia walnut	stone grey		
MOBILE ALTO L.45 CON 1 ANTA LEGNO CON SERRATURA <i>high cabinet w 45 cms with 1 wooden door with lock</i>   Fig.DX/right  L.45 x p.46,3 x H.196,7	DX <i>right</i>	L.45	114 885 (*)	61	0,171	4	€ 245,00							
	SX <i>left</i>	L.45	114 886 (*)					(*)	ANTE	STRUTTURA	<i>doors</i>	<i>structure</i>		
								003	ROVERE	ARGENTO GOLF	oak	golf silver		
								004	ROVERE GREY	ARGENTO GOLF	grey oak	golf silver		
								015	ACERO TAKI	ARGENTO GOLF	taki maple	golf silver		
								025	GRIGIO	ARGENTO GOLF	grey	golf silver		
								030	WENGE'	ARGENTO GOLF	wenge	golf silver		
								040	BIANCO BR.	ARGENTO GOLF	br. white	golf silver		
								044	STONE GREY	ARGENTO GOLF	stone grey	golf silver		
								051	ANTRACITE	ARGENTO GOLF	anthracite	golf silver		
								066	NOCE PAVIA	ARGENTO GOLF	pavia walnut	golf silver		
								403	ROVERE	BIANCO BR.	oak	br. white		
								404	ROVERE GREY	BIANCO BR.	grey oak	br. white		
								405	ARGENTO GOLF	BIANCO BR.	golf silver	br. white		
								415	ACERO TAKI	BIANCO BR.	taki maple	br. white		
								430	WENGE'	BIANCO BR.	wenge	br. white		
								444	STONE GREY	BIANCO BR.	stone grey	br. white		
								451	ANTRACITE	BIANCO BR.	anthracite	br. white		
								466	NOCE PAVIA	BIANCO BR.	pavia walnut	br. white		
								503	ROVERE	ANTRACITE	oak	anthracite		
								504	ROVERE GREY	ANTRACITE	grey oak	anthracite		
								506	ARGENTO GOLF	ANTRACITE	golf silver	anthracite		
								516	ACERO TAKI	ANTRACITE	taki maple	anthracite		
								531	WENGE'	ANTRACITE	wenge	anthracite		
								541	BIANCO BR.	ANTRACITE	br. white	anthracite		
								544	STONE GREY	ANTRACITE	stone grey	anthracite		
								566	NOCE PAVIA	ANTRACITE	pavia walnut	anthracite		
								803	ROVERE	STONE GREY	oak	stone grey		
								804	ROVERE GREY	STONE GREY	grey oak	stone grey		
								805	ARGENTO GOLF	STONE GREY	golf silver	stone grey		
								815	ACERO TAKI	STONE GREY	taki maple	stone grey		
								830	WENGE'	STONE GREY	wenge	stone grey		
								840	BIANCO BR.	STONE GREY	br. white	stone grey		
								851	ANTRACITE	STONE GREY	anthracite	stone grey		
								866	NOCE PAVIA	STONE GREY	pavia walnut	stone grey		
MOBILE ALTO L.45 CON 1 ANTA VETRO CON SERRATURA <i>high cabinet w 45 cms with 1 glass door with lock</i>   Fig.DX/right  L.45 x p.46,3 x H.196,7	DX <i>right</i>	L.45	114 887 (*)	64	0,156	5	€ 313,00							
	SX <i>left</i>	L.45	114 888 (*)					(*)	STRUTTURA	<i>structure</i>				
								005	ARGENTO GOLF	golf silver				
								166	NOCE PAVIA	pavia walnut				
								440	BIANCO BR.	br. white				
								551	ANTRACITE	anthracite				
								844	STONE GREY	stone grey				
								MOBILI FORNITI CON ANTA: <b>TELAIO ALLUMINIO E VETRO TEMPERATO SATINATO</b> <i>supplied cabinets with door: aluminium frame and tempered satined glass</i>						

DESCRIZIONE description		L w	CODICE code	KG	M <sup>3</sup>	COLLI	PREZZO price	(*) CODICE FINITURA (*) finish code				
<b>MOBILE ALTO A GIORNO L.90</b> open high cabinet w 90 cms   ART. 835 ART. 838  ART. 836 ART. 839  L.90 x p.44,5 x H.196,7		<b>CARCASSA PER ANTE INTERE SOLO LEGNO</b> structure for whole wooden doors only										
		L.90	114 835 (*)	73	0,162	3	€ 242,00					
		<b>CARCASSA PER ANTE SPEZZATE LEGNO E TUTTE LE TIPOLOGIE DI ANTE VETRO</b> structure for split wooden doors and all types glass doors										
		L.90	114 836 (*)	73	0,162	3	€ 242,00	(*)	STRUTTURA	structure		
		<b>CARCASSA PER ANTE INTERE SOLO LEGNO</b> structure for whole wooden doors only										
		PROF. CM 35 depth 35 cms		● = COLORI DISPONIBILI available colours						005	ARGENTO GOLF	golf silver
		L.90	114 838 (*)	68	0,148	3	€ 214,00	166	NOCE PAVIA	pavia walnut		
		<b>CARCASSA PER ANTE SPEZZATE LEGNO E TUTTE LE TIPOLOGIE DI ANTE VETRO</b> structure for split wooden doors and all types glass doors										
		PROF. CM 35 depth 35 cms		● = COLORI DISPONIBILI available colours						440	BIANCO BR.	br. white
		L.90	114 839 (*)	68	0,148	3	€ 214,00	551	ANTRACITE	anthracite		
								844	STONE GREY	stone grey		
<b>MOBILE ALTO L.90 CON SERRANDINA CON SERRATURA</b> high cabinet w 90 cms with rolling shutter with lock												
												
L.90 x p.46,3 x H.196,7		L.90	114 840 (*)	87	0,233	5	€ 595,00	(*)	STRUTTURA	structure		
								005	ARGENTO GOLF	golf silver		
								166	NOCE PAVIA	pavia walnut		
								440	BIANCO BR.	br. white		
								551	ANTRACITE	anthracite		
								844	STONE GREY	stone grey		
								SERRANDINA ARGENTO METALLIZZATO metallic silver rolling shutter				
<b>MOBILE ALTO L.90 CON 2 ANTE BASSE LEGNO CON SERR.</b> high cabinet w 90 cms with 2 low wooden doors with lock												
												
L.90 x p.46,3 x H.196,7		L.90	114 889 (*)	83	0,195	4	€ 294,00	VERSIONE MONO-COLORE / single-color version				
								(*)				
								005	ARGENTO GOLF	golf silver		
								166	NOCE PAVIA	pavia walnut		
								440	BIANCO BR.	br. white		
								551	ANTRACITE	anthracite		
								844	STONE GREY	stone grey		
								VERSIONE BI-COLORE / double-color version				
								(*)	ANTE	STRUTTURA	doors	structure
								003	ROVERE	ARGENTO GOLF	oak	golf silver
								004	ROVERE GREY	ARGENTO GOLF	grey oak	golf silver
								015	ACERO TAKI	ARGENTO GOLF	taki maple	golf silver
								025	GRIGIO	ARGENTO GOLF	grey	golf silver
								030	WENGE'	ARGENTO GOLF	wenge	golf silver
								040	BIANCO BR.	ARGENTO GOLF	br. white	golf silver
								044	STONE GREY	ARGENTO GOLF	stone grey	golf silver
								051	ANTRACITE	ARGENTO GOLF	anthracite	golf silver
								066	NOCE PAVIA	ARGENTO GOLF	pavia walnut	golf silver
								403	ROVERE	BIANCO BR.	oak	br. white
								404	ROVERE GREY	BIANCO BR.	grey oak	br. white
								405	ARGENTO GOLF	BIANCO BR.	golf silver	br. white
								415	ACERO TAKI	BIANCO BR.	taki maple	br. white
								430	WENGE'	BIANCO BR.	wenge	br. white
								444	STONE GREY	BIANCO BR.	stone grey	br. white
								451	ANTRACITE	BIANCO BR.	anthracite	br. white
								466	NOCE PAVIA	BIANCO BR.	pavia walnut	br. white
								503	ROVERE	ANTRACITE	oak	anthracite
								504	ROVERE GREY	ANTRACITE	grey oak	anthracite
								506	ARGENTO GOLF	ANTRACITE	golf silver	anthracite
								516	ACERO TAKI	ANTRACITE	taki maple	anthracite
								531	WENGE'	ANTRACITE	wenge	anthracite
								541	BIANCO BR.	ANTRACITE	br. white	anthracite
								544	STONE GREY	ANTRACITE	stone grey	anthracite
								566	NOCE PAVIA	ANTRACITE	pavia walnut	anthracite
								803	ROVERE	STONE GREY	oak	stone grey
								804	ROVERE GREY	STONE GREY	grey oak	stone grey
								805	ARGENTO GOLF	STONE GREY	golf silver	stone grey
								815	ACERO TAKI	STONE GREY	taki maple	stone grey
								830	WENGE'	STONE GREY	wenge	stone grey
								840	BIANCO BR.	STONE GREY	br. white	stone grey
								851	ANTRACITE	STONE GREY	anthracite	stone grey
								866	NOCE PAVIA	STONE GREY	pavia walnut	stone grey
<b>MOBILE ALTO L.90 CON 2 ANTE BASSE LEGNO E 2 ANTE VETRO CON SERR.</b> high cabinet w 90 cms with 2 low wooden doors and 2 glass doors with lock												
												
L.90 x p.46,3 x H.196,7		L.90	114 892 (*)	100	0,260	7	€ 504,00	MOBILE FORNITO CON ANTE: <b>TELAIO ALLUMINIO E VETRO TEMPERATO SATINATO</b> supplied cabinet with doors: <b>aluminium frame and tempered satined glass</b>				

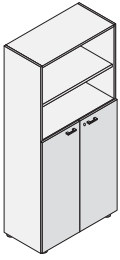
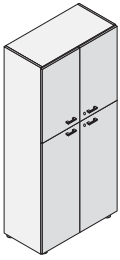
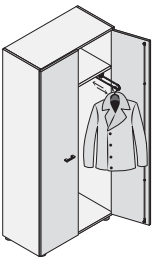
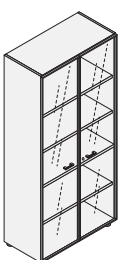

DESCRIZIONE <i>description</i>		L w	CODICE code	KG	M <sup>3</sup>	COLLI	PREZZO price	(*) CODICE FINITURA (*) finish code		
<b>MOBILE ALTO L.90 CON 2 ANTE LEGNO CON SERRATURA</b> <i>high cabinet w 90 cms with 2 wooden doors with lock</i>  <p>L.90 x p.46,3 x H.196,7</p>		L.90	<b>114 893 (*)</b>	87	0,211	4	<b>€ 308,00</b>	VERSIONE MONO-COLORE / <i>single-color version</i>		
								(*)		
								005	ARGENTO GOLF / <i>golf silver</i>	
								166	NOCE PAVIA / <i>pavia walnut</i>	
								440	BIANCO BR. / <i>br. white</i>	
								551	ANTRACITE / <i>anthracite</i>	
								844	STONE GREY / <i>stone grey</i>	
<b>MOBILE ALTO L.90 CON 4 ANTE LEGNO CON SERRATURA</b> <i>high cabinet w 90 cms with 4 wooden doors with lock</i>  <p>L.90 x p.46,3 x H.196,7</p>		L.90	<b>114 894 (*)</b>	97	0,255	6	<b>€ 364,00</b>	VERSIONE BI-COLORE / <i>double-color version</i>		
								(*)	ANTE STRUTTURA / <i>doors structure</i>	
								003	ROVERE ARGENTO GOLF / <i>oak golf silver</i>	
								004	ROVERE GREY ARGENTO GOLF / <i>grey oak golf silver</i>	
								015	ACERO TAKI ARGENTO GOLF / <i>taki maple golf silver</i>	
								025	GRIGIO ARGENTO GOLF / <i>grey golf silver</i>	
								030	WENGE' ARGENTO GOLF / <i>wenge golf silver</i>	
								040	BIANCO BR. ARGENTO GOLF / <i>br. white golf silver</i>	
								044	STONE GREY ARGENTO GOLF / <i>stone grey golf silver</i>	
								051	ANTRACITE ARGENTO GOLF / <i>anthracite golf silver</i>	
								066	NOCE PAVIA ARGENTO GOLF / <i>pavia walnut golf silver</i>	
								403	ROVERE BIANCO BR. / <i>oak br. white</i>	
								404	ROVERE GREY BIANCO BR. / <i>grey oak br. white</i>	
								405	ARGENTO GOLF BIANCO BR. / <i>golf silver br. white</i>	
								415	ACERO TAKI BIANCO BR. / <i>taki maple br. white</i>	
								430	WENGE' BIANCO BR. / <i>wenge br. white</i>	
								444	STONE GREY BIANCO BR. / <i>stone grey br. white</i>	
								451	ANTRACITE BIANCO BR. / <i>anthracite br. white</i>	
								466	NOCE PAVIA BIANCO BR. / <i>pavia walnut br. white</i>	
								503	ROVERE ANTRACITE / <i>oak anthracite</i>	
								504	ROVERE GREY ANTRACITE / <i>grey oak anthracite</i>	
								506	ARGENTO GOLF ANTRACITE / <i>golf silver anthracite</i>	
								516	ACERO TAKI ANTRACITE / <i>taki maple anthracite</i>	
								531	WENGE' ANTRACITE / <i>wenge anthracite</i>	
								541	BIANCO BR. ANTRACITE / <i>br. white anthracite</i>	
								544	STONE GREY ANTRACITE / <i>stone grey anthracite</i>	
								566	NOCE PAVIA ANTRACITE / <i>pavia walnut anthracite</i>	
								803	ROVERE STONE GREY / <i>oak stone grey</i>	
								804	ROVERE GREY STONE GREY / <i>grey oak stone grey</i>	
								805	ARGENTO GOLF STONE GREY / <i>golf silver stone grey</i>	
								815	ACERO TAKI STONE GREY / <i>taki maple stone grey</i>	
								830	WENGE' STONE GREY / <i>wenge stone grey</i>	
								840	BIANCO BR. STONE GREY / <i>br. white stone grey</i>	
								851	ANTRACITE STONE GREY / <i>anthracite stone grey</i>	
								866	NOCE PAVIA STONE GREY / <i>pavia walnut stone grey</i>	
<b>MOBILE ALTO L.90 CON 2 ANTE LEGNO CON SERRATURA</b> <b>E 2 APPENDIABITI ESTRAIBILI</b> <i>high cabinet w 90 cms with 2 wooden doors with lock and 2 pull-out clothes-hanger rails</i>  <p>L.90 x p.46,3 x H.196,7</p>		L.90	<b>114 896 (*)</b>	82	0,210	4	<b>€ 341,00</b>			
<b>MOBILE ALTO L.90 CON 2 ANTE VETRO CON SERRATURA</b> <i>high cabinet w 90 cms with 2 glass doors with lock</i>  <p>L.90 x p.46,3 x H.196,7</p>		L.90	<b>114 897 (*)</b>	102	0,266	6	<b>€ 538,00</b>	(*)		
								005	ARGENTO GOLF / <i>golf silver</i>	
								166	NOCE PAVIA / <i>pavia walnut</i>	
								440	BIANCO BR. / <i>br. white</i>	
								551	ANTRACITE / <i>anthracite</i>	
								844	STONE GREY / <i>stone grey</i>	
		MOBILI FORNITI CON ANTE: <b>TELAIO ALLUMINIO E VETRO TEMPERATO SATINATO</b> <i>supplied cabinets with doors: aluminium frame and tempered satined glass</i>								

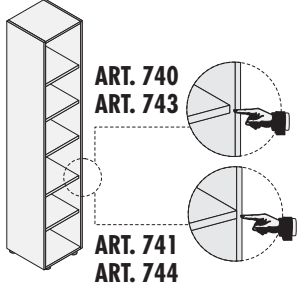
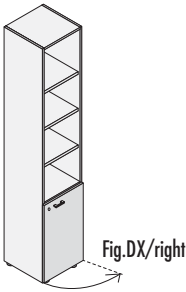
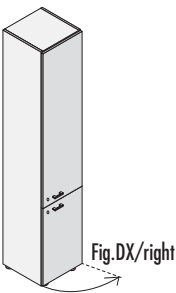
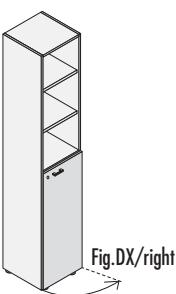
CONTENITORI ALTI H.235 high cabinets h. 235 cms		(KIT FISSAGGIO A MURO INCLUSO) (wall fixing kit included)				UTILIZZABILI ANCHE SENZA TOP DI FINITURA (VEDI PAG. 30) can also be used without finishing top (please see page 30)																																																																																																																																																																											
DESCRIZIONE description	L w	CODICE code	KG	M <sup>3</sup>	COLLI	PREZZO price	(*) CODICE FINITURA (* finish code)																																																																																																																																																																										
MOBILE ALTO A GIORNO L.45 open high cabinet w 45 cms  	<b>CARCASSA PER ANTE INTERE SOLO LEGNO</b> structure for whole wooden doors only																																																																																																																																																																																
	L.45	114 740 (*)	59	0,133	5	€ 211,00																																																																																																																																																																											
	<b>CARCASSA PER ANTE SPEZZATE LEGNO E TUTTE LE TIPOLOGIE DI ANTE VETRO</b> structure for split wooden doors and all types glass doors																																																																																																																																																																																
	L.45	114 741 (*)	59	0,133	5	€ 211,00																																																																																																																																																																											
	<b>CARCASSA PER ANTE INTERE SOLO LEGNO</b> structure for whole wooden doors only																																																																																																																																																																																
		PROF. CM 35 depth 35 cms	● = COLORI DISPONIBILI available colours																																																																																																																																																																														
	L.45	114 743 (*)	55	0,126	5	€ 186,00																																																																																																																																																																											
	<b>CARCASSA PER ANTE SPEZZATE LEGNO E TUTTE LE TIPOLOGIE DI ANTE VETRO</b> structure for split wooden doors and all types glass doors																																																																																																																																																																																
		PROF. CM 35 depth 35 cms	● = COLORI DISPONIBILI available colours																																																																																																																																																																														
	L.45	114 744 (*)	55	0,126	5	€ 186,00																																																																																																																																																																											
L.45 x p.44,5 x H.235							<table border="1"> <thead> <tr> <th>(*)</th> <th>STRUTTURA</th> <th>structure</th> </tr> </thead> <tbody> <tr> <td>005</td> <td>ARGENTO GOLF</td> <td>golf silver</td> </tr> <tr> <td>166</td> <td>NOCE PAVIA</td> <td>pavia walnut</td> </tr> <tr> <td>440</td> <td>BIANCO BR.</td> <td>br. white</td> </tr> <tr> <td>551</td> <td>ANTRACITE</td> <td>anthracite</td> </tr> <tr> <td>844</td> <td>STONE GREY</td> <td>stone grey</td> </tr> </tbody> </table>	(*)	STRUTTURA	structure	005	ARGENTO GOLF	golf silver	166	NOCE PAVIA	pavia walnut	440	BIANCO BR.	br. white	551	ANTRACITE	anthracite	844	STONE GREY	stone grey																																																																																																																																																								
(*)	STRUTTURA	structure																																																																																																																																																																															
005	ARGENTO GOLF	golf silver																																																																																																																																																																															
166	NOCE PAVIA	pavia walnut																																																																																																																																																																															
440	BIANCO BR.	br. white																																																																																																																																																																															
551	ANTRACITE	anthracite																																																																																																																																																																															
844	STONE GREY	stone grey																																																																																																																																																																															
MOBILE ALTO L.45 CON 1 ANTA BASSA LEGNO CON SERRATURA high cabinet w 45 cms with 1 low wooden door with lock  	VERSIONE MONO-COLORE / single-color version																																																																																																																																																																																
	<b>(*)</b>																																																																																																																																																																																
		005	ARGENTO GOLF			golf silver																																																																																																																																																																											
		166	NOCE PAVIA			pavia walnut																																																																																																																																																																											
		440	BIANCO BR.			br. white																																																																																																																																																																											
		551	ANTRACITE			anthracite																																																																																																																																																																											
		844	STONE GREY			stone grey																																																																																																																																																																											
	DX right	L.45	114 761 (*)	64	0,155	6	€ 242,00	VERSIONE BI-COLORE / double-color version																																																																																																																																																																									
	SX left	L.45	114 762 (*)																																																																																																																																																																														
	L.45 x p.46,3 x H.235							<table border="1"> <thead> <tr> <th>(*)</th> <th>ANTE</th> <th>STRUTTURA</th> <th>doors</th> <th>structure</th> </tr> </thead> <tbody> <tr> <td>003</td> <td>ROVERE</td> <td>ARGENTO GOLF</td> <td>oak</td> <td>golf silver</td> </tr> <tr> <td>004</td> <td>ROVERE GREY</td> <td>ARGENTO GOLF</td> <td>grey oak</td> <td>golf silver</td> </tr> <tr> <td>015</td> <td>ACERO TAKI</td> <td>ARGENTO GOLF</td> <td>taki maple</td> <td>golf silver</td> </tr> <tr> <td>025</td> <td>GRIGIO</td> <td>ARGENTO GOLF</td> <td>grey</td> <td>golf silver</td> </tr> <tr> <td>030</td> <td>WENGE'</td> <td>ARGENTO GOLF</td> <td>wenge</td> <td>golf silver</td> </tr> <tr> <td>040</td> <td>BIANCO BR.</td> <td>ARGENTO GOLF</td> <td>br. white</td> <td>golf silver</td> </tr> <tr> <td>044</td> <td>STONE GREY</td> <td>ARGENTO GOLF</td> <td>stone grey</td> <td>golf silver</td> </tr> <tr> <td>051</td> <td>ANTRACITE</td> <td>ARGENTO GOLF</td> <td>anthracite</td> <td>golf silver</td> </tr> <tr> <td>066</td> <td>NOCE PAVIA</td> <td>ARGENTO GOLF</td> <td>pavia walnut</td> <td>golf silver</td> </tr> <tr> <td>403</td> <td>ROVERE</td> <td>BIANCO BR.</td> <td>oak</td> <td>br. white</td> </tr> <tr> <td>404</td> <td>ROVERE GREY</td> <td>BIANCO BR.</td> <td>grey oak</td> <td>br. white</td> </tr> <tr> <td>405</td> <td>ARGENTO GOLF</td> <td>BIANCO BR.</td> <td>golf silver</td> <td>br. white</td> </tr> <tr> <td>415</td> <td>ACERO TAKI</td> <td>BIANCO BR.</td> <td>taki maple</td> <td>br. white</td> </tr> <tr> <td>430</td> <td>WENGE'</td> <td>BIANCO BR.</td> <td>wenge</td> <td>br. white</td> </tr> <tr> <td>444</td> <td>STONE GREY</td> <td>BIANCO BR.</td> <td>stone grey</td> <td>br. white</td> </tr> <tr> <td>451</td> <td>ANTRACITE</td> <td>BIANCO BR.</td> <td>anthracite</td> <td>br. white</td> </tr> <tr> <td>466</td> <td>NOCE PAVIA</td> <td>BIANCO BR.</td> <td>pavia walnut</td> <td>br. white</td> </tr> <tr> <td>503</td> <td>ROVERE</td> <td>ANTRACITE</td> <td>oak</td> <td>anthracite</td> </tr> <tr> <td>504</td> <td>ROVERE GREY</td> <td>ANTRACITE</td> <td>grey oak</td> <td>anthracite</td> </tr> <tr> <td>506</td> <td>ARGENTO GOLF</td> <td>ANTRACITE</td> <td>golf silver</td> <td>anthracite</td> </tr> <tr> <td>516</td> <td>ACERO TAKI</td> <td>ANTRACITE</td> <td>taki maple</td> <td>anthracite</td> </tr> <tr> <td>531</td> <td>WENGE'</td> <td>ANTRACITE</td> <td>wenge</td> <td>anthracite</td> </tr> <tr> <td>541</td> <td>BIANCO BR.</td> <td>ANTRACITE</td> <td>br. white</td> <td>anthracite</td> </tr> <tr> <td>544</td> <td>STONE GREY</td> <td>ANTRACITE</td> <td>stone grey</td> <td>anthracite</td> </tr> <tr> <td>566</td> <td>NOCE PAVIA</td> <td>ANTRACITE</td> <td>pavia walnut</td> <td>anthracite</td> </tr> <tr> <td>803</td> <td>ROVERE</td> <td>STONE GREY</td> <td>oak</td> <td>stone grey</td> </tr> <tr> <td>804</td> <td>ROVERE GREY</td> <td>STONE GREY</td> <td>grey oak</td> <td>stone grey</td> </tr> <tr> <td>805</td> <td>ARGENTO GOLF</td> <td>STONE GREY</td> <td>golf silver</td> <td>stone grey</td> </tr> <tr> <td>815</td> <td>ACERO TAKI</td> <td>STONE GREY</td> <td>taki maple</td> <td>stone grey</td> </tr> <tr> <td>830</td> <td>WENGE'</td> <td>STONE GREY</td> <td>wenge</td> <td>stone grey</td> </tr> <tr> <td>840</td> <td>BIANCO BR.</td> <td>STONE GREY</td> <td>br. white</td> <td>stone grey</td> </tr> <tr> <td>851</td> <td>ANTRACITE</td> <td>STONE GREY</td> <td>anthracite</td> <td>stone grey</td> </tr> <tr> <td>866</td> <td>NOCE PAVIA</td> <td>STONE GREY</td> <td>pavia walnut</td> <td>stone grey</td> </tr> </tbody> </table>	(*)	ANTE	STRUTTURA	doors	structure	003	ROVERE	ARGENTO GOLF	oak	golf silver	004	ROVERE GREY	ARGENTO GOLF	grey oak	golf silver	015	ACERO TAKI	ARGENTO GOLF	taki maple	golf silver	025	GRIGIO	ARGENTO GOLF	grey	golf silver	030	WENGE'	ARGENTO GOLF	wenge	golf silver	040	BIANCO BR.	ARGENTO GOLF	br. white	golf silver	044	STONE GREY	ARGENTO GOLF	stone grey	golf silver	051	ANTRACITE	ARGENTO GOLF	anthracite	golf silver	066	NOCE PAVIA	ARGENTO GOLF	pavia walnut	golf silver	403	ROVERE	BIANCO BR.	oak	br. white	404	ROVERE GREY	BIANCO BR.	grey oak	br. white	405	ARGENTO GOLF	BIANCO BR.	golf silver	br. white	415	ACERO TAKI	BIANCO BR.	taki maple	br. white	430	WENGE'	BIANCO BR.	wenge	br. white	444	STONE GREY	BIANCO BR.	stone grey	br. white	451	ANTRACITE	BIANCO BR.	anthracite	br. white	466	NOCE PAVIA	BIANCO BR.	pavia walnut	br. white	503	ROVERE	ANTRACITE	oak	anthracite	504	ROVERE GREY	ANTRACITE	grey oak	anthracite	506	ARGENTO GOLF	ANTRACITE	golf silver	anthracite	516	ACERO TAKI	ANTRACITE	taki maple	anthracite	531	WENGE'	ANTRACITE	wenge	anthracite	541	BIANCO BR.	ANTRACITE	br. white	anthracite	544	STONE GREY	ANTRACITE	stone grey	anthracite	566	NOCE PAVIA	ANTRACITE	pavia walnut	anthracite	803	ROVERE	STONE GREY	oak	stone grey	804	ROVERE GREY	STONE GREY	grey oak	stone grey	805	ARGENTO GOLF	STONE GREY	golf silver	stone grey	815	ACERO TAKI	STONE GREY	taki maple	stone grey	830	WENGE'	STONE GREY	wenge	stone grey	840	BIANCO BR.	STONE GREY	br. white	stone grey	851	ANTRACITE	STONE GREY	anthracite	stone grey	866	NOCE PAVIA	STONE GREY	pavia walnut
(*)	ANTE	STRUTTURA	doors	structure																																																																																																																																																																													
003	ROVERE	ARGENTO GOLF	oak	golf silver																																																																																																																																																																													
004	ROVERE GREY	ARGENTO GOLF	grey oak	golf silver																																																																																																																																																																													
015	ACERO TAKI	ARGENTO GOLF	taki maple	golf silver																																																																																																																																																																													
025	GRIGIO	ARGENTO GOLF	grey	golf silver																																																																																																																																																																													
030	WENGE'	ARGENTO GOLF	wenge	golf silver																																																																																																																																																																													
040	BIANCO BR.	ARGENTO GOLF	br. white	golf silver																																																																																																																																																																													
044	STONE GREY	ARGENTO GOLF	stone grey	golf silver																																																																																																																																																																													
051	ANTRACITE	ARGENTO GOLF	anthracite	golf silver																																																																																																																																																																													
066	NOCE PAVIA	ARGENTO GOLF	pavia walnut	golf silver																																																																																																																																																																													
403	ROVERE	BIANCO BR.	oak	br. white																																																																																																																																																																													
404	ROVERE GREY	BIANCO BR.	grey oak	br. white																																																																																																																																																																													
405	ARGENTO GOLF	BIANCO BR.	golf silver	br. white																																																																																																																																																																													
415	ACERO TAKI	BIANCO BR.	taki maple	br. white																																																																																																																																																																													
430	WENGE'	BIANCO BR.	wenge	br. white																																																																																																																																																																													
444	STONE GREY	BIANCO BR.	stone grey	br. white																																																																																																																																																																													
451	ANTRACITE	BIANCO BR.	anthracite	br. white																																																																																																																																																																													
466	NOCE PAVIA	BIANCO BR.	pavia walnut	br. white																																																																																																																																																																													
503	ROVERE	ANTRACITE	oak	anthracite																																																																																																																																																																													
504	ROVERE GREY	ANTRACITE	grey oak	anthracite																																																																																																																																																																													
506	ARGENTO GOLF	ANTRACITE	golf silver	anthracite																																																																																																																																																																													
516	ACERO TAKI	ANTRACITE	taki maple	anthracite																																																																																																																																																																													
531	WENGE'	ANTRACITE	wenge	anthracite																																																																																																																																																																													
541	BIANCO BR.	ANTRACITE	br. white	anthracite																																																																																																																																																																													
544	STONE GREY	ANTRACITE	stone grey	anthracite																																																																																																																																																																													
566	NOCE PAVIA	ANTRACITE	pavia walnut	anthracite																																																																																																																																																																													
803	ROVERE	STONE GREY	oak	stone grey																																																																																																																																																																													
804	ROVERE GREY	STONE GREY	grey oak	stone grey																																																																																																																																																																													
805	ARGENTO GOLF	STONE GREY	golf silver	stone grey																																																																																																																																																																													
815	ACERO TAKI	STONE GREY	taki maple	stone grey																																																																																																																																																																													
830	WENGE'	STONE GREY	wenge	stone grey																																																																																																																																																																													
840	BIANCO BR.	STONE GREY	br. white	stone grey																																																																																																																																																																													
851	ANTRACITE	STONE GREY	anthracite	stone grey																																																																																																																																																																													
866	NOCE PAVIA	STONE GREY	pavia walnut	stone grey																																																																																																																																																																													
MOBILE ALTO L.45 CON 2 ANTE LEGNO CON SERRATURE high cabinet w 45 cms with 2 wooden doors with locks  	DX right	L.45	114 763 (*)	73	0,198	7	€ 295,00																																																																																																																																																																										
	SX left	L.45	114 764 (*)																																																																																																																																																																														
	L.45 x p.46,3 x H.235																																																																																																																																																																																
	MOBILE ALTO L.45 CON 1 ANTA LEGNO CON SERRATURA high cabinet w 45 cms with 1 wooden door with lock  	DX right	L.45	114 765 (*)	66	0,164	6	€ 249,00																																																																																																																																																																									
		SX left	L.45	114 766 (*)																																																																																																																																																																													
		L.45 x p.46,3 x H.235																																																																																																																																																																															



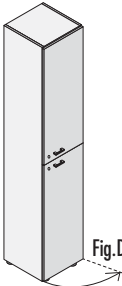
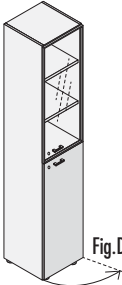
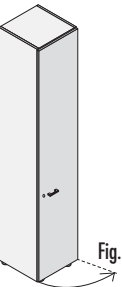

**CONTENITORI ALTI H.235** (KIT FISSAGGIO A MURO INCLUSO) **UTILIZZABILI ANCHE SENZA TOP DI FINITURA (VEDI PAG. 30)**  
*high cabinets h. 235 cms* (wall fixing kit included) *can also be used without finishing top (please see page 30)*

DESCRIZIONE <i>description</i>	L <i>w</i>	CODICE <i>code</i>	KG	M <sup>3</sup>	COLLI	PREZZO <i>price</i>	(*) CODICE FINITURA <i>(*) finish code</i>				
MOBILE ALTO L.45 CON 1 ANTA LEGNO CON SERRATURA <i>high cabinet w 45 cms with 1 wooden door with lock</i>   Fig.DX/right  L.45 x p.46,3 x H.235	DX <i>right</i>	L.45	114 <b>767</b> (*)	73	0,194	7	€ 287,00	VERSIONE MONO-COLORE / <i>single-color version</i>			
		SX <i>left</i>	L.45					114 <b>768</b> (*)	005 ARGENTO GOLF <i>golf silver</i>	166 NOCE PAVIA <i>pavia walnut</i>	
									440 BIANCO BR. <i>br. white</i>	551 ANTRACITE <i>anthracite</i>	
									844 STONE GREY <i>stone grey</i>	VERSIONE BI-COLORE / <i>double-color version</i>	
									003 ROVERE ARGENTO GOLF <i>oak golf silver</i>	004 ROVERE GREY ARGENTO GOLF <i>grey oak golf silver</i>	015 ACERO TAKI ARGENTO GOLF <i>taki maple golf silver</i>
									025 GRIGIO ARGENTO GOLF <i>grey golf silver</i>	030 WENGE' ARGENTO GOLF <i>wenge golf silver</i>	040 BIANCO BR. ARGENTO GOLF <i>br. white golf silver</i>
									044 STONE GREY ARGENTO GOLF <i>stone grey golf silver</i>	051 ANTRACITE ARGENTO GOLF <i>anthracite golf silver</i>	066 NOCE PAVIA ARGENTO GOLF <i>pavia walnut golf silver</i>
									403 ROVERE BIANCO BR. <i>oak br. white</i>	404 ROVERE GREY BIANCO BR. <i>grey oak br. white</i>	405 ARGENTO GOLF BIANCO BR. <i>golf silver br. white</i>
									415 ACERO TAKI BIANCO BR. <i>taki maple br. white</i>	430 WENGE' BIANCO BR. <i>wenge br. white</i>	444 STONE GREY BIANCO BR. <i>stone grey br. white</i>
	MOBILE ALTO L.45 CON 1 ANTA LEGNO+1 ANTA VETRO CON SERRATURE <i>high cabinet w 45 cms with 1 wooden door+1 glass door with locks</i>   Fig.DX/right  L.45 x p.46,3 x H.235	DX <i>right</i>	L.45	114 <b>769</b> (*)	75	0,197	8	€ 356,00	MOBILI FORNITI CON ANTA: <b>TELAIO ALLUMINIO E VETRO TEMPERATO SATINATO</b> <i>supplied cabinets with door: aluminium frame and tempered satined glass</i>		
SX <i>left</i>			L.45	114 <b>770</b> (*)					403 ROVERE BIANCO BR. <i>oak br. white</i>	404 ROVERE GREY BIANCO BR. <i>grey oak br. white</i>	
								405 ARGENTO GOLF BIANCO BR. <i>golf silver br. white</i>	415 ACERO TAKI BIANCO BR. <i>taki maple br. white</i>	430 WENGE' BIANCO BR. <i>wenge br. white</i>	
								444 STONE GREY BIANCO BR. <i>stone grey br. white</i>	451 ANTRACITE BIANCO BR. <i>anthracite br. white</i>	466 NOCE PAVIA BIANCO BR. <i>pavia walnut br. white</i>	
								503 ROVERE ANTRACITE <i>oak anthracite</i>	504 ROVERE GREY ANTRACITE <i>grey oak anthracite</i>	506 ARGENTO GOLF ANTRACITE <i>golf silver anthracite</i>	
								516 ACERO TAKI ANTRACITE <i>taki maple anthracite</i>	531 WENGE' ANTRACITE <i>wenge anthracite</i>	541 BIANCO BR. ANTRACITE <i>br. white anthracite</i>	
								544 STONE GREY ANTRACITE <i>stone grey anthracite</i>	566 NOCE PAVIA ANTRACITE <i>pavia walnut anthracite</i>	803 ROVERE STONE GREY <i>oak stone grey</i>	
								804 ROVERE GREY STONE GREY <i>grey oak stone grey</i>	805 ARGENTO GOLF STONE GREY <i>golf silver stone grey</i>	815 ACERO TAKI STONE GREY <i>taki maple stone grey</i>	
								830 WENGE' STONE GREY <i>wenge stone grey</i>	840 BIANCO BR. STONE GREY <i>br. white stone grey</i>	851 ANTRACITE STONE GREY <i>anthracite stone grey</i>	
								866 NOCE PAVIA STONE GREY <i>pavia walnut stone grey</i>			
MOBILE ALTO L.45 CON 1 ANTA LEGNO CON SERRATURA <i>high cabinet w 45 cms with 1 wooden door with lock</i>   Fig.DX/right  L.45 x p.46,3 x H.235	DX <i>right</i>	L.45	114 <b>771</b> (*)	76	0,196	6	€ 301,00				
	SX <i>left</i>	L.45	114 <b>772</b> (*)					815 ACERO TAKI STONE GREY <i>taki maple stone grey</i>	830 WENGE' STONE GREY <i>wenge stone grey</i>		
								840 BIANCO BR. STONE GREY <i>br. white stone grey</i>	851 ANTRACITE STONE GREY <i>anthracite stone grey</i>	866 NOCE PAVIA STONE GREY <i>pavia walnut stone grey</i>	

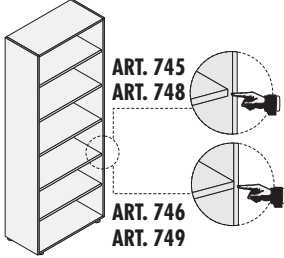
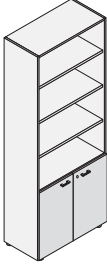

CONTENITORI UNIVERSALI EVO  
UNIVERSAL CABINETS EVO

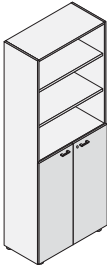

CONTENITORI ALTI H.235 high cabinets h. 235 cms		(KIT FISSAGGIO A MURO INCLUSO) (wall fixing kit included)				UTILIZZABILI ANCHE SENZA TOP DI FINITURA (VEDI PAG. 30) can also be used without finishing top (please see page 30)	
DESCRIZIONE description	L w	CODICE code	KG	M <sup>3</sup>	COLLI PCS	PREZZO price	(*) CODICE FINITURA (* finish code)
<p>MOBILE ALTO A GIORNO L.90 open high cabinet w 90 cms</p>  <p>ART. 745 ART. 748</p> <p>ART. 746 ART. 749</p>	<b>CARCASSA PER ANTE INTERE SOLO LEGNO</b> structure for whole wooden doors only						
	L.90	114 745 (*)	90	0,189	5	€ 301,00	
	<b>CARCASSA PER ANTE SPEZZATE LEGNO E TUTTE LE TIPOLOGIE DI ANTE VETRO</b> structure for split wooden doors and all types glass doors						
	L.90	114 746 (*)	90	0,189	5	€ 301,00	
	<b>CARCASSA PER ANTE INTERE SOLO LEGNO</b> structure for whole wooden doors only						
		PROF. CM 35 depth 35 cms	●= COLORI DISPONIBILI available colours				
	L.90	114 748 (*)	82	0,186	5	€ 267,00	
	<b>CARCASSA PER ANTE SPEZZATE LEGNO E TUTTE LE TIPOLOGIE DI ANTE VETRO</b> structure for split wooden doors and all types glass doors						
		PROF. CM 35 depth 35 cms	●= COLORI DISPONIBILI available colours				
	L.90	114 749 (*)	82	0,186	5	€ 267,00	
L.90 x p.44,5 x H.235							
<p>MOBILE ALTO L.90 CON 2 ANTE LEGNO CON SERRATURA high cabinet w 90 cms with 2 wooden doors with lock</p> 	VERSIONE MONO-COLORE / single-color version						
	(*)						
	005	ARGENTO GOLF	golf silver				
	166	NOCE PAVIA	pavia walnut				
	440	BIANCO BR.	br. white				
	551	ANTRACITE	anthracite				
	844	STONE GREY	stone grey				
	VERSIONE BI-COLORE / double-color version						
	(*) ANTE STRUTTURA doors structure						
	003	ROVERE	ARGENTO GOLF	oak		golf silver	
004	ROVERE GREY	ARGENTO GOLF	grey oak		golf silver		
015	ACERO TAKI	ARGENTO GOLF	taki maple		golf silver		
025	GRIGIO	ARGENTO GOLF	grey		golf silver		
030	WENGE'	ARGENTO GOLF	wenge		golf silver		
040	BIANCO BR.	ARGENTO GOLF	br. white		golf silver		
044	STONE GREY	ARGENTO GOLF	stone grey		golf silver		
051	ANTRACITE	ARGENTO GOLF	anthracite		golf silver		
066	NOCE PAVIA	ARGENTO GOLF	pavia walnut		golf silver		
403	ROVERE	BIANCO BR.	oak		br. white		
404	ROVERE GREY	BIANCO BR.	grey oak		br. white		
405	ARGENTO GOLF	BIANCO BR.	golf silver		br. white		
415	ACERO TAKI	BIANCO BR.	taki maple		br. white		
430	WENGE'	BIANCO BR.	wenge		br. white		
444	STONE GREY	BIANCO BR.	stone grey		br. white		
451	ANTRACITE	BIANCO BR.	anthracite		br. white		
466	NOCE PAVIA	BIANCO BR.	pavia walnut		br. white		
503	ROVERE	ANTRACITE	oak		anthracite		
504	ROVERE GREY	ANTRACITE	grey oak		anthracite		
506	ARGENTO GOLF	ANTRACITE	golf silver		anthracite		
516	ACERO TAKI	ANTRACITE	taki maple		anthracite		
531	WENGE'	ANTRACITE	wenge		anthracite		
541	BIANCO BR.	ANTRACITE	br. white		anthracite		
544	STONE GREY	ANTRACITE	stone grey		anthracite		
566	NOCE PAVIA	ANTRACITE	pavia walnut		anthracite		
803	ROVERE	STONE GREY	oak		stone grey		
804	ROVERE GREY	STONE GREY	grey oak		stone grey		
805	ARGENTO GOLF	STONE GREY	golf silver		stone grey		
815	ACERO TAKI	STONE GREY	taki maple		stone grey		
830	WENGE'	STONE GREY	wenge		stone grey		
840	BIANCO BR.	STONE GREY	br. white		stone grey		
851	ANTRACITE	STONE GREY	anthracite		stone grey		
866	NOCE PAVIA	STONE GREY	pavia walnut		stone grey		
L.90 x p.46,3 x H.235							
<p>MOBILE ALTO L.90 CON 4 ANTE LEGNO CON SERRATURA high cabinet w 90 cms with 4 wooden doors with locks</p> 	VERSIONE MONO-COLORE / single-color version						
	(*)						
	005	ARGENTO GOLF	golf silver				
	166	NOCE PAVIA	pavia walnut				
	440	BIANCO BR.	br. white				
	551	ANTRACITE	anthracite				
	844	STONE GREY	stone grey				
	VERSIONE BI-COLORE / double-color version						
	(*) ANTE STRUTTURA doors structure						
	003	ROVERE	ARGENTO GOLF	oak		golf silver	
004	ROVERE GREY	ARGENTO GOLF	grey oak		golf silver		
015	ACERO TAKI	ARGENTO GOLF	taki maple		golf silver		
025	GRIGIO	ARGENTO GOLF	grey		golf silver		
030	WENGE'	ARGENTO GOLF	wenge		golf silver		
040	BIANCO BR.	ARGENTO GOLF	br. white		golf silver		
044	STONE GREY	ARGENTO GOLF	stone grey		golf silver		
051	ANTRACITE	ARGENTO GOLF	anthracite		golf silver		
066	NOCE PAVIA	ARGENTO GOLF	pavia walnut		golf silver		
403	ROVERE	BIANCO BR.	oak		br. white		
404	ROVERE GREY	BIANCO BR.	grey oak		br. white		
405	ARGENTO GOLF	BIANCO BR.	golf silver		br. white		
415	ACERO TAKI	BIANCO BR.	taki maple		br. white		
430	WENGE'	BIANCO BR.	wenge		br. white		
444	STONE GREY	BIANCO BR.	stone grey		br. white		
451	ANTRACITE	BIANCO BR.	anthracite		br. white		
466	NOCE PAVIA	BIANCO BR.	pavia walnut		br. white		
503	ROVERE	ANTRACITE	oak		anthracite		
504	ROVERE GREY	ANTRACITE	grey oak		anthracite		
506	ARGENTO GOLF	ANTRACITE	golf silver		anthracite		
516	ACERO TAKI	ANTRACITE	taki maple		anthracite		
531	WENGE'	ANTRACITE	wenge		anthracite		
541	BIANCO BR.	ANTRACITE	br. white		anthracite		
544	STONE GREY	ANTRACITE	stone grey		anthracite		
566	NOCE PAVIA	ANTRACITE	pavia walnut		anthracite		
803	ROVERE	STONE GREY	oak		stone grey		
804	ROVERE GREY	STONE GREY	grey oak		stone grey		
805	ARGENTO GOLF	STONE GREY	golf silver		stone grey		
815	ACERO TAKI	STONE GREY	taki maple		stone grey		
830	WENGE'	STONE GREY	wenge		stone grey		
840	BIANCO BR.	STONE GREY	br. white		stone grey		
851	ANTRACITE	STONE GREY	anthracite		stone grey		
866	NOCE PAVIA	STONE GREY	pavia walnut		stone grey		
L.90 x p.46,3 x H.235							
<p>MOBILE ALTO L.90 CON 2 ANTE LEGNO CON SERRATURA high cabinet w 90 cms with 2 wooden doors with lock</p> 	VERSIONE MONO-COLORE / single-color version						
	(*)						
	005	ARGENTO GOLF	golf silver				
	166	NOCE PAVIA	pavia walnut				
	440	BIANCO BR.	br. white				
	551	ANTRACITE	anthracite				
	844	STONE GREY	stone grey				
	VERSIONE BI-COLORE / double-color version						
	(*) ANTE STRUTTURA doors structure						
	003	ROVERE	ARGENTO GOLF	oak		golf silver	
004	ROVERE GREY	ARGENTO GOLF	grey oak		golf silver		
015	ACERO TAKI	ARGENTO GOLF	taki maple		golf silver		
025	GRIGIO	ARGENTO GOLF	grey		golf silver		
030	WENGE'	ARGENTO GOLF	wenge		golf silver		
040	BIANCO BR.	ARGENTO GOLF	br. white		golf silver		
044	STONE GREY	ARGENTO GOLF	stone grey		golf silver		
051	ANTRACITE	ARGENTO GOLF	anthracite		golf silver		
066	NOCE PAVIA	ARGENTO GOLF	pavia walnut		golf silver		
403	ROVERE	BIANCO BR.	oak		br. white		
404	ROVERE GREY	BIANCO BR.	grey oak		br. white		
405	ARGENTO GOLF	BIANCO BR.	golf silver		br. white		
415	ACERO TAKI	BIANCO BR.	taki maple		br. white		
430	WENGE'	BIANCO BR.	wenge		br. white		
444	STONE GREY	BIANCO BR.	stone grey		br. white		
451	ANTRACITE	BIANCO BR.	anthracite		br. white		
466	NOCE PAVIA	BIANCO BR.	pavia walnut		br. white		
503	ROVERE	ANTRACITE	oak		anthracite		
504	ROVERE GREY	ANTRACITE	grey oak		anthracite		
506	ARGENTO GOLF	ANTRACITE	golf silver		anthracite		
516	ACERO TAKI	ANTRACITE	taki maple		anthracite		
531	WENGE'	ANTRACITE	wenge		anthracite		
541	BIANCO BR.	ANTRACITE	br. white		anthracite		
544	STONE GREY	ANTRACITE	stone grey		anthracite		
566	NOCE PAVIA	ANTRACITE	pavia walnut		anthracite		
803	ROVERE	STONE GREY	oak		stone grey		
804	ROVERE GREY	STONE GREY	grey oak		stone grey		
805	ARGENTO GOLF	STONE GREY	golf silver		stone grey		
815	ACERO TAKI	STONE GREY	taki maple		stone grey		
830	WENGE'	STONE GREY	wenge		stone grey		
840	BIANCO BR.	STONE GREY	br. white		stone grey		
851	ANTRACITE	STONE GREY	anthracite		stone grey		
866	NOCE PAVIA	STONE GREY	pavia walnut		stone grey		
L.90 x p.46,3 x H.235							

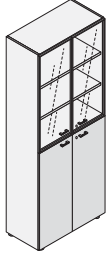

**CONTENITORI ALTI H.235** (KIT FISSAGGIO A MURO INCLUSO)  
*high cabinets h. 235 cms* (wall fixing kit included)



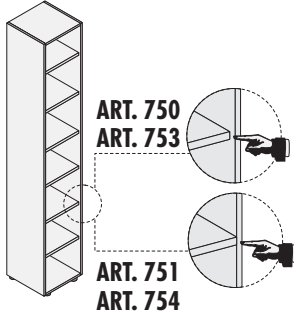
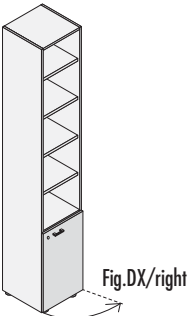
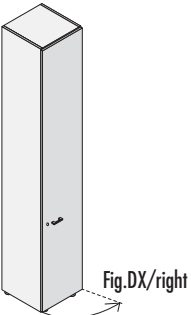

UTILIZZABILI ANCHE SENZA TOP DI FINITURA (VEDI PAG. 30)  
can also be used without finishing top (please see page 30)

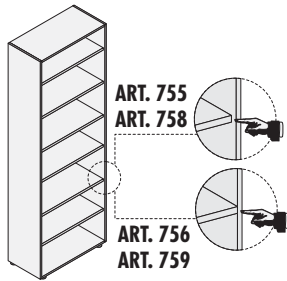
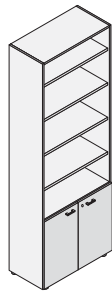
DESCRIZIONE <i>description</i>	L <i>w</i>	CODICE <i>code</i>	KG	M <sup>3</sup>	COLLI	PREZZO <i>price</i>	(*) CODICE FINITURA <i>(*) finish code</i>					
MOBILE ALTO L.90 CON 4 ANTE LEGNO CON SERRATURE <i>high cabinet w 90 cms with 4 wooden doors with locks</i>    L.90 x p.46,3 x H.235	L.90	114 777 (*)	118	0,287	7	€ 433,00	VERSIONE MONO-COLORE / <i>single-color version</i>					
							(*)	005	ARGENTO GOLF	<i>golf silver</i>		
							166	NOCE PAVIA	<i>pavia walnut</i>			
							440	BIANCO BR.	<i>br. white</i>			
							551	ANTRACITE	<i>anthracite</i>			
							844	STONE GREY	<i>stone grey</i>			
							VERSIONE BI-COLORE / <i>double-color version</i>	(*)	ANTE	STRUTTURA	doors	structure
							003	ROVERE	ARGENTO GOLF	<i>oak</i>	<i>golf silver</i>	
							004	ROVERE GREY	ARGENTO GOLF	<i>grey oak</i>	<i>golf silver</i>	
							015	ACERO TAKI	ARGENTO GOLF	<i>taki maple</i>	<i>golf silver</i>	
025	GRIGIO	ARGENTO GOLF	<i>grey</i>	<i>golf silver</i>								
030	WENGHE'	ARGENTO GOLF	<i>wenge</i>	<i>golf silver</i>								
040	BIANCO BR.	ARGENTO GOLF	<i>br. white</i>	<i>golf silver</i>								
044	STONE GREY	ARGENTO GOLF	<i>stone grey</i>	<i>golf silver</i>								
051	ANTRACITE	ARGENTO GOLF	<i>anthracite</i>	<i>golf silver</i>								
066	NOCE PAVIA	ARGENTO GOLF	<i>pavia walnut</i>	<i>golf silver</i>								
403	ROVERE	BIANCO BR.	<i>oak</i>	<i>br. white</i>								
404	ROVERE GREY	BIANCO BR.	<i>grey oak</i>	<i>br. white</i>								
405	ARGENTO GOLF	BIANCO BR.	<i>golf silver</i>	<i>br. white</i>								
415	ACERO TAKI	BIANCO BR.	<i>taki maple</i>	<i>br. white</i>								
430	WENGHE'	BIANCO BR.	<i>wenge</i>	<i>br. white</i>								
444	STONE GREY	BIANCO BR.	<i>stone grey</i>	<i>br. white</i>								
451	ANTRACITE	BIANCO BR.	<i>anthracite</i>	<i>br. white</i>								
466	NOCE PAVIA	BIANCO BR.	<i>pavia walnut</i>	<i>br. white</i>								
503	ROVERE	ANTRACITE	<i>oak</i>	<i>anthracite</i>								
504	ROVERE GREY	ANTRACITE	<i>grey oak</i>	<i>anthracite</i>								
506	ARGENTO GOLF	ANTRACITE	<i>golf silver</i>	<i>anthracite</i>								
516	ACERO TAKI	ANTRACITE	<i>taki maple</i>	<i>anthracite</i>								
531	WENGHE'	ANTRACITE	<i>wenge</i>	<i>anthracite</i>								
541	BIANCO BR.	ANTRACITE	<i>br. white</i>	<i>anthracite</i>								
544	STONE GREY	ANTRACITE	<i>stone grey</i>	<i>anthracite</i>								
566	NOCE PAVIA	ANTRACITE	<i>pavia walnut</i>	<i>anthracite</i>								
803	ROVERE	STONE GREY	<i>oak</i>	<i>stone grey</i>								
804	ROVERE GREY	STONE GREY	<i>grey oak</i>	<i>stone grey</i>								
805	ARGENTO GOLF	STONE GREY	<i>golf silver</i>	<i>stone grey</i>								
815	ACERO TAKI	STONE GREY	<i>taki maple</i>	<i>stone grey</i>								
830	WENGHE'	STONE GREY	<i>wenge</i>	<i>stone grey</i>								
840	BIANCO BR.	STONE GREY	<i>br. white</i>	<i>stone grey</i>								
851	ANTRACITE	STONE GREY	<i>anthracite</i>	<i>stone grey</i>								
866	NOCE PAVIA	STONE GREY	<i>pavia walnut</i>	<i>stone grey</i>								
MOBILE ALTO L.90 CON 2 ANTE LEGNO E 2 ANTE VETRO CON SERRATURE <i>high cabinet w 90 cms with 2 wooden doors and 2 glass doors with locks</i>    L.90 x p.46,3 x H.235	L.90	114 778 (*)	121	0,302	9	€ 577,00	MOBILE FORNITO CON ANTE: <b>TELAIO ALLUMINIO E VETRO TEMPERATO SATINATO</b> <i>supplied cabinet with doors: aluminium frame and tempered satined glass</i>					
							003	ROVERE	ARGENTO GOLF	<i>oak</i>	<i>golf silver</i>	
							004	ROVERE GREY	ARGENTO GOLF	<i>grey oak</i>	<i>golf silver</i>	
							015	ACERO TAKI	ARGENTO GOLF	<i>taki maple</i>	<i>golf silver</i>	
							025	GRIGIO	ARGENTO GOLF	<i>grey</i>	<i>golf silver</i>	
							030	WENGHE'	ARGENTO GOLF	<i>wenge</i>	<i>golf silver</i>	
							040	BIANCO BR.	ARGENTO GOLF	<i>br. white</i>	<i>golf silver</i>	
							044	STONE GREY	ARGENTO GOLF	<i>stone grey</i>	<i>golf silver</i>	
							051	ANTRACITE	ARGENTO GOLF	<i>anthracite</i>	<i>golf silver</i>	
							066	NOCE PAVIA	ARGENTO GOLF	<i>pavia walnut</i>	<i>golf silver</i>	
MOBILE ALTO L.90 CON 2 ANTE LEGNO CON SERRATURA <i>high cabinet w 90 cms with 2 wooden doors with lock</i>    L.90 x p.46,3 x H.235	L.90	114 779 (*)	125	0,275	6	€ 446,00	MOBILE FORNITO CON ANTE: <b>TELAIO ALLUMINIO E VETRO TEMPERATO SATINATO</b> <i>supplied cabinet with doors: aluminium frame and tempered satined glass</i>					
							003	ROVERE	ARGENTO GOLF	<i>oak</i>	<i>golf silver</i>	
							004	ROVERE GREY	ARGENTO GOLF	<i>grey oak</i>	<i>golf silver</i>	
							015	ACERO TAKI	ARGENTO GOLF	<i>taki maple</i>	<i>golf silver</i>	
							025	GRIGIO	ARGENTO GOLF	<i>grey</i>	<i>golf silver</i>	
							030	WENGHE'	ARGENTO GOLF	<i>wenge</i>	<i>golf silver</i>	
							040	BIANCO BR.	ARGENTO GOLF	<i>br. white</i>	<i>golf silver</i>	
							044	STONE GREY	ARGENTO GOLF	<i>stone grey</i>	<i>golf silver</i>	
							051	ANTRACITE	ARGENTO GOLF	<i>anthracite</i>	<i>golf silver</i>	
							066	NOCE PAVIA	ARGENTO GOLF	<i>pavia walnut</i>	<i>golf silver</i>	

CONTENITORI  
UNIVERSALI EVO  
UNIVERSAL CABINETS EVO

CONTENITORI ALTI H.260 high cabinets h. 260 cms		(KIT FISSAGGIO A MURO INCLUSO) (wall fixing kit included)				UTILIZZABILI ANCHE SENZA TOP DI FINITURA (VEDI PAG. 30) can also be used without finishing top (please see page 30)		
DESCRIZIONE description	L w	CODICE code	KG	M <sup>3</sup>	COLLI	PREZZO price	(*) CODICE FINITURA (* finish code)	
MOBILE ALTO A GIORNO L.45 open high cabinet w 45 cms   ART. 750 ART. 753  ART. 751 ART. 754  L.45 x p.44,5 x H.260	<b>CARCASSA PER ANTE INTERE SOLO LEGNO</b> structure for whole wooden doors only							
	L.45	114 750 (*)	72	0,147	5	€ 233,00		
	<b>CARCASSA PER ANTE SPEZZATE LEGNO E TUTTE LE TIPOLOGIE DI ANTE VETRO</b> structure for split wooden doors and all types glass doors							
	L.45	114 751 (*)	72	0,147	5	€ 233,00		
	<b>CARCASSA PER ANTE INTERE SOLO LEGNO</b> structure for whole wooden doors only							
		PROF. CM 35 depth 35 cms	●= COLORI DISPONIBILI available colours					
	L.45	114 753 (*)	67	0,137	5	€ 218,00		
	<b>CARCASSA PER ANTE SPEZZATE LEGNO E TUTTE LE TIPOLOGIE DI ANTE VETRO</b> structure for split wooden doors and all types glass doors							
		PROF. CM 35 depth 35 cms	●= COLORI DISPONIBILI available colours					
	L.45	114 754 (*)	67	0,137	5	€ 218,00		
MOBILE ALTO L.45 CON 1 ANTA BASSA LEGNO CON SERRATURA high cabinet w 45 cms with 1 low wooden door with lock   Fig.DX/right  L.45 x p.46,3 x H.260	VERSIONE MONO-COLORE / single-color version							
		(*)						
		005	ARGENTO GOLF	golf silver				
		166	NOCE PAVIA	pavia walnut				
		440	BIANCO BR.	br. white				
		551	ANTRACITE	anthracite				
		844	STONE GREY	stone grey				
	DX right	L.45	114 781 (*)	77	0,169	6	€ 264,00	
	SX left	L.45	114 782 (*)					
	VERSIONE BI-COLORE / double-color version							
	(*)	ANTE	STRUTTURA	doors	structure			
	003	ROVERE	ARGENTO GOLF	oak	golf silver			
	004	ROVERE GREY	ARGENTO GOLF	grey oak	golf silver			
	015	ACERO TAKI	ARGENTO GOLF	taki maple	golf silver			
	025	GRIGIO	ARGENTO GOLF	grey	golf silver			
	030	WENGE'	ARGENTO GOLF	wenge	golf silver			
	040	BIANCO BR.	ARGENTO GOLF	br. white	golf silver			
	044	STONE GREY	ARGENTO GOLF	stone grey	golf silver			
	051	ANTRACITE	ARGENTO GOLF	anthracite	golf silver			
	066	NOCE PAVIA	ARGENTO GOLF	pavia walnut	golf silver			
	403	ROVERE	BIANCO BR.	oak	br. white			
	404	ROVERE GREY	BIANCO BR.	grey oak	br. white			
	405	ARGENTO GOLF	BIANCO BR.	golf silver	br. white			
	415	ACERO TAKI	BIANCO BR.	taki maple	br. white			
	430	WENGE'	BIANCO BR.	wenge	br. white			
	444	STONE GREY	BIANCO BR.	stone grey	br. white			
	451	ANTRACITE	BIANCO BR.	anthracite	br. white			
	466	NOCE PAVIA	BIANCO BR.	pavia walnut	br. white			
	503	ROVERE	ANTRACITE	oak	anthracite			
	504	ROVERE GREY	ANTRACITE	grey oak	anthracite			
	506	ARGENTO GOLF	ANTRACITE	golf silver	anthracite			
	516	ACERO TAKI	ANTRACITE	taki maple	anthracite			
	531	WENGE'	ANTRACITE	wenge	anthracite			
	541	BIANCO BR.	ANTRACITE	br. white	anthracite			
	544	STONE GREY	ANTRACITE	stone grey	anthracite			
	566	NOCE PAVIA	ANTRACITE	pavia walnut	anthracite			
	803	ROVERE	STONE GREY	oak	stone grey			
	804	ROVERE GREY	STONE GREY	grey oak	stone grey			
	805	ARGENTO GOLF	STONE GREY	golf silver	stone grey			
	815	ACERO TAKI	STONE GREY	taki maple	stone grey			
	830	WENGE'	STONE GREY	wenge	stone grey			
	840	BIANCO BR.	STONE GREY	br. white	stone grey			
	851	ANTRACITE	STONE GREY	anthracite	stone grey			
	866	NOCE PAVIA	STONE GREY	pavia walnut	stone grey			
MOBILE ALTO L.45 CON 1 ANTA LEGNO CON SERRATURA high cabinet w 45 cms with 1 wooden door with lock   Fig.DX/right  L.45 x p.46,3 x H.260	DX right	L.45	114 785 (*)	92	0,242	6	€ 329,00	
	SX left	L.45	114 786 (*)					

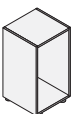
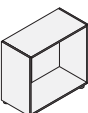
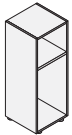
CONTENITORI ALTI H.260 high cabinets h. 260 cms		(KIT FISSAGGIO A MURO INCLUSO) (wall fixing kit included)				UTILIZZABILI ANCHE SENZA TOP DI FINITURA (VEDI PAG. 30) can also be used without finishing top (please see page 30)	
DESCRIZIONE description	L w	CODICE code	KG	M <sup>3</sup>	COLLI PCS	PREZZO price	(*) CODICE FINITURA (* finish code)
<p>MOBILE ALTO A GIORNO L.90 open high cabinet w 90 cms</p>  <p>ART. 755 ART. 758 ART. 756 ART. 759</p>	<b>CARCASSA PER ANTE INTERE SOLO LEGNO</b> structure for whole wooden doors only						
	L.90	114 755 (*)	103	0,221	5	€ 341,00	
	<b>CARCASSA PER ANTE SPEZZATE LEGNO E TUTTE LE TIPOLOGIE DI ANTE VETRO</b> structure for split wooden doors and all types glass doors						
	L.90	114 756 (*)	103	0,221	5	€ 341,00	
	<b>CARCASSA PER ANTE INTERE SOLO LEGNO</b> structure for whole wooden doors only						
		PROF. CM 35 depth 35 cms	●= COLORI DISPONIBILI available colours				
	L.90	114 758 (*)	97	0,202	5	€ 304,00	
	<b>CARCASSA PER ANTE SPEZZATE LEGNO E TUTTE LE TIPOLOGIE DI ANTE VETRO</b> structure for split wooden doors and all types glass doors						
		PROF. CM 35 depth 35 cms	●= COLORI DISPONIBILI available colours				
	L.90	114 759 (*)	97	0,202	5	€ 304,00	
L.90 x p.44,5 x H.260							
<p>MOBILE ALTO L.90 CON 2 ANTE BASSE LEGNO CON SERRATURA high cabinet w 90 cms with 2 low wooden doors with lock</p> 	VERSIONE MONO-COLORE / single-color version						
	(*)						
	005	ARGENTO GOLF	golf silver				
	166	NOCE PAVIA	pavia walnut				
	440	BIANCO BR.	br. white				
	551	ANTRACITE	anthracite				
	844	STONE GREY	stone grey				
	L.90	114 787 (*)	113	0,255	6	€ 393,00	
	VERSIONE BI-COLORE / double-color version						
	(*) ANTE STRUTTURA doors structure						
003	ROVERE	ARGENTO GOLF	oak golf silver				
004	ROVERE GREY	ARGENTO GOLF	grey oak golf silver				
015	ACERO TAKI	ARGENTO GOLF	taksi maple golf silver				
025	GRIGIO	ARGENTO GOLF	grey golf silver				
030	WENGE'	ARGENTO GOLF	wenge golf silver				
040	BIANCO BR.	ARGENTO GOLF	br. white golf silver				
044	STONE GREY	ARGENTO GOLF	stone grey golf silver				
051	ANTRACITE	ARGENTO GOLF	anthracite golf silver				
066	NOCE PAVIA	ARGENTO GOLF	pavia walnut golf silver				
403	ROVERE	BIANCO BR.	oak br. white				
404	ROVERE GREY	BIANCO BR.	grey oak br. white				
405	ARGENTO GOLF	BIANCO BR.	golf silver br. white				
415	ACERO TAKI	BIANCO BR.	taksi maple br. white				
430	WENGE'	BIANCO BR.	wenge br. white				
444	STONE GREY	BIANCO BR.	stone grey br. white				
451	ANTRACITE	BIANCO BR.	anthracite br. white				
466	NOCE PAVIA	BIANCO BR.	pavia walnut br. white				
503	ROVERE	ANTRACITE	oak anthracite				
504	ROVERE GREY	ANTRACITE	grey oak anthracite				
506	ARGENTO GOLF	ANTRACITE	golf silver anthracite				
516	ACERO TAKI	ANTRACITE	taksi maple anthracite				
531	WENGE'	ANTRACITE	wenge anthracite				
541	BIANCO BR.	ANTRACITE	br. white anthracite				
544	STONE GREY	ANTRACITE	stone grey anthracite				
566	NOCE PAVIA	ANTRACITE	pavia walnut anthracite				
803	ROVERE	STONE GREY	oak stone grey				
804	ROVERE GREY	STONE GREY	grey oak stone grey				
805	ARGENTO GOLF	STONE GREY	golf silver stone grey				
815	ACERO TAKI	STONE GREY	taksi maple stone grey				
830	WENGE'	STONE GREY	wenge stone grey				
840	BIANCO BR.	STONE GREY	br. white stone grey				
851	ANTRACITE	STONE GREY	anthracite stone grey				
866	NOCE PAVIA	STONE GREY	pavia walnut stone grey				
L.90	114 789 (*)	143	0,342	6	€ 498,00		
L.90 x p.46,3 x H.260							
<p>MOBILE ALTO L.90 CON 2 ANTE LEGNO CON SERRATURA high cabinet w 90 cms with 2 wooden doors with lock</p> 							

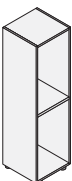
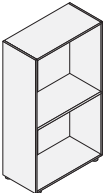
CONTENITORI SENZA RIPIANI REGISTRABILI <i>cabinets without adjustable shelves</i>							COMPLETARE CON TOP DI FINITURA (VEDI PAG. 30) complete with finishing top (please see page 30)	
DESCRIZIONE <i>description</i>	L <i>w</i>	CODICE <i>code</i>	KG 	M <sup>3</sup> 	COLLI 	PREZZO <i>price</i>	(*) CODICE FINITURA <i>(*) finish code</i>	
MOBILE BASSO A GIORNO L.45 <b>SENZA RIPIANO REGISTRABILE</b> <i>open low cabinet w 45 cms without adjustable shelf</i>		L.45	114 903 (*)	18	0,044	2	€ 70,00	
L.45 x p.44,5 x H.81,5								
MOBILE BASSO A GIORNO L.90 <b>SENZA RIPIANO REGISTRABILE</b> <i>open low cabinet w 90 cms without adjustable shelf</i>		L.90	114 904 (*)	26	0,062	2	€ 97,00	
L.90 x p.44,5 x H.81,5								
MOBILE MEDIO A GIORNO L.45 <b>SENZA RIPIANI REGISTRABILI</b> <i>open medium cabinet w 45 cms without adjustable shelves</i>		L.45	114 906 (*)	32	0,063	2	€ 96,00	
L.45 x p.44,5 x H.119,8								
MOBILE MEDIO A GIORNO L.90 <b>SENZA RIPIANI REGISTRABILI</b> <i>open medium cabinet w 90 cms without adjustable shelves</i>		L.90	114 908 (*)	44	0,089	2	€ 138,00	
L.90 x p.44,5 x H.119,8								
MOBILE MEDIO A GIORNO L.45 <b>SENZA RIPIANI REGISTRABILI</b> <i>open medium cabinet w 45 cms without adjustable shelves</i>		L.45	114 909 (*)	29	0,074	2	€ 118,00	
L.45 x p.44,5 x H.158,3								
MOBILE MEDIO A GIORNO L.90 <b>SENZA RIPIANI REGISTRABILI</b> <i>open medium cabinet w 90 cms without adjustable shelves</i>		L.90	114 911 (*)	46	0,107	2	€ 166,00	
L.90 x p.44,5 x H.158,3								

(*)	STRUTTURA	structure
005	ARGENTO GOLF	<i>golf silver</i>
166	NOCE PAVIA	<i>pavia walnut</i>
440	BIANCO BR.	<i>br. white</i>
551	ANTRACITE	<i>anthracite</i>
844	STONE GREY	<i>stone grey</i>

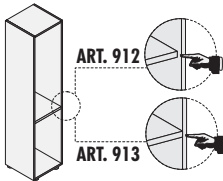
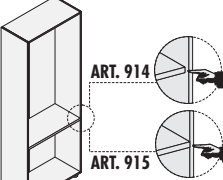
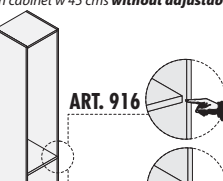
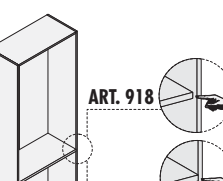
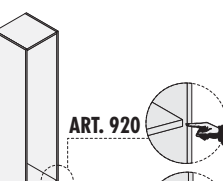
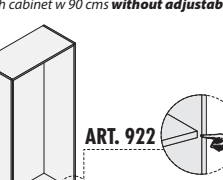
CONTENITORI SENZA RIPIANI REGISTRABILI <i>cabinets without adjustable shelves</i>		UTILIZZABILI ANCHE SENZA TOP DI FINITURA (VEDI PAG. 30) can also be used without finishing top (please see page 30)					
DESCRIZIONE <i>description</i>	L <i>w</i>	CODICE <i>code</i>	KG	M <sup>3</sup>	COLLI	PREZZO <i>price</i>	(*) CODICE FINITURA <i>(*) finish code</i>
MOBILE ALTO A GIORNO L.45 <b>SENZA RIPIANI REGISTRABILI</b> <i>open high cabinet w 45 cms without adjustable shelves</i>  ART. 912 ART. 913 L.45 x p.44,5 x H.196,7	<b>CARCASSA PER ANTE INTERE SOLO LEGNO</b> <i>structure for whole wooden doors only</i>						
	L.45	114 912 (*)	39	0,085	2	€ 138,00	
	<b>CARCASSA PER ANTE SPEZZATE LEGNO E TUTTE LE TIPOLOGIE DI ANTE VETRO</b> <i>structure for split wooden doors and all types glass doors</i>						
	L.45	114 913 (*)	39	0,085	2	€ 138,00	
MOBILE ALTO A GIORNO L.90 <b>SENZA RIPIANI REGISTRABILI</b> <i>open high cabinet w 90 cms without adjustable shelves</i>  ART. 914 ART. 915 L.90 x p.44,5 x H.196,7	<b>CARCASSA PER ANTE INTERE SOLO LEGNO</b> <i>structure for whole wooden doors only</i>						
	L.90	114 914 (*)	57	0,126	3	€ 189,00	
	<b>CARCASSA PER ANTE SPEZZATE LEGNO E TUTTE LE TIPOLOGIE DI ANTE VETRO</b> <i>structure for split wooden doors and all types glass doors</i>						
	L.90	114 915 (*)	57	0,126	3	€ 189,00	
MOBILE ALTO A GIORNO L.45 <b>SENZA RIPIANI REGISTRABILI</b> <i>open high cabinet w 45 cms without adjustable shelves</i>  ART. 916 ART. 917 L.45 x p.44,5 x H.235	<b>(KIT FISSAGGIO A MURO INCLUSO)</b> <i>(wall fixing kit included)</i>						
	<b>CARCASSA PER ANTE INTERE SOLO LEGNO</b> <i>structure for whole wooden doors only</i>						
	L.45	114 916 (*)	45	0,103	3	€ 169,00	
	<b>CARCASSA PER ANTE SPEZZATE LEGNO E TUTTE LE TIPOLOGIE DI ANTE VETRO</b> <i>structure for split wooden doors and all types glass doors</i>						
L.45	114 917 (*)	45	0,103	3	€ 169,00		
MOBILE ALTO A GIORNO L.90 <b>SENZA RIPIANI REGISTRABILI</b> <i>open high cabinet w 90 cms without adjustable shelves</i>  ART. 918 ART. 919 L.90 x p.44,5 x H.235	<b>(KIT FISSAGGIO A MURO INCLUSO)</b> <i>(wall fixing kit included)</i>						
	<b>CARCASSA PER ANTE INTERE SOLO LEGNO</b> <i>structure for whole wooden doors only</i>						
	L.90	114 918 (*)	65	0,145	4	€ 226,00	
	<b>CARCASSA PER ANTE SPEZZATE LEGNO E TUTTE LE TIPOLOGIE DI ANTE VETRO</b> <i>structure for split wooden doors and all types glass doors</i>						
L.90	114 919 (*)	65	0,145	4	€ 226,00		
MOBILE ALTO A GIORNO L.45 <b>SENZA RIPIANI REGISTRABILI</b> <i>open high cabinet w 45 cms without adjustable shelves</i>  ART. 920 ART. 921 L.45 x p.44,5 x H.260	<b>(KIT FISSAGGIO A MURO INCLUSO)</b> <i>(wall fixing kit included)</i>						
	<b>CARCASSA PER ANTE INTERE SOLO LEGNO</b> <i>structure for whole wooden doors only</i>						
	L.45	114 920 (*)	54	0,112	3	€ 185,00	
	<b>CARCASSA PER ANTE SPEZZATE LEGNO E TUTTE LE TIPOLOGIE DI ANTE VETRO</b> <i>structure for split wooden doors and all types glass doors</i>						
L.45	114 921 (*)	54	0,112	3	€ 185,00		
MOBILE ALTO A GIORNO L.90 <b>SENZA RIPIANI REGISTRABILI</b> <i>open high cabinet w 90 cms without adjustable shelves</i>  ART. 922 ART. 923 L.90 x p.44,5 x H.260	<b>(KIT FISSAGGIO A MURO INCLUSO)</b> <i>(wall fixing kit included)</i>						
	<b>CARCASSA PER ANTE INTERE SOLO LEGNO</b> <i>structure for whole wooden doors only</i>						
	L.90	114 922 (*)	75	0,156	4	€ 249,00	
	<b>CARCASSA PER ANTE SPEZZATE LEGNO E TUTTE LE TIPOLOGIE DI ANTE VETRO</b> <i>structure for split wooden doors and all types glass doors</i>						
L.90	114 923 (*)	75	0,156	4	€ 249,00		

(*)	STRUTTURA	structure
005	ARGENTO GOLF	<i>golf silver</i>
166	NOCE PAVIA	<i>pavia walnut</i>
440	BIANCO BR.	<i>br. white</i>
551	ANTRACITE	<i>anthracite</i>
844	STONE GREY	<i>stone grey</i>

CONTENITORI UNIVERSALI EVO  
universal cabinets EVO

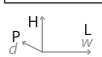

**TOP DI FINITURA**

finish top

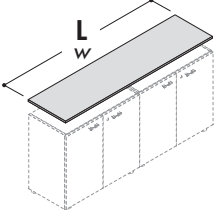
DESCRIZIONE description	L w	CODICE code	KG	M <sup>3</sup>	COLLI	PREZZO price	(*) CODICE FINITURA (* finish code)	
TOPS PER MOBILI tops for cabinets  	<b>PROF. CM 46,9</b> depth 46,9 cms							
	L.45	114 <b>660</b> (*)	4	0,009	1	€ 14,00		
	L.90	114 <b>662</b> (*)	6	0,021	1	€ 22,00		
	L.135,2	114 <b>663</b> (*)	8	0,025	1	€ 32,00		
	L.180,2	114 <b>664</b> (*)	11	0,035	1	€ 42,00		
	L.225,1	114 <b>665</b> (*)	14	0,046	1	€ 49,00		
	L.270,1	114 <b>666</b> (*)	16	0,052	1	€ 58,00		
	<b>PROF. CM 37</b> depth 37 cms							
	L.45	114 <b>670</b> (*)	3	0,009	1	€ 12,00		
	L.90	114 <b>672</b> (*)	5	0,014	1	€ 19,00		
	L.135,2	114 <b>673</b> (*)	7	0,023	1	€ 26,00		
	L.180,2	114 <b>674</b> (*)	9	0,028	1	€ 34,00		
	L.225,1	114 <b>675</b> (*)	12	0,035	1	€ 43,00		
	L.270,1	114 <b>676</b> (*)	14	0,042	1	€ 50,00		
								(*)
								005 ARGENTO GOLF golf silver
								155 ACERO TAKI taki maple
								166 NOCE PAVIA pavia walnut
								300 GRIGIO grey
								305 WENGE' wenge
								440 BIANCO BR. br. white
								551 ANTRACITE anthracite
								704 ROVERE GREY grey oak
							733 ROVERE oak	
							844 STONE GREY stone grey	

L x p.46,9 x H.1,8

**STRUTTURA METALLICA PER CONTENITORI BASSI, MEDI E ALTI**

metallic structure for low, medium and high cabinets

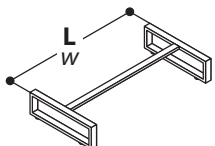
DESCRIZIONE description	L w	CODICE code	KG	M <sup>3</sup>	COLLI	PREZZO price	(*) CODICE FINITURA (* finish code)
STRUTTURA METALLICA PER CONTENITORI FREE-STANDING metallic structure for free-standing cabinets  	L.45	114 <b>796</b> (*)	5	0,037	1	€ 61,00	
	L.90	114 <b>797</b> (*)	9	0,069	1	€ 76,00	
							000 ARGENTO silver
							440 BIANCO BR. br. white
							551 ANTRACITE anthracite
							844 STONE GREY stone grey

L x p.45,5 x H.14

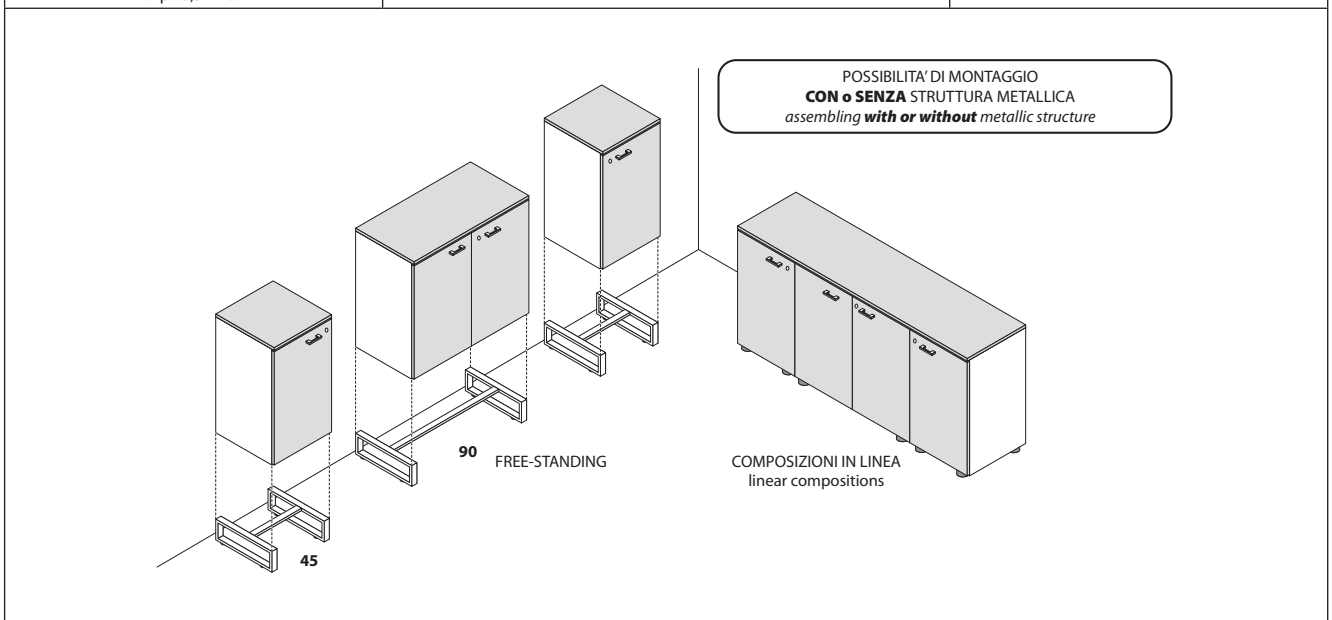



**RIPIANI E CASSETTI CLASSIFICATORI PER CONTENITORI**

*adjustable shelves and file-drawers for cabinets*

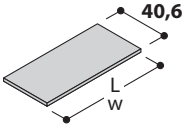
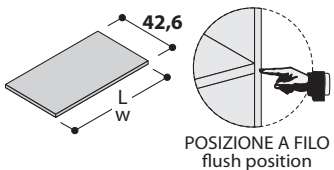
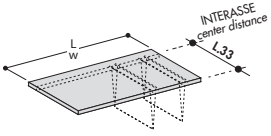
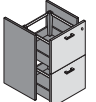
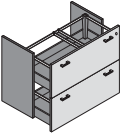
DESCRIZIONE <i>description</i>	L <i>w</i>	CODICE <i>code</i>	KG	M <sup>3</sup>	COLLI	PREZZO <i>price</i>	(*) CODICE FINITURA <i>(*) finish code</i>																																												
1 RIPIANO REGISTRABILE SUPPLEMENTARE 1 adjustable additional shelf 	L41,2	114 207 (*)	3	0,009	1	€ 14,00	<table border="1"> <thead> <tr> <th>(*)</th> <th>STRUTTURA</th> <th>structure</th> </tr> </thead> <tbody> <tr><td>005</td><td>ARGENTO GOLF</td><td>golf silver</td></tr> <tr><td>166</td><td>NOCE PAVIA</td><td>pavia walnut</td></tr> <tr><td>440</td><td>BIANCO BR.</td><td>br. white</td></tr> <tr><td>551</td><td>ANTRACITE</td><td>anthracite</td></tr> <tr><td>844</td><td>STONE GREY</td><td>stone grey</td></tr> </tbody> </table>	(*)	STRUTTURA	structure	005	ARGENTO GOLF	golf silver	166	NOCE PAVIA	pavia walnut	440	BIANCO BR.	br. white	551	ANTRACITE	anthracite	844	STONE GREY	stone grey																										
	(*)	STRUTTURA	structure																																																
	005	ARGENTO GOLF	golf silver																																																
	166	NOCE PAVIA	pavia walnut																																																
	440	BIANCO BR.	br. white																																																
551	ANTRACITE	anthracite																																																	
844	STONE GREY	stone grey																																																	
L86,2	114 208 (*)	6	0,018	1	€ 22,00																																														
		PROF. CM 31 depth 12 1/4"	● = COLORI DISPONIBILI available colours																																																
L41,2	114 209 (*)	3	0,009	1	€ 12,00																																														
L86,2	114 210 (*)	5	0,018	1	€ 18,00																																														
1 RIPIANO FISSO SUPPLEMENTARE 1 additional fixed shelf 	L41,2	114 587 (*)	3	0,009	1	€ 14,00	<table border="1"> <thead> <tr> <th>(*)</th> <th>STRUTTURA</th> <th>structure</th> </tr> </thead> <tbody> <tr><td>005</td><td>ARGENTO GOLF</td><td>golf silver</td></tr> <tr><td>166</td><td>NOCE PAVIA</td><td>pavia walnut</td></tr> <tr><td>440</td><td>BIANCO BR.</td><td>br. white</td></tr> <tr><td>551</td><td>ANTRACITE</td><td>anthracite</td></tr> <tr><td>844</td><td>STONE GREY</td><td>stone grey</td></tr> </tbody> </table>	(*)	STRUTTURA	structure	005	ARGENTO GOLF	golf silver	166	NOCE PAVIA	pavia walnut	440	BIANCO BR.	br. white	551	ANTRACITE	anthracite	844	STONE GREY	stone grey																										
	(*)	STRUTTURA	structure																																																
	005	ARGENTO GOLF	golf silver																																																
	166	NOCE PAVIA	pavia walnut																																																
	440	BIANCO BR.	br. white																																																
551	ANTRACITE	anthracite																																																	
844	STONE GREY	stone grey																																																	
L86,2	114 588 (*)	6	0,019	1	€ 22,00																																														
		PROF. CM 33 depth 33 cms	● = COLORI DISPONIBILI available colours																																																
L41,2	114 589 (*)	3	0,006	1	€ 12,00																																														
L86,2	114 590 (*)	5	0,016	1	€ 18,00																																														
1 RIPIANO IN METALLO 1 metal shelf 	L41,2	175 132 (*)	2	0,009	1	€ 35,00	<table border="1"> <thead> <tr> <th>(*)</th> <th>STRUTTURA</th> <th>structure</th> </tr> </thead> <tbody> <tr><td>000</td><td>ARGENTO</td><td>silver</td></tr> <tr><td>450</td><td>BIANCO BR.</td><td>br. white</td></tr> <tr><td>551</td><td>ANTRACITE</td><td>anthracite</td></tr> <tr><td>844</td><td>STONE GREY</td><td>stone grey</td></tr> </tbody> </table>	(*)	STRUTTURA	structure	000	ARGENTO	silver	450	BIANCO BR.	br. white	551	ANTRACITE	anthracite	844	STONE GREY	stone grey																													
	(*)	STRUTTURA	structure																																																
	000	ARGENTO	silver																																																
	450	BIANCO BR.	br. white																																																
551	ANTRACITE	anthracite																																																	
844	STONE GREY	stone grey																																																	
L86,2	175 131 (*)	4	0,018	1	€ 46,00																																														
2 CASSETTI CLASSIFICATORI PER MOBILE L.45 set of 2 file-drawers for cabinet w 45 cms 			CON SERRATURA with lock		€ 172,00	<table border="1"> <thead> <tr> <th>(*)</th> <th>FRONTALI</th> <th>fronts</th> </tr> </thead> <tbody> <tr><td>005</td><td>ARGENTO GOLF</td><td>golf silver</td></tr> <tr><td>155</td><td>ACERO TAKI</td><td>taki maple</td></tr> <tr><td>166</td><td>NOCE PAVIA</td><td>pavia walnut</td></tr> <tr><td>300</td><td>GRIGIO</td><td>grey</td></tr> <tr><td>305</td><td>WENGE'</td><td>wenge</td></tr> <tr><td>440</td><td>BIANCO BR.</td><td>br. white</td></tr> <tr><td>551</td><td>ANTRACITE</td><td>anthracite</td></tr> <tr><td>611</td><td>GIALLO FRESIA</td><td>freesia yellow</td></tr> <tr><td>632</td><td>AZZURRO SKY</td><td>sky blue</td></tr> <tr><td>633</td><td>AMARANTO</td><td>amaranth</td></tr> <tr><td>696</td><td>VERDE BOSCO</td><td>wood green</td></tr> <tr><td>704</td><td>ROVERE GREY</td><td>grey oak</td></tr> <tr><td>733</td><td>ROVERE</td><td>oak</td></tr> <tr><td>844</td><td>STONE GREY</td><td>stone grey</td></tr> </tbody> </table>	(*)	FRONTALI	fronts	005	ARGENTO GOLF	golf silver	155	ACERO TAKI	taki maple	166	NOCE PAVIA	pavia walnut	300	GRIGIO	grey	305	WENGE'	wenge	440	BIANCO BR.	br. white	551	ANTRACITE	anthracite	611	GIALLO FRESIA	freesia yellow	632	AZZURRO SKY	sky blue	633	AMARANTO	amaranth	696	VERDE BOSCO	wood green	704	ROVERE GREY	grey oak	733	ROVERE	oak	844	STONE GREY	stone grey
	(*)	FRONTALI	fronts																																																
005	ARGENTO GOLF	golf silver																																																	
155	ACERO TAKI	taki maple																																																	
166	NOCE PAVIA	pavia walnut																																																	
300	GRIGIO	grey																																																	
305	WENGE'	wenge																																																	
440	BIANCO BR.	br. white																																																	
551	ANTRACITE	anthracite																																																	
611	GIALLO FRESIA	freesia yellow																																																	
632	AZZURRO SKY	sky blue																																																	
633	AMARANTO	amaranth																																																	
696	VERDE BOSCO	wood green																																																	
704	ROVERE GREY	grey oak																																																	
733	ROVERE	oak																																																	
844	STONE GREY	stone grey																																																	
		114 638 (*)	16	0,167	1																																														
2 CASSETTI CLASSIFICATORI PER MOBILE L.90 set of 2 file-drawers for cabinet w 90 cms 			CON SERRATURA with lock		€ 216,00	<table border="1"> <thead> <tr> <th>(*)</th> <th>FRONTALI</th> <th>fronts</th> </tr> </thead> <tbody> <tr><td>005</td><td>ARGENTO GOLF</td><td>golf silver</td></tr> <tr><td>155</td><td>ACERO TAKI</td><td>taki maple</td></tr> <tr><td>166</td><td>NOCE PAVIA</td><td>pavia walnut</td></tr> <tr><td>300</td><td>GRIGIO</td><td>grey</td></tr> <tr><td>305</td><td>WENGE'</td><td>wenge</td></tr> <tr><td>440</td><td>BIANCO BR.</td><td>br. white</td></tr> <tr><td>551</td><td>ANTRACITE</td><td>anthracite</td></tr> <tr><td>611</td><td>GIALLO FRESIA</td><td>freesia yellow</td></tr> <tr><td>632</td><td>AZZURRO SKY</td><td>sky blue</td></tr> <tr><td>633</td><td>AMARANTO</td><td>amaranth</td></tr> <tr><td>696</td><td>VERDE BOSCO</td><td>wood green</td></tr> <tr><td>704</td><td>ROVERE GREY</td><td>grey oak</td></tr> <tr><td>733</td><td>ROVERE</td><td>oak</td></tr> <tr><td>844</td><td>STONE GREY</td><td>stone grey</td></tr> </tbody> </table>	(*)	FRONTALI	fronts	005	ARGENTO GOLF	golf silver	155	ACERO TAKI	taki maple	166	NOCE PAVIA	pavia walnut	300	GRIGIO	grey	305	WENGE'	wenge	440	BIANCO BR.	br. white	551	ANTRACITE	anthracite	611	GIALLO FRESIA	freesia yellow	632	AZZURRO SKY	sky blue	633	AMARANTO	amaranth	696	VERDE BOSCO	wood green	704	ROVERE GREY	grey oak	733	ROVERE	oak	844	STONE GREY	stone grey
	(*)	FRONTALI	fronts																																																
005	ARGENTO GOLF	golf silver																																																	
155	ACERO TAKI	taki maple																																																	
166	NOCE PAVIA	pavia walnut																																																	
300	GRIGIO	grey																																																	
305	WENGE'	wenge																																																	
440	BIANCO BR.	br. white																																																	
551	ANTRACITE	anthracite																																																	
611	GIALLO FRESIA	freesia yellow																																																	
632	AZZURRO SKY	sky blue																																																	
633	AMARANTO	amaranth																																																	
696	VERDE BOSCO	wood green																																																	
704	ROVERE GREY	grey oak																																																	
733	ROVERE	oak																																																	
844	STONE GREY	stone grey																																																	
		114 639 (*)	22	0,328	1																																														

**SCHEMA DI UTILIZZO CARTELLE SU CLASSIFICATORI**

*scheme for using folders in file-cabinets*

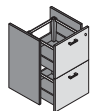

**ART.638**

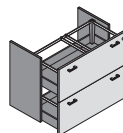

**ART.639**

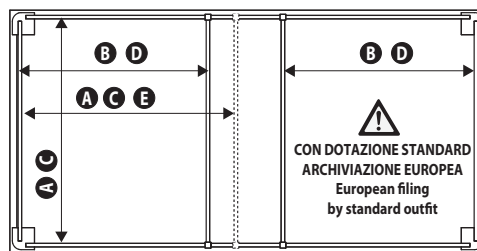

POS.	TIPO DI CARTELLA <i>type of folder</i>	INTERASSE center distance (cm)
A	GRANDE EUROPA <i>big Europe</i>	cm 39
B	PICCOLA EUROPA <i>little Europe</i>	cm 33
C	GRANDE U.S.A. <i>big U.S.A.</i>	cm 38,5
D	PICCOLA U.S.A. <i>little U.S.A.</i>	cm 31
E	GRANDE CILE <i>big Chile</i>	cm 37,2

= CON DOTAZIONE STANDARD ARCHIVIAZIONE EUROPEA  
= European filing by standard outfit

**COMPLEMENTI PER CONTENITORI**  
*complements for cabinets*

DESCRIZIONE <i>description</i>	L <i>w</i>	CODICE <i>code</i>	KG	M <sup>3</sup>	COLLI	PREZZO <i>price</i>	(*) CODICE FINITURA <i>(*) finish code</i>
1 ANTA BASSA DX O SX SENZA SERRATURA (REVERSIBILE) 1 low wooden door without lock (reversible)		SENZA SERRATURA without lock	4,5	0,009	1	€ 18,00	(*) ANTA <i>door</i>
							114 586 (*)
ESEMPI DI UTILIZZO: examples of use:							155 ACERO TAKI <i>taki maple</i>
							166 NOCE PAVIA <i>pavia walnut</i>
							300 GRIGIO <i>grey</i>
							305 WENGE' <i>wenge</i>
							440 BIANCO BR. <i>br. white</i>
							551 ANTRACITE <i>anthracite</i>
							611 GIALLO FRESIA <i>freesia yellow</i>
							632 AZZURRO SKY <i>sky blue</i>
							633 AMARANTO <i>amaranth</i>
							696 VERDE BOSCO <i>wood green</i>
							704 ROVERE GREY <i>grey oak</i>
							733 ROVERE <i>oak</i>
844 STONE GREY <i>stone grey</i>							

ABACO PER UTILIZZO A SCHEMA LIBERO  
DI ANTE BASSE SU LIBRERIE A GIORNO  
*abacus of open pattern use of low wooden doors on open bookcases*

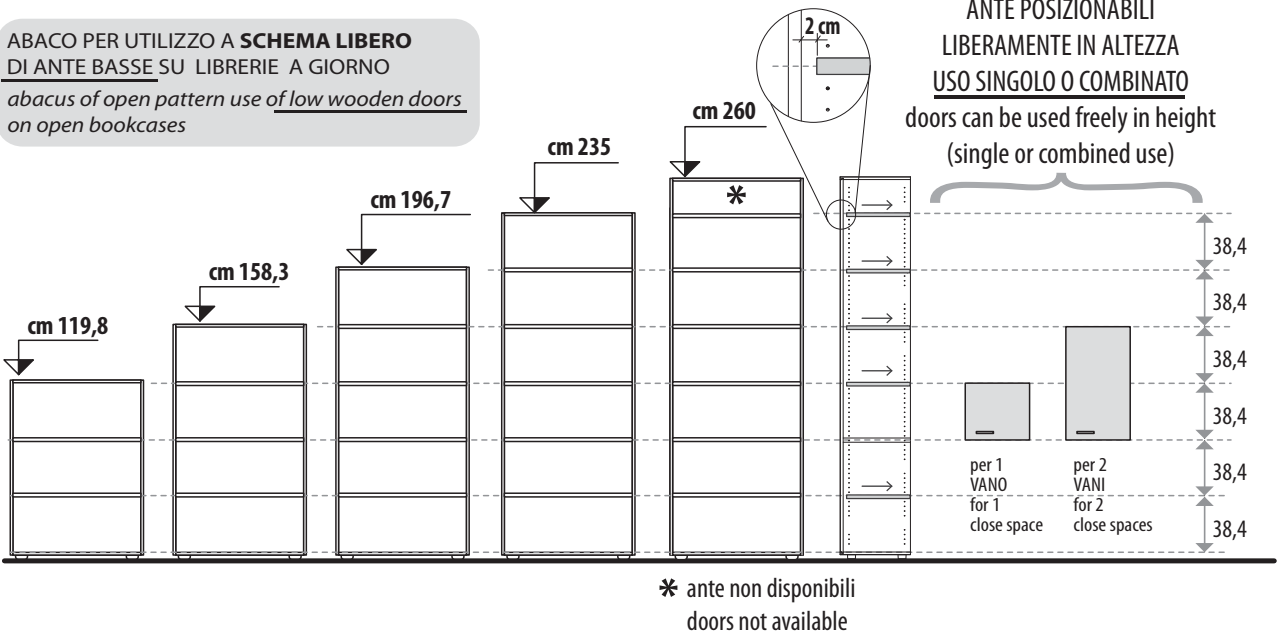

VANI DA CHIUDERE IN ALTEZZA <i>enclosed spaces in height</i>	ARTICOLI ANTE DA UTILIZZARE: <i>USE DOORS:</i>	
	L.45 SENZA SERRATURA <i>w 45 cms without lock</i>	L.90 SENZA SERRATURA <i>w 90 cms without lock</i>
1	N°1 ART.586	N°2 ART.586
2	ART. 552	ART. 555

**ESEMPI**  
*examples*

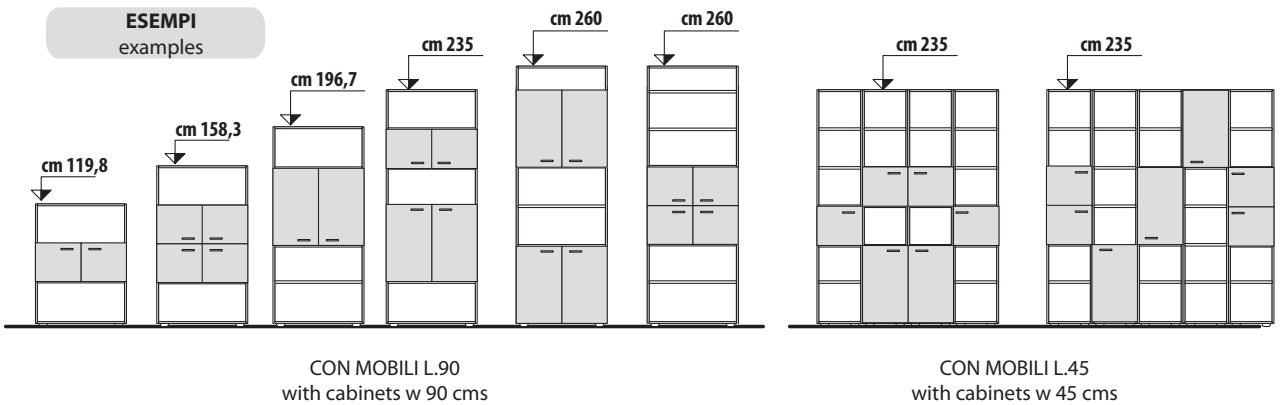

COMPLEMENTI PER CONTENITORI complements for cabinets																																																				
DESCRIZIONE description	L w	CODICE code	KG	M <sup>3</sup>	COLLI	PREZZO price	(*) CODICE FINITURA (* finish code)																																													
<p>ANTA BASSA DX CON SERRATURA (REVERSIBILE SX PER SOVRAPPOSIZIONE) low right wooden door with lock (left reversible for superimposition)</p>		<b>CON SERRATURA with lock</b>																																																		
	DX right		<b>114 550 (*)</b>	5	0,022	1	<b>€ 31,00</b>																																													
<p>ANTA BASSA SX CON SERRATURA (REVERSIBILE DX PER SOVRAPPOSIZIONE) low left wooden door with lock (right reversible for superimposition)</p>		<b>CON SERRATURA with lock</b>																																																		
	SX left		<b>114 551 (*)</b>	5	0,022	1	<b>€ 31,00</b>																																													
<p>ANTA BASSA DX O SX SENZA SERRATURA (REVERSIBILE PER SOVRAPPOSIZIONE) low right or left wooden door without lock (reversible for superimposition)</p>		<b>SENZA SERRATURA without lock</b>																																																		
			<b>114 552 (*)</b>	5	0,022	1	<b>€ 25,00</b>																																													
<p>COPPIA ANTE BASSE CON SERRATURA set of 2 low wooden doors with lock</p>		<b>CON SERRATURA with lock</b>																																																		
			<b>114 554 (*)</b>	10	0,033	1	<b>€ 52,00</b>																																													
<p>COPPIA ANTE BASSE SENZA SERRATURA (REVERSIBILE PER SOVRAPPOSIZIONE) set of 2 low wooden doors without lock (reversible for superimposition)</p>		<b>SENZA SERRATURA without lock</b>																																																		
			<b>114 555 (*)</b>	10	0,033	1	<b>€ 46,00</b>																																													
							<table border="1"> <thead> <tr> <th>(*)</th> <th>ANTE</th> <th>doors</th> </tr> </thead> <tbody> <tr><td>005</td><td>ARGENTO GOLF</td><td>golf silver</td></tr> <tr><td>155</td><td>ACERO TAKI</td><td>taki maple</td></tr> <tr><td>166</td><td>NOCE PAVIA</td><td>pavia walnut</td></tr> <tr><td>300</td><td>GRIGIO</td><td>grey</td></tr> <tr><td>305</td><td>WENGE'</td><td>wenge</td></tr> <tr><td>440</td><td>BIANCO BR.</td><td>br. white</td></tr> <tr><td>551</td><td>ANTRACITE</td><td>anthracite</td></tr> <tr><td>611</td><td>GIALLO FRESIA</td><td>freesia yellow</td></tr> <tr><td>632</td><td>AZZURRO SKY</td><td>sky blue</td></tr> <tr><td>633</td><td>AMARANTO</td><td>amaranth</td></tr> <tr><td>696</td><td>VERDE BOSCO</td><td>wood green</td></tr> <tr><td>704</td><td>ROVERE GREY</td><td>grey oak</td></tr> <tr><td>733</td><td>ROVERE</td><td>oak</td></tr> <tr><td>844</td><td>STONE GREY</td><td>stone grey</td></tr> </tbody> </table>	(*)	ANTE	doors	005	ARGENTO GOLF	golf silver	155	ACERO TAKI	taki maple	166	NOCE PAVIA	pavia walnut	300	GRIGIO	grey	305	WENGE'	wenge	440	BIANCO BR.	br. white	551	ANTRACITE	anthracite	611	GIALLO FRESIA	freesia yellow	632	AZZURRO SKY	sky blue	633	AMARANTO	amaranth	696	VERDE BOSCO	wood green	704	ROVERE GREY	grey oak	733	ROVERE	oak	844	STONE GREY	stone grey
(*)	ANTE	doors																																																		
005	ARGENTO GOLF	golf silver																																																		
155	ACERO TAKI	taki maple																																																		
166	NOCE PAVIA	pavia walnut																																																		
300	GRIGIO	grey																																																		
305	WENGE'	wenge																																																		
440	BIANCO BR.	br. white																																																		
551	ANTRACITE	anthracite																																																		
611	GIALLO FRESIA	freesia yellow																																																		
632	AZZURRO SKY	sky blue																																																		
633	AMARANTO	amaranth																																																		
696	VERDE BOSCO	wood green																																																		
704	ROVERE GREY	grey oak																																																		
733	ROVERE	oak																																																		
844	STONE GREY	stone grey																																																		

CONTENITORI UNIVERSALI EVO  
universal cabinets EVO

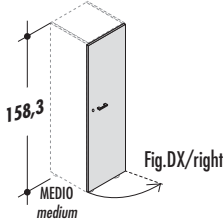
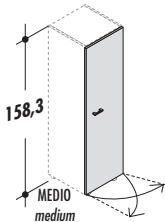
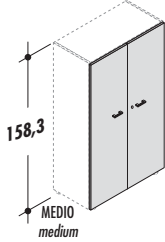
COMPLEMENTI PER CONTENITORI H.158,3 complements for cabinets h. 158,3 cms																																																				
DESCRIZIONE description	L w	CODICE code	KG	M <sup>3</sup>	COLLI	PREZZO price	(*) CODICE FINITURA (*) finish code																																													
ANTA MEDIA CON SERRATURA medium wooden door with lock  	<b>CON SERRATURA with lock</b>		10	0,042	1	€ 53,00																																														
	DX right	114 <b>562</b> (*)																																																		
	SX left	114 <b>563</b> (*)																																																		
<table border="1"> <thead> <tr> <th>(*)</th> <th>ANTE</th> <th>doors</th> </tr> </thead> <tbody> <tr><td>005</td><td>ARGENTO GOLF</td><td>golf silver</td></tr> <tr><td>155</td><td>ACERO TAKI</td><td>taki maple</td></tr> <tr><td>166</td><td>NOCE PAVIA</td><td>pavia walnut</td></tr> <tr><td>300</td><td>GRIGIO</td><td>grey</td></tr> <tr><td>305</td><td>WENGE'</td><td>wenge</td></tr> <tr><td>440</td><td>BIANCO BR.</td><td>br. white</td></tr> <tr><td>551</td><td>ANTRACITE</td><td>anthracite</td></tr> <tr><td>611</td><td>GIALLO FRESIA</td><td>freesia yellow</td></tr> <tr><td>632</td><td>AZZURRO SKY</td><td>sky blue</td></tr> <tr><td>633</td><td>AMARANTO</td><td>amaranth</td></tr> <tr><td>696</td><td>VERDE BOSCO</td><td>wood green</td></tr> <tr><td>704</td><td>ROVERE GREY</td><td>grey oak</td></tr> <tr><td>733</td><td>ROVERE</td><td>oak</td></tr> <tr><td>844</td><td>STONE GREY</td><td>stone grey</td></tr> </tbody> </table>								(*)	ANTE	doors	005	ARGENTO GOLF	golf silver	155	ACERO TAKI	taki maple	166	NOCE PAVIA	pavia walnut	300	GRIGIO	grey	305	WENGE'	wenge	440	BIANCO BR.	br. white	551	ANTRACITE	anthracite	611	GIALLO FRESIA	freesia yellow	632	AZZURRO SKY	sky blue	633	AMARANTO	amaranth	696	VERDE BOSCO	wood green	704	ROVERE GREY	grey oak	733	ROVERE	oak	844	STONE GREY	stone grey
(*)	ANTE	doors																																																		
005	ARGENTO GOLF	golf silver																																																		
155	ACERO TAKI	taki maple																																																		
166	NOCE PAVIA	pavia walnut																																																		
300	GRIGIO	grey																																																		
305	WENGE'	wenge																																																		
440	BIANCO BR.	br. white																																																		
551	ANTRACITE	anthracite																																																		
611	GIALLO FRESIA	freesia yellow																																																		
632	AZZURRO SKY	sky blue																																																		
633	AMARANTO	amaranth																																																		
696	VERDE BOSCO	wood green																																																		
704	ROVERE GREY	grey oak																																																		
733	ROVERE	oak																																																		
844	STONE GREY	stone grey																																																		
ANTA MEDIA DX O SX SENZA SERRATURA right or left medium wooden door without lock  	<b>SENZA SERRATURA without lock</b>		10	0,042	1	€ 47,00																																														
		114 <b>564</b> (*)																																																		
COPPIA ANTE MEDIE set of 2 medium wooden doors  	<b>CON SERRATURA with lock</b>		20	0,064	1	€ 85,00																																														
		114 <b>566</b> (*)																																																		
		<b>SENZA SERRATURA without lock</b>		20	0,064	1	€ 79,00																																													
	114 <b>567</b> (*)																																																			

**COMPLEMENTI PER CONTENITORI H.119,8-H.196,7-H.235**  
*complements for cabinets h. 119,8-196,7-235 cms*

DESCRIZIONE <i>description</i>	L <i>w</i>	CODICE <i>code</i>	KG	M <sup>3</sup>	COLLI	PREZZO <i>price</i>	(*) CODICE FINITURA <i>(*) finish code</i>
<p>ANTA MEDIA SUPERIORE DX CON SERRATURA (REVERSIBILE SX IN POSIZIONE BASSA) <i>right medium wooden door with lock (left reversible for lower place)</i></p> <p><b>Fig.DX/right</b></p>		<b>CON SERRATURA with lock</b>					
	<b>DX right</b>	<b>114 556 (*)</b>	7	0,030	1	<b>€ 38,00</b>	
<p>ANTA MEDIA SUPERIORE SX CON SERRATURA (REVERSIBILE DX IN POSIZIONE BASSA) <i>left medium wooden door with lock (right reversible for lower place)</i></p> <p><b>Fig.SX/left</b></p>		<b>CON SERRATURA with lock</b>					
	<b>SX left</b>	<b>114 557 (*)</b>	7	0,030	1	<b>€ 38,00</b>	
<p>ANTA MEDIA SUPERIORE DX O SX SENZA SERRATURA (REVERSIBILE IN POSIZIONE BASSA) <i>upper medium right or left wooden door without lock (reversible in lower place)</i></p>		<b>SENZA SERRATURA without lock</b>					
		<b>114 558 (*)</b>	7	0,030	1	<b>€ 31,00</b>	
<p>COPPIA ANTE MEDIE SUPERIORI CON SERRATURA <i>set of 2 upper medium wooden door with lock</i></p>		<b>CON SERRATURA with lock</b>					
		<b>114 560 (*)</b>	14	0,049	1	<b>€ 66,00</b>	
<p>COPPIA ANTE MEDIE SUPERIORI SENZA SERRATURA (REVERSIBILE IN POSIZIONE BASSA) <i>set of 2 upper medium wooden door without lock (reversible in lower place)</i></p>		<b>SENZA SERRATURA without lock</b>					
		<b>114 561 (*)</b>	14	0,049	1	<b>€ 60,00</b>	
<p>COPPIA ANTE MEDIE CON SERRATURA H.119,8 (ANCHE PER MOBILI ALTI IN POSIZIONE BASSA) <i>set of 2 medium wooden door with lock H.119,8 (for high cabinets in lower place, too)</i></p>		<b>CON SERRATURA with lock</b>					
		<b>114 559 (*)</b>	14	0,049	1	<b>€ 66,00</b>	

(*)	ANTE	doors
005	ARGENTO GOLF	<i>golf silver</i>
155	ACERO TAKI	<i>taki maple</i>
166	NOCE PAVIA	<i>pavia walnut</i>
300	GRIGIO	<i>grey</i>
305	WENGE'	<i>wenge</i>
440	BIANCO BR.	<i>br. white</i>
551	ANTRACITE	<i>anthracite</i>
611	GIALLO FRESIA	<i>freesia yellow</i>
632	AZZURRO SKY	<i>sky blue</i>
633	AMARANTO	<i>amaranth</i>
696	VERDE BOSCO	<i>wood green</i>
704	ROVERE GREY	<i>grey oak</i>
733	ROVERE	<i>oak</i>
844	STONE GREY	<i>stone grey</i>

CONTENITORI UNIVERSALI EVO  
universal cabinets EVO

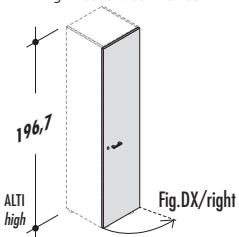
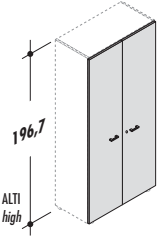
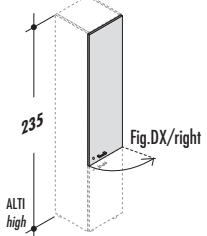
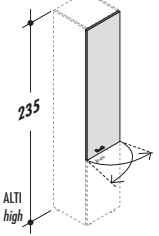
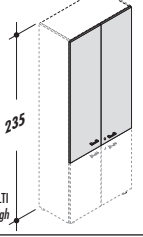
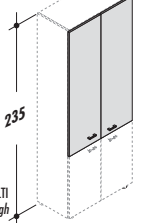
COMPLEMENTI PER CONTENITORI H.196,7- H.235 complements for cabinets h 196,7-235 cms							
DESCRIZIONE description	L w	CODICE code	KG	M <sup>3</sup>	COLLI	PREZZO price	(*) CODICE FINITURA (*) finish code
<b>ANTA ALTA CON SERRATURA</b> high wooden door with lock 	<b>CON SERRATURA</b> with lock		12	0,066	1	€ 79,00	
	<b>DX</b> right	<b>114 568 (*)</b>					
	<b>SX</b> left	<b>114 569 (*)</b>					
<b>COPPIA ANTE ALTE CON SERRATURA</b> set of 2 high wooden doors with lock 	<b>CON SERRATURA</b> with lock		24	0,084	1	€ 125,00	
		<b>114 570 (*)</b>					
<b>ANTA MEDIA SUPERIORE CON SERRATURA</b> (PER MOBILI ALTI H.235) upper medium wooden door with lock (for high cabinets h.92½") 	<b>CON SERRATURA</b> with lock		9	0,042	1	€ 53,00	
	<b>DX</b> right	<b>114 571 (*)</b>					
	<b>SX</b> left	<b>114 572 (*)</b>					
<b>ANTA MEDIA SUPERIORE DX O SX SENZA SERRATURA</b> (PER MOBILI ALTI H.235) right or left upper medium wooden door without lock (for high cabinets h.92½") 	<b>SENZA SERRATURA</b> without lock		9	0,042	1	€ 47,00	
		<b>114 573 (*)</b>					
<b>COPPIA ANTE MEDIE SUPERIORI CON SERRATURA</b> (PER MOBILI ALTI H.235) set of 2 upper medium wooden door with lock (for high cabinets h.92½") 	<b>CON SERRATURA</b> with lock		18	0,064	1	€ 85,00	
		<b>114 574 (*)</b>					
<b>COPPIA ANTE MEDIE SUPERIORI SENZA SERRATURA</b> (PER MOBILI ALTI H.235) set of 2 upper medium wooden door without lock (for high cabinets h.92½") 	<b>SENZA SERRATURA</b> without lock		18	0,064	1	€ 79,00	
		<b>114 575 (*)</b>					

(*)	ANTE	doors
005	ARGENTO GOLF	golf silver
155	ACERO TAKI	taki maple
166	NOCE PAVIA	pavia walnut
300	GRIGIO	grey
305	WENGE'	wenge
440	BIANCO BR.	br. white
551	ANTRACITE	anthracite
611	GIALLO FRESIA	freesia yellow
632	AZZURRO SKY	sky blue
633	AMARANTO	amaranth
696	VERDE BOSCO	wood green
704	ROVERE GREY	grey oak
733	ROVERE	oak
844	STONE GREY	stone grey

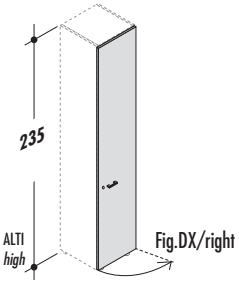
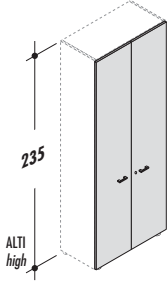
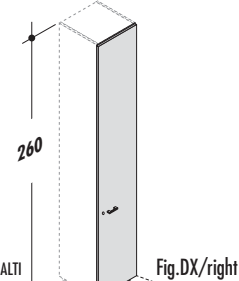
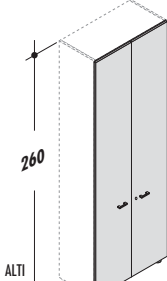
COMPLEMENTI PER CONTENITORI H.235 - H.260 complements for cabinets h. 235-260 cms							
DESCRIZIONE description	L w	CODICE code	KG	M <sup>3</sup>	COLLI	PREZZO price	(*) CODICE FINITURA (*) finish code
<p>ANTA ALTA CON SERRATURA (PER MOBILI ALTI H.235) high wooden door with lock (for high cabinets h.92½")</p> 		<b>CON SERRATURA with lock</b>					
	DX right	114 576 (*)	17	0,063	1	€ 90,00	
SX left	114 577 (*)						
<p>COPPIA ANTE ALTE CON SERRATURA (PER MOBILI ALTI H.235) set of 2 high wooden doors with lock (for high cabinets h.92½")</p> 		<b>CON SERRATURA with lock</b>					
		114 578 (*)	35	0,086	1	€ 145,00	
<p>ANTA ALTA CON SERRATURA (PER MOBILI ALTI H.260) high wooden door with lock (for high cabinets h.102½")</p> 		<b>CON SERRATURA with lock</b>					
	DX right	114 579 (*)	20	0,095	1	€ 96,00	
SX left	114 580 (*)						
<p>COPPIA ANTE ALTE CON SERRATURA (PER MOBILI ALTI H.260) set of 2 high wooden doors with lock (for high cabinets h.102½")</p> 		<b>CON SERRATURA with lock</b>					
		114 581 (*)	40	0,120	1	€ 157,00	

(*)	ANTE	doors
005	ARGENTO GOLF	golf silver
155	ACERO TAKI	taki maple
166	NOCE PAVIA	pavia walnut
300	GRIGIO	grey
305	WENGE'	wenge
440	BIANCO BR.	br. white
551	ANTRACITE	anthracite
611	GIALLO FRESIA	freesia yellow
632	AZZURRO SKY	sky blue
633	AMARANTO	amaranth
696	VERDE BOSCO	wood green
704	ROVERE GREY	grey oak
733	ROVERE	oak
844	STONE GREY	stone grey

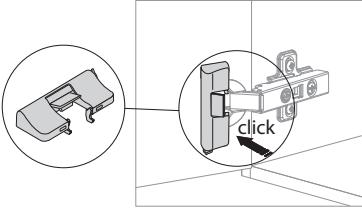
KIT AMMORTIZZATORI (PER ANTE LEGNO) dampers set (for wooden doors)													
DESCRIZIONE description	L W	CODICE code	KG	M <sup>3</sup>	COLLI	PREZZO price	(*) CODICE FINITURA (*) finish code						
 <p>KIT AMMORTIZZATORI PER ANTE LEGNO dampers kit for soft-close wooden doors</p>	1 Pz.	114 354 (*)	1	0,001	1	€ 8,00	<table border="1"> <tr> <td>(*)</td> <td></td> <td></td> </tr> <tr> <td>000</td> <td>ARGENTO</td> <td>silver</td> </tr> </table>	(*)			000	ARGENTO	silver
	(*)												
	000	ARGENTO	silver										
	2 Pz.	114 355 (*)	1	0,001	1	€ 12,00							
3 Pz.	114 356 (*)	1	0,001	1	€ 16,00								
<b>NON UTILIZZABILI SU CERNIERE A 175°!</b> not usable on hinges at 175°!													

**Applicazione ammortizzatore: / Damper application:**

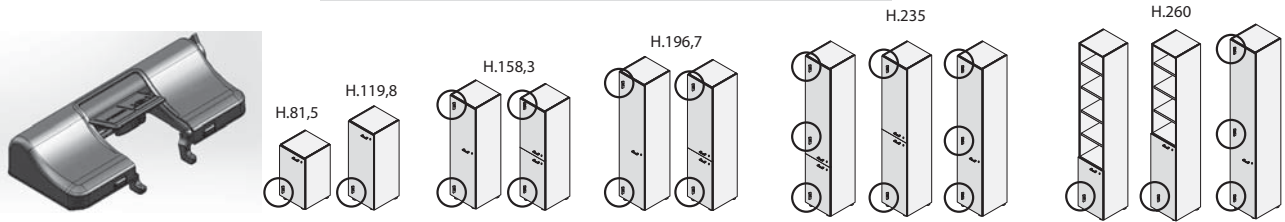

KIT BASETTE CON CERNIERE APERTURA 175° (PER ANTE LEGNO) set of cruciform metal plates with 175° opening hinges (for wooden doors)													
 <p>KIT BASETTE CON CERNIERE CON APERTURA A 175° (PER ANTE LEGNO) set of cruciform metal plates with 175° opening hinges (for wooden doors)</p>	4 Pz.	114 364 (*)	1	0,001	1	€ 29,00	<table border="1"> <tr> <td>(*)</td> <td></td> <td></td> </tr> <tr> <td>000</td> <td>ARGENTO</td> <td>silver</td> </tr> </table>	(*)			000	ARGENTO	silver
	(*)												
	000	ARGENTO	silver										
6 Pz.	114 365 (*)	1	0,001	1	€ 43,00								
													

**Utilizzo cerniere 175° / Use 175° hinges**

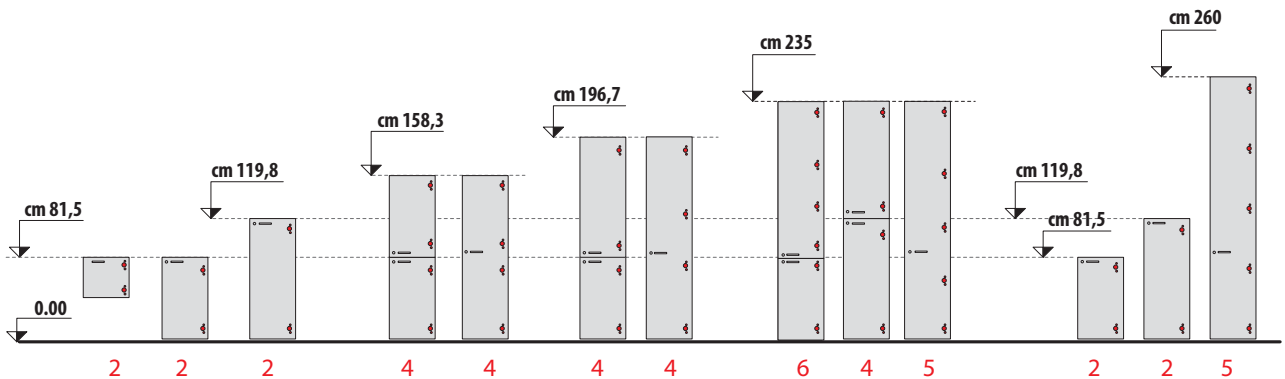

**Numero pezzi per tipologie di ante**  
units for kind of doors

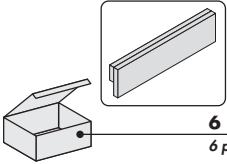
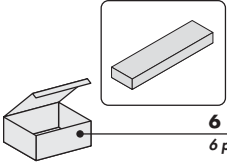
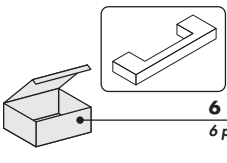

KIT MANIGLIE (PER ANTE LEGNO E CASSETTI) set of handles (for wooden doors and drawers)									
DESCRIZIONE description	L w	CODICE code	KG	M <sup>3</sup>	COLLI	PREZZO price	(*) CODICE FINITURA (*) finish code		
KIT 6 MANIGLIE (Mod. 5th element) (con viti in dotazione) set of 6 handles (5th element) (with screws)   <b>6 PEZZI</b> 6 pieces  L.12 x p.1 x H.3		114 <b>358</b> (*)	1,5	0,001	1	<b>€ 38,00</b>	(*)		
		INTERASSE 32-64mm center distance 32-64mm							
							000	ARGENTO silver	
							155	ACERO TAKI taki maple	
							166	NOCE PAVIA pavia walnut	
							305	WENGE' wenge	
							440	BIANCO BR. br. white	
							551	ANTRACITE anthracite	
							611	GIALLO FRESIA freesia yellow	
							632	AZZURRO SKY sky blue	
KIT 6 MANIGLIE CROMATE (con viti in dotazione) set of 6 chromed handles (with screws)   <b>6 PEZZI</b> 6 pieces  L.10 x p.1,6 x H.0,8		114 <b>360</b> (*)	1,5	0,001	1	<b>€ 13,00</b>	(*)		
		INTERASSE 64mm center distance 64mm							
							000	CROMO chrome	
	KIT 6 MANIGLIE (con viti in dotazione) set of 6 handles (with screws)   <b>6 PEZZI</b> 6 pieces  L.9 x p.2,6 x H.1		114 <b>361</b> (*)	1,5	0,001	1	<b>€ 11,00</b>	(*)	
			INTERASSE 64mm center distance 64mm						
								000	ARGENTO silver
								166	NOCE PAVIA pavia walnut
								305	WENGE' wenge
								440	BIANCO white
								551	ANTRACITE anthracite
							611	GIALLO FRESIA freesia yellow	
							632	AZZURRO SKY sky blue	
							633	AMARANTO amaranth	
						696	VERDE BOSCO wood green		
						704	ROVERE GREY grey oak		
						733	ROVERE (ACERO TAKI) oak (taki maple)		
						844	STONE GREY stone grey		

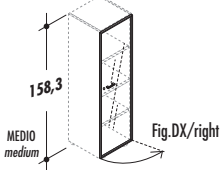
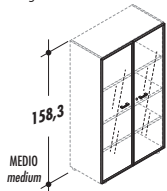
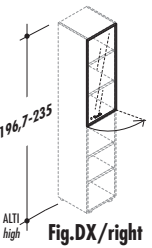
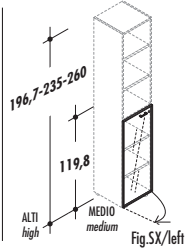
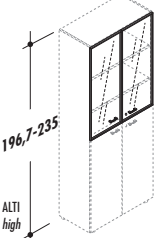
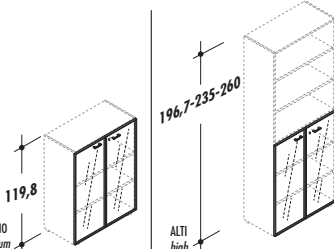
ANTE VETRO TEMPERATO SATINATO CON TELAIO <i>tempered satined glass doors with metal frame</i>							
DESCRIZIONE <i>description</i>	L <i>w</i>	CODICE <i>code</i>	KG	M <sup>3</sup>	COLLI	PREZZO <i>price</i>	(*) CODICE FINITURA <i>(*) finish code</i>
ANTA MEDIA VETRO CON SERRATURA PER MOBILI H.158,3 <i>medium glass door with lock for cabinet 62¼"</i> 		<b>CON SERRATURA with lock</b>		<b>VETRO TEMPERATO SATINATO tempered satined glass</b>			
	DX <i>right</i>	114 <b>695</b> (*)	12	0,042	2	€ 134,00	
	SX <i>left</i>	114 <b>696</b> (*)					
COPPIA ANTE MEDIE VETRO CON SERRATURA PER MOBILI H.158,3 <i>set of 2 medium glass doors with lock for cabinet 62¼"</i> 		<b>CON SERRATURA with lock</b>		<b>VETRO TEMPERATO SATINATO tempered satined glass</b>			
		114 <b>705</b> (*)	23	0,083	3	€ 265,00	
ANTA MEDIA VETRO SUPERIORE DX CON SERRATURA (REVERSIBILE SX IN POSIZIONE BASSA) <i>right medium glass door with lock (left reversible for lower place)</i> 		<b>CON SERRATURA with lock</b>		<b>VETRO TEMPERATO SATINATO tempered satined glass</b>			
	DX <i>right</i>	114 <b>702</b> (*)	9	0,033	2	€ 107,00	
ANTA MEDIA VETRO SUPERIORE SX CON SERRATURA (REVERSIBILE DX IN POSIZIONE BASSA) <i>left medium glass door with lock (right reversible for lower place)</i> 		<b>CON SERRATURA with lock</b>		<b>VETRO TEMPERATO SATINATO tempered satined glass</b>			
	SX <i>left</i>	114 <b>703</b> (*)	9	0,033	2	€ 107,00	
COPPIA ANTE VETRO SUPERIORI CON SERRATURA PER MOBILI ALTI <i>set of 2 upper glass doors with lock for high cabinet</i> 		<b>CON SERRATURA with lock</b>		<b>VETRO TEMPERATO SATINATO tempered satined glass</b>			
		114 <b>704</b> (*)	17	0,064	3	€ 210,00	
COPPIA ANTE MEDIE VETRO CON SERRATURA H.119,8 (ANCHE PER MOBILI ALTI IN POSIZIONE BASSA) <i>set of 2 medium glass door with lock H.119,8 (for high cabinets in lower place, too)</i> 		<b>CON SERRATURA with lock</b>		<b>VETRO TEMPERATO SATINATO tempered satined glass</b>			
		114 <b>716</b> (*)	17	0,064	3	€ 210,00	

(*)	ANTE	doors
000	TELAIO ALLUMINIO	aluminium frame



**ANTE VETRO TEMPERATO SATINATO CON TELAIO**

*tempered satinated glass doors with metal frame*

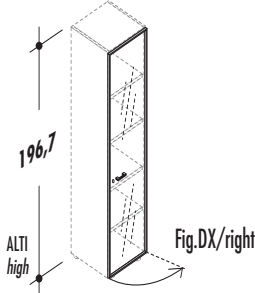
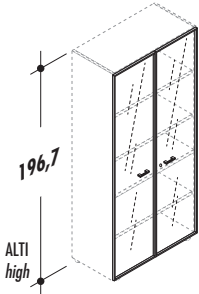
DESCRIZIONE <i>description</i>	L <i>w</i>	CODICE <i>code</i>	KG	M <sup>2</sup>	COLLI	PREZZO <i>price</i>	(*) CODICE FINITURA <i>(*) finish code</i>
ANTA ALTA VETRO CON SERRATURA <i>high glass door with lock</i> 	<b>CON SERRATURA with lock</b>		<b>VETRO TEMPERATO SATINATO tempered satinated glass</b>				
	DX <i>right</i> SX <i>left</i>	114 <b>710</b> (*) 114 <b>711</b> (*)	15	0,051	2	€ 147,00	
COPPIA ANTE ALTE VETRO CON SERRATURA <i>set of 2 high glass doors with lock</i> 	<b>CON SERRATURA with lock</b>		<b>VETRO TEMPERATO SATINATO tempered satinated glass</b>				
		114 <b>714</b> (*)	29	0,103	3	€ 296,00	
							(*) ANTE <i>doors</i> 000 TELAIO ALLUMINIO <i>aluminium frame</i>

**ANTE IN VETRO TEMPERATO TRASPARENTE SENZA TELAIO**  
*tempered transparent glass doors without metallic frame*

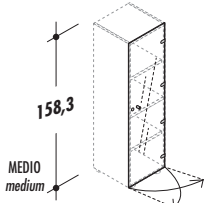
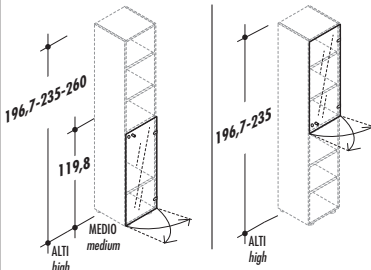
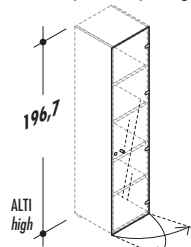
ANTA MEDIA VETRO TEMPERATO TRASPARENTE DX O SX PER MOBILI H.158,3 <i>medium right or left tempered transparent glass door for cabinet h.158,3</i> 	<b>CON SERRATURA with lock</b>		114 <b>691</b> (*) 11 0,054 2 € 95,00				
	<b>SENZA SERRATURA without lock</b>		114 <b>690</b> (*) 10 0,055 2 € 83,00				
ANTA VETRO TEMPERATO TRASPARENTE DX O SX SUPERIORE PER MOBILI ALTI <i>upper right or left tempered transparent glass door for high cabinets</i> 	<b>CON SERRATURA with lock</b>		114 <b>689</b> (*) 8 0,041 2 € 76,00				(*) VETRO TEMPERATO TRASPARENTE <i>transparent tempered glass</i>
	<b>SENZA SERRATURA without lock</b>		114 <b>692</b> (*) 8 0,041 2 € 66,00				
ANTA ALTA VETRO TEMPERATO TRASPARENTE DX O SX <i>high right or left tempered transparent glass door</i> 	<b>CON SERRATURA with lock</b>		114 <b>694</b> (*) 14 0,066 2 € 110,00				
	<b>SENZA SERRATURA without lock</b>		114 <b>693</b> (*) 13 0,067 2 € 99,00				

CONTENITORI UNIVERSALI EVO  
UNIVERSAL CABINETS EVO

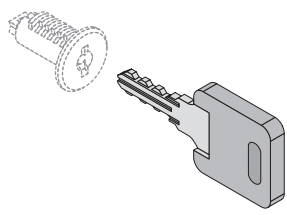
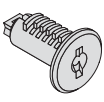
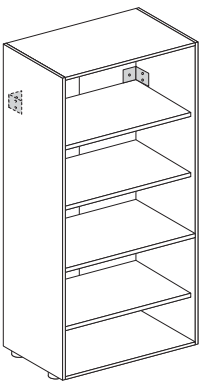
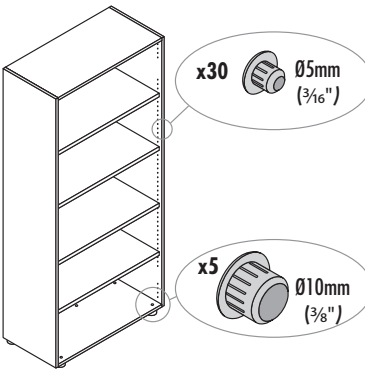

KIT CILINDRO SERRATURA PER CHIAVI UGUALI cylinder lock kit for keys alike								
DESCRIZIONE description	L w	CODICE code	KG	M <sup>3</sup>	COLLI	PREZZO price	(*) CODICE FINITURA (*) finish code	
CHIAVE PER ESTRAZIONE CILINDRO SERRATURA key for extraction cylinder lock  		171 058 (*)	0,1	0,001	1	€ 10,00		
CILINDRO SERRATURA ESTRAIBILE PER CHIAVI UGUALI +2 CHIAVI PIEGHEVOLI extractable cylinder lock for keys alike + 2 folding keys    <b>ATTENZIONE! PER L'ESTRAZIONE DEL CILINDRO, OCCORRE SEMPRE UTILIZZARE LA CHIAVE ART.058</b> attention! for extraction of the cylinder, always use the key art.058		171 059 (*)	0,1	0,001	1	€ 9,00	(*) 999 ZINCATO zinc plated	
	<b>PER TUTTE LE ANTE LEGNO, VETRO, CASSETTIERE E MOBILI</b> for all wooden doors, glass doors, pedestals and cabinets							
KIT FISSAGGIO A MURO wall fixing kit								
KIT FISSAGGIO A MURO PER MOBILI wall fixing kit for cabinets  		114 980 (*)	1	0,001	1	€ 14,00	(*) 000 ARGENTO silver	
	<b>IL KIT DI FISSAGGIO ,VA SEMPRE UTILIZZATO IN PRESENZA DEL RISCHIO DI RIBALTAMENTO CONSEQUENTE ALLE FORZE GENERATE DAI CARICHI APPLICATI E/O DALLE MODALITA' D'USO DEL MOBILE</b> the fixing kit, must always be used in the presence of the risk of tipping the forces generated by subsequent loads applied and / or from method of use of cabinet							
KIT TAPPI COPRIFORI PER MOBILI set of hole cover caps for cabinets								
KIT TAPPI COPRIFORI PER MOBILI set of hole cover caps for cabinets  		171 088 (*)	0,1	0,001	1	€ 5,00	(*) 000 ARGENTO silver	
							006 NOCE PAVIA pavia walnut	
							044 STONE GREY stone grey	
							055 ANTRACITE anthracite	
						069 BIANCO white		

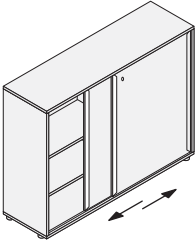
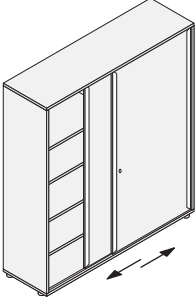
CONTENITORI CON ANTE SCORREVOLI cabinets with sliding doors								
DESCRIZIONE description	L w	CODICE code	KG	M <sup>3</sup>	COLLI	PREZZO price	(*) CODICE FINITURA (*) finish code	
<b>MOBILE MEDIO CON ANTE SCORREVOLI CON SERRATURA</b> <b>medium cabinet with sliding doors with lock</b>    L.180,5 x p.49,1 x <b>H.121,6</b>								
			<b>CON SERRATURA with lock</b>					
			<b>114 986 (*)</b>	151	0,393	<b>7</b>	<b>€ 648,00</b>	
								VERSIONE MONO-COLORE / single-color version
								(*)
			<b>005</b>	ARGENTO GOLF			golf silver	
			<b>166</b>	NOCE PAVIA			pavia walnut	
			<b>440</b>	BIANCO BR.			br. white	
			<b>551</b>	ANTRACITE			anthracite	
			<b>844</b>	STONE GREY			stone grey	
<b>MOBILE ALTO CON ANTE SCORREVOLI CON SERRATURA</b> <b>high cabinet with sliding doors with lock</b>    L.180,5 x p.49,1 x <b>H.198,5</b>								
			<b>CON SERRATURA with lock</b>					
			<b>114 987 (*)</b>	207	0,570	<b>8</b>	<b>€ 911,00</b>	
								VERSIONE BI-COLORE / double-color version
								(*) ANTE STRUTTURA doors structure
			<b>003</b>	ROVERE ARGENTO GOLF	oak golf silver			
			<b>004</b>	ROVERE GREY ARGENTO GOLF	grey oak golf silver			
			<b>015</b>	ACERO TAKI ARGENTO GOLF	taki maple golf silver			
			<b>025</b>	GRIGIO ARGENTO GOLF	grey golf silver			
			<b>030</b>	WENGE' ARGENTO GOLF	wenge golf silver			
			<b>040</b>	BIANCO BR. ARGENTO GOLF	br. white golf silver			
			<b>044</b>	STONE GREY ARGENTO GOLF	stone grey golf silver			
			<b>051</b>	ANTRACITE ARGENTO GOLF	anthracite golf silver			
			<b>066</b>	NOCE PAVIA ARGENTO GOLF	pavia walnut golf silver			
			<b>403</b>	ROVERE BIANCO BR.	oak br. white			
			<b>404</b>	ROVERE GREY BIANCO BR.	grey oak br. white			
			<b>405</b>	ARGENTO GOLF BIANCO BR.	golf silver br. white			
			<b>415</b>	ACERO TAKI BIANCO BR.	taki maple br. white			
			<b>430</b>	WENGE' BIANCO BR.	wenge br. white			
			<b>444</b>	STONE GREY BIANCO BR.	stone grey br. white			
			<b>451</b>	ANTRACITE BIANCO BR.	anthracite br. white			
			<b>466</b>	NOCE PAVIA BIANCO BR.	pavia walnut br. white			
			<b>503</b>	ROVERE ANTRACITE	oak anthracite			
			<b>504</b>	ROVERE GREY ANTRACITE	grey oak anthracite			
			<b>506</b>	ARGENTO GOLF ANTRACITE	golf silver anthracite			
			<b>516</b>	ACERO TAKI ANTRACITE	taki maple anthracite			
			<b>531</b>	WENGE' ANTRACITE	wenge anthracite			
			<b>541</b>	BIANCO BR. ANTRACITE	br. white anthracite			
			<b>544</b>	STONE GREY ANTRACITE	stone grey anthracite			
			<b>566</b>	NOCE PAVIA ANTRACITE	pavia walnut anthracite			
		<b>803</b>	ROVERE STONE GREY	oak stone grey				
		<b>804</b>	ROVERE GREY STONE GREY	grey oak stone grey				
		<b>805</b>	ARGENTO GOLF STONE GREY	golf silver stone grey				
		<b>815</b>	ACERO TAKI STONE GREY	taki maple stone grey				
		<b>830</b>	WENGE' STONE GREY	wenge stone grey				
		<b>840</b>	BIANCO BR. STONE GREY	br. white stone grey				
		<b>851</b>	ANTRACITE STONE GREY	anthracite stone grey				
		<b>866</b>	NOCE PAVIA STONE GREY	pavia walnut stone grey				

NEW

**LIBRERIE SPALLA UNICA H.235**  
*bookcases with shared side panel h.235 cms*

COMPLETARE SEMPRE LA COMPOSIZIONE CON 1 MODULO TERMINALE + N...MODULI CENTRALI  
 to be always complete the composition with 1 terminal module + n...central modules

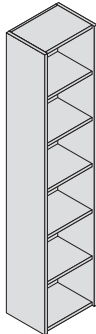
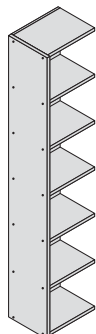
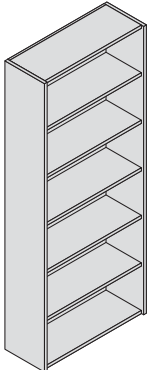
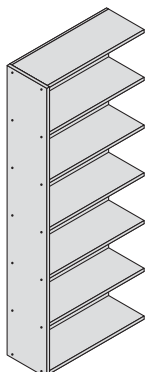
DESCRIZIONE <i>description</i>	L <i>w</i>	CODICE <i>code</i>	KG	M <sup>3</sup>	COLLI	PREZZO <i>price</i>	(*) CODICE FINITURA <i>(*) finish code</i>
MODULO TERMINALE L.45 <i>terminal module w 45 cms</i>  L.50 x p.36,9 x H.235		114 718 (*)	59	0,133	4	€ 317,00	
CARCASSA PER ANTE SPEZZATE LEGNO E TUTTE LE TIPOLOGIE DI ANTE VETRO <i>structure for split wooden doors and all types glass doors</i>							
MODULO CENTRALE L.45 <i>central module w 45 cms</i>  L.47,5 x p.36,9 x H.235		114 722 (*)	55	0,126	4	€ 263,00	
CARCASSA PER ANTE SPEZZATE LEGNO E TUTTE LE TIPOLOGIE DI ANTE VETRO <i>structure for split wooden doors and all types glass doors</i>							
MODULO TERMINALE L.90 <i>terminal module w 90 cms</i>  L.95 x p.36,9 x H.235		114 724 (*)	88	0,200	4	€ 417,00	
CARCASSA PER ANTE SPEZZATE LEGNO E TUTTE LE TIPOLOGIE DI ANTE VETRO <i>structure for split wooden doors and all types glass doors</i>							
MODULO CENTRALE L.90 <i>central module w 90 cms</i>  L.92,5 x p.36,9 x H.235		114 728 (*)	82	0,186	4	€ 363,00	
CARCASSA PER ANTE SPEZZATE LEGNO E TUTTE LE TIPOLOGIE DI ANTE VETRO <i>structure for split wooden doors and all types glass doors</i>							

(*)	STRUTTURA	structure
005	ARGENTO GOLF	golf silver
166	NOCE PAVIA	pavia walnut
440	BIANCO BR.	br. white
551	ANTRACITE	anthracite
844	STONE GREY	stone grey

PER ESEMPI DI AGGREGAZIONE E COMPLEMENTI  
 VEDI DA PAG.46 A PAG.52  
*for examples of connection and complements, please you see from page 46 to page 52*

NEW

**LIBRERIE SPALLA UNICA H.270**  
*bookcases with shared side panel h.270 cms*

COMPLETARE SEMPRE LA COMPOSIZIONE CON 1 MODULO TERMINALE + N...MODULI CENTRALI  
 to be always complete the composition with 1 terminal module + n...central modules

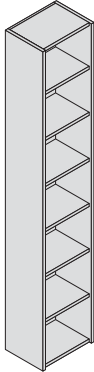
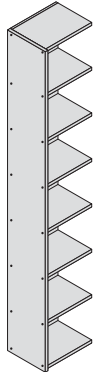
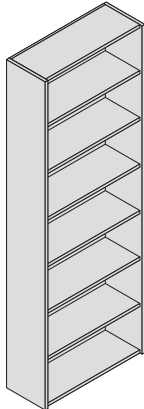
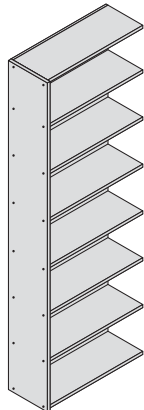
DESCRIZIONE <i>description</i>	L <i>w</i>	CODICE <i>code</i>	KG	M <sup>3</sup>	COLLI	PREZZO <i>price</i>	(*) CODICE FINITURA <i>(*) finish code</i>
MODULO TERMINALE L.45 <i>terminal module w 45 cms</i>  L.50 x p.36,9 x H.270		114 729 (*)	75	0,150	4	€ 355,00	
		CARCASSA PER ANTE SPEZZATE LEGNO E TUTTE LE TIPOLOGIE DI ANTE VETRO <i>structure for split wooden doors and all types glass doors</i>					
MODULO CENTRALE L.45 <i>central module w 45 cms</i>  L.47,5 x p.36,9 x H.270		114 731 (*)	70	0,140	4	€ 294,00	
		CARCASSA PER ANTE SPEZZATE LEGNO E TUTTE LE TIPOLOGIE DI ANTE VETRO <i>structure for split wooden doors and all types glass doors</i>					
MODULO TERMINALE L.90 <i>terminal module w 90 cms</i>  L.95 x p.36,9 x H.270		114 732 (*)	107	0,260	4	€ 478,00	
		CARCASSA PER ANTE SPEZZATE LEGNO E TUTTE LE TIPOLOGIE DI ANTE VETRO <i>structure for split wooden doors and all types glass doors</i>					
MODULO CENTRALE L.90 <i>central module w 90 cms</i>  L.92,5 x p.36,9 x H.270		114 733 (*)	100	0,220	4	€ 417,00	
		CARCASSA PER ANTE SPEZZATE LEGNO E TUTTE LE TIPOLOGIE DI ANTE VETRO <i>structure for split wooden doors and all types glass doors</i>					

(*)	STRUTTURA	structure
005	ARGENTO GOLF	<i>golf silver</i>
166	NOCE PAVIA	<i>pavia walnut</i>
440	BIANCO BR.	<i>br. white</i>
551	ANTRACITE	<i>anthracite</i>
844	STONE GREY	<i>stone grey</i>

PER ESEMPI DI AGGREGAZIONE E COMPLEMENTI  
 VEDI DA PAG.46 A PAG.52  
*for examples of connection and complements, please you see from page 46 to page 52*

CONTENITORI  
 UNIVERSALI EVO  
 universal cabinets EVO

NEW

**ESEMPI DI AGGREGAZIONE LIBRERIE SPALLA UNICA**  
examples of connection bookcases with shared side panel

LEGENDA	
key list	
<b>A</b>	<b>MODULO TERMINALE (CON 2 FIANCHI FINALI)</b> terminal module (with 2 final side panels)
<b>B</b>	<b>MODULO CENTRALE (CON FIANCO INTERMEDIO)</b> central module (with central panel)

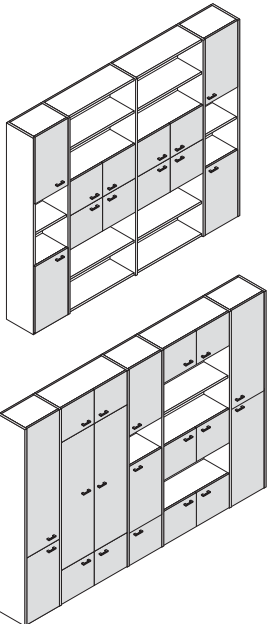
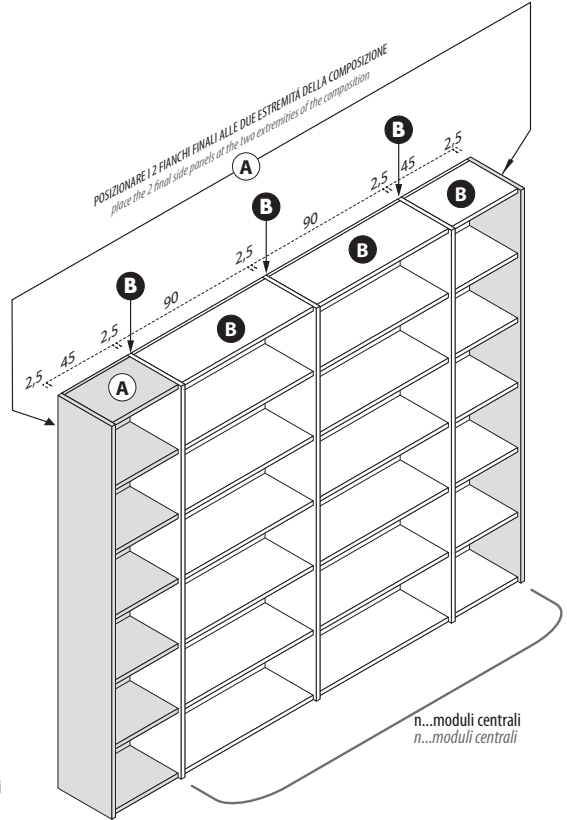
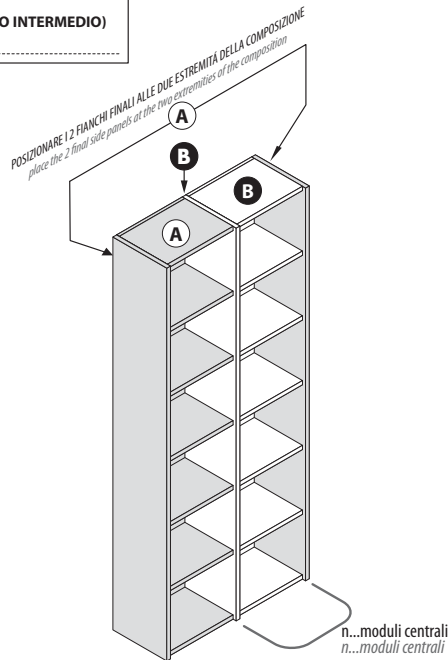
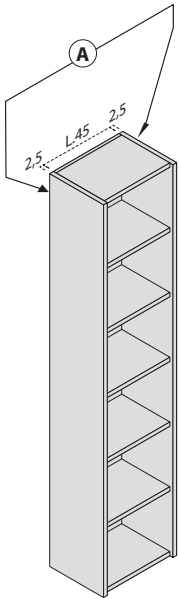

ABACO PER UTILIZZO A **SCHEMA LIBERO**  
DI ANTE PER LIBRERIE SPALLA UNICA  
*abacus of open pattern use of wooden doors  
on bookcases with shared side panels*

ANTE POSIZIONABILI LIBERAMENTE IN ALTEZZA  
USO SINGOLO O COMBINATO  
doors can be used freely in height  
(single or combined use)

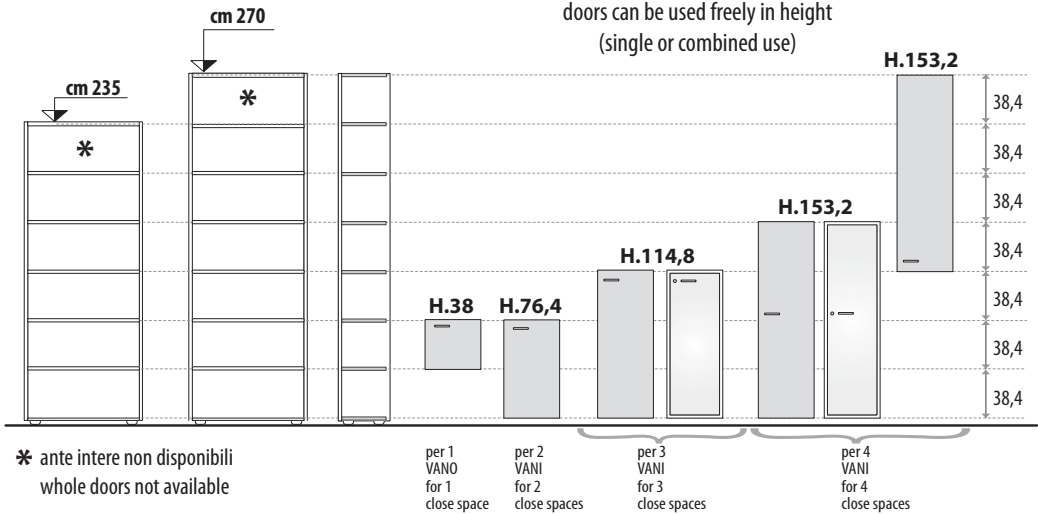



NEW

**BUSSOLOTTO PER LIBRERIE SPALLA UNICA**

modular unit for bookcases with shared side panel

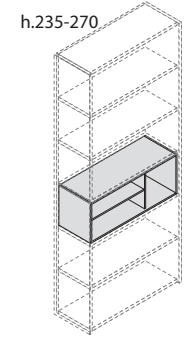
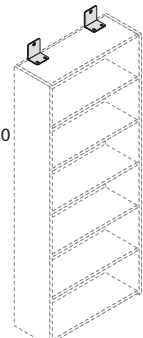
DESCRIZIONE description	L w	CODICE code	KG	M <sup>3</sup>	COLLI	PREZZO price	(*) CODICE FINITURA (*) finish code	
<p>BUSSOLOTTO L.90 PER LIBRERIE SPALLA UNICA modular unit w 90 cms for bookcases with shared side panel</p>  <p>L.90 x p.33 x H.35,8</p>								
		114 954 (*)	15	0,232	1	€ 141,00		
							(*)	
							440 BIANCO BR. br. white	
							551 ANTRACITE anthracite	
<p>KIT FISSAGGIO A MURO PER LIBRERIE SPALLA UNICA wall fixing kit for cabinets with shared element</p>  <p>h.235-270</p>								
		114 981 (*)	1	0,001	1	€ 14,00		
	<p><b>IL KIT DI FISSAGGIO ,VA SEMPRE UTILIZZATO IN PRESENZA DEL RISCHIO DI RIBALTAMENTO CONSEGUENTE ALLE FORZE GENERATE DAI CARICHI APPLICATI E/O DALLE MODALITA' D'USO DEL MOBILE</b> the fixing kit, must always be used in the presence of the risk of tipping the forces generated by subsequent loads applied and / or from method of use of cabinet</p>							
							(*)	
							000 ARGENTO silver	

CONTENITORI  
UNIVERSALI EVO  
universal cabinets evo

NEW

**ANTE LEGNO (H.38-76,4 CM) PER LIBRERIE SPALLA UNICA**

wooden doors (H.38-76,4 cms) for bookcases with shared side panel

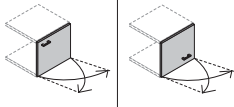
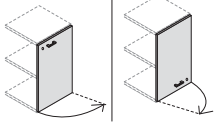
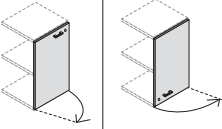
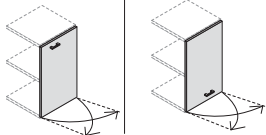
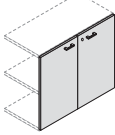
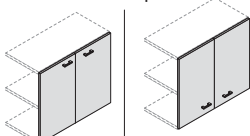
DESCRIZIONE description	L w	CODICE code	KG	M <sup>3</sup>	COLLI	PREZZO price	(*) CODICE FINITURA (*) finish code																																													
<p>1 ANTA BASSA DX O SX SENZA SERRATURA (REVERSIBILE) 1 low wooden door without lock (reversible) PER 1 VANO for 1 close space</p>  <p>H.38</p>		<p>SENZA SERRATURA without lock</p> <p>114 924 (*)</p>	4,5	0,009	1	€ 20,00																																														
<p>ANTA BASSA DX CON SERRATURA (REVERSIBILE SX PER SOVRAPPOSIZIONE) low right wooden door with lock (left reversible for superimposition) PER 2 VANI for 2 close spaces</p>  <p>H.76,4</p>	DX right	<p>CON SERRATURA with lock</p> <p>114 925 (*)</p>	5	0,022	1	€ 34,00																																														
<p>ANTA BASSA SX CON SERRATURA (REVERSIBILE DX PER SOVRAPPOSIZIONE) low left wooden door with lock (right reversible for superimposition) PER 2 VANI for 2 close spaces</p>  <p>H.76,4</p>	SX left	<p>CON SERRATURA with lock</p> <p>114 926 (*)</p>	5	0,022	1	€ 34,00	<table border="1"> <thead> <tr> <th>(*)</th> <th>ANTE</th> <th>doors</th> </tr> </thead> <tbody> <tr><td>005</td><td>ARGENTO GOLF</td><td>golf silver</td></tr> <tr><td>155</td><td>ACERO TAKI</td><td>taki maple</td></tr> <tr><td>166</td><td>NOCE PAVIA</td><td>pavia walnut</td></tr> <tr><td>300</td><td>GRIGIO</td><td>grey</td></tr> <tr><td>305</td><td>WENGE'</td><td>wenge</td></tr> <tr><td>440</td><td>BIANCO BR.</td><td>br. white</td></tr> <tr><td>551</td><td>ANTRACITE</td><td>anthracite</td></tr> <tr><td>611</td><td>GIALLO FRESIA</td><td>freesia yellow</td></tr> <tr><td>632</td><td>AZZURRO SKY</td><td>sky blue</td></tr> <tr><td>633</td><td>AMARANTO</td><td>amaranth</td></tr> <tr><td>696</td><td>VERDE BOSCO</td><td>wood green</td></tr> <tr><td>704</td><td>ROVERE GREY</td><td>grey oak</td></tr> <tr><td>733</td><td>ROVERE</td><td>oak</td></tr> <tr><td>844</td><td>STONE GREY</td><td>stone grey</td></tr> </tbody> </table>	(*)	ANTE	doors	005	ARGENTO GOLF	golf silver	155	ACERO TAKI	taki maple	166	NOCE PAVIA	pavia walnut	300	GRIGIO	grey	305	WENGE'	wenge	440	BIANCO BR.	br. white	551	ANTRACITE	anthracite	611	GIALLO FRESIA	freesia yellow	632	AZZURRO SKY	sky blue	633	AMARANTO	amaranth	696	VERDE BOSCO	wood green	704	ROVERE GREY	grey oak	733	ROVERE	oak	844	STONE GREY	stone grey
(*)	ANTE	doors																																																		
005	ARGENTO GOLF	golf silver																																																		
155	ACERO TAKI	taki maple																																																		
166	NOCE PAVIA	pavia walnut																																																		
300	GRIGIO	grey																																																		
305	WENGE'	wenge																																																		
440	BIANCO BR.	br. white																																																		
551	ANTRACITE	anthracite																																																		
611	GIALLO FRESIA	freesia yellow																																																		
632	AZZURRO SKY	sky blue																																																		
633	AMARANTO	amaranth																																																		
696	VERDE BOSCO	wood green																																																		
704	ROVERE GREY	grey oak																																																		
733	ROVERE	oak																																																		
844	STONE GREY	stone grey																																																		
<p>ANTA BASSA DX O SX SENZA SERRATURA (REVERSIBILE PER SOVRAPPOSIZIONE) low right or left wooden door without lock (reversible for superimposition) PER 2 VANI for 2 close spaces</p>  <p>H.76,4</p>		<p>SENZA SERRATURA without lock</p> <p>114 927 (*)</p>	5	0,022	1	€ 28,00																																														
<p>COPPIA ANTE BASSE CON SERRATURA set of 2 low wooden doors with lock PER 2 VANI for 2 close spaces</p>  <p>H.76,4</p>		<p>CON SERRATURA with lock</p> <p>114 928 (*)</p>	10	0,033	1	€ 57,00																																														
<p>COPPIA ANTE BASSE SENZA SERRATURA (REVERSIBILE PER SOVRAPPOSIZIONE) set of 2 low wooden doors without lock (reversible for superimposition) PER 2 VANI for 2 close spaces</p>  <p>H.76,4</p>		<p>SENZA SERRATURA without lock</p> <p>114 929 (*)</p>	10	0,033	1	€ 51,00																																														



NEW

**ANTE LEGNO (H.114,8 CM) PER LIBRERIE SPALLA UNICA**  
wooden doors (H.114,8 cms) for bookcases with shared side panel

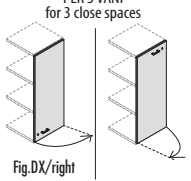
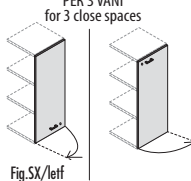
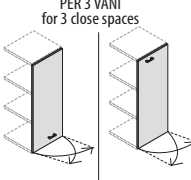
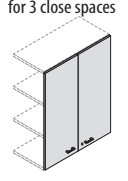
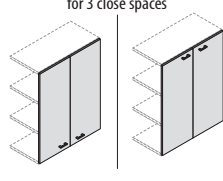
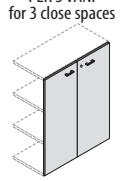
DESCRIZIONE description	L w	CODICE code	KG	M <sup>3</sup>	COLLI	PREZZO price	(*) CODICE FINITURA (*) finish code
<p>ANTA MEDIA SUPERIORE DX CON SERRATURA (REVERSIBILE SX IN POSIZIONE BASSA) right medium wooden door with lock (left reversible for lower place)</p> <p>PER 3 VANI for 3 close spaces</p>  <p>Fig.DX/right</p> <p>H.114,8</p>		CON SERRATURA with lock					
	DX right	114 930 (*)	7	0,030	1	€ 41,00	
<p>ANTA MEDIA SUPERIORE SX CON SERRATURA (REVERSIBILE DX IN POSIZIONE BASSA) left medium wooden door with lock (right reversible for lower place)</p> <p>PER 3 VANI for 3 close spaces</p>  <p>Fig.SX/left</p> <p>H.114,8</p>		CON SERRATURA with lock					
	SX left	114 931 (*)	7	0,030	1	€ 41,00	
<p>ANTA MEDIA SUPERIORE DX O SX SENZA SERRATURA (REVERSIBILE) upper medium right or left wooden door without lock (reversible)</p> <p>PER 3 VANI for 3 close spaces</p>  <p>H.114,8</p>		SENZA SERRATURA without lock					
		114 932 (*)	7	0,030	1	€ 34,00	
<p>COPPIA ANTE MEDIE SUPERIORI CON SERRATURA set of 2 upper medium wooden door with lock</p> <p>PER 3 VANI for 3 close spaces</p>  <p>H.114,8</p>		CON SERRATURA with lock					
		114 933 (*)	14	0,049	1	€ 72,00	
<p>COPPIA ANTE MEDIE SUPERIORI SENZA SERRATURA (REVERSIBILE) set of 2 upper medium wooden door with lock (reversible)</p> <p>PER 3 VANI for 3 close spaces</p>  <p>H.114,8</p>		SENZA SERRATURA without lock					
		114 934 (*)	14	0,049	1	€ 66,00	
<p>COPPIA ANTE MEDIE CON SERRATURA set of 2 medium wooden door with lock</p> <p>PER 3 VANI for 3 close spaces</p>  <p>H.114,8</p>		CON SERRATURA with lock					
		114 935 (*)	14	0,049	1	€ 72,00	

(*)	ANTE	doors
005	ARGENTO GOLF	golf silver
155	ACERO TAKI	taki maple
166	NOCE PAVIA	pavia walnut
300	GRIGIO	grey
305	WENGE'	wenge
440	BIANCO BR.	br. white
551	ANTRACITE	anthracite
611	GIALLO FRESIA	freesia yellow
632	AZZURRO SKY	sky blue
633	AMARANTO	amaranth
696	VERDE BOSCO	wood green
704	ROVERE GREY	grey oak
733	ROVERE	oak
844	STONE GREY	stone grey

CONTENITORI UNIVERSALI EVO  
universal cabinets EVO



**NEW**

**ANTE LEGNO (H.153,2 CM) PER LIBRERIE SPALLA UNICA**  
wooden doors (H.153,2 cms) for bookcases with shared side panel

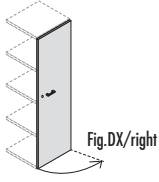
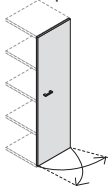
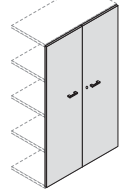
DESCRIZIONE <i>description</i>	L <i>w</i>	CODICE <i>code</i>	KG	M <sup>3</sup>	COLLI	PREZZO <i>price</i>	(*) CODICE FINITURA <i>(*) finish code</i>																																													
ANTA MEDIA CON SERRATURA medium wooden door with lock PER 4 VANI for 4 close spaces  H.153,2		<b>CON SERRATURA with lock</b>																																																		
	DX <i>right</i>	114 <b>936 (*)</b>	10	0,042	1	<b>€ 58,00</b>																																														
	SX <i>left</i>	114 <b>937 (*)</b>																																																		
ANTA MEDIA DX O SX SENZA SERRATURA right or left medium wooden door without lock PER 4 VANI for 4 close spaces  H.153,2		<b>SENZA SERRATURA without lock</b>																																																		
		114 <b>938 (*)</b>	10	0,042	1	<b>€ 52,00</b>																																														
COPPIA ANTE MEDIE set of 2 medium wooden doors PER 4 VANI for 4 close spaces  H.153,2		<b>CON SERRATURA with lock</b>																																																		
		114 <b>939 (*)</b>	20	0,064	1	<b>€ 94,00</b>																																														
		<b>SENZA SERRATURA without lock</b>																																																		
		114 <b>940 (*)</b>	20	0,064	1	<b>€ 88,00</b>																																														
							<table border="1"> <thead> <tr> <th>(*)</th> <th>ANTE</th> <th>doors</th> </tr> </thead> <tbody> <tr><td>005</td><td>ARGENTO GOLF</td><td>golf silver</td></tr> <tr><td>155</td><td>ACERO TAKI</td><td>taki maple</td></tr> <tr><td>166</td><td>NOCE PAVIA</td><td>pavia walnut</td></tr> <tr><td>300</td><td>GRIGIO</td><td>grey</td></tr> <tr><td>305</td><td>WENGE'</td><td>wenge</td></tr> <tr><td>440</td><td>BIANCO BR.</td><td>br. white</td></tr> <tr><td>551</td><td>ANTRACITE</td><td>anthracite</td></tr> <tr><td>611</td><td>GIALLO FRESIA</td><td>freesia yellow</td></tr> <tr><td>632</td><td>AZZURRO SKY</td><td>sky blue</td></tr> <tr><td>633</td><td>AMARANTO</td><td>amaranth</td></tr> <tr><td>696</td><td>VERDE BOSCO</td><td>wood green</td></tr> <tr><td>704</td><td>ROVERE GREY</td><td>grey oak</td></tr> <tr><td>733</td><td>ROVERE</td><td>oak</td></tr> <tr><td>844</td><td>STONE GREY</td><td>stone grey</td></tr> </tbody> </table>	(*)	ANTE	doors	005	ARGENTO GOLF	golf silver	155	ACERO TAKI	taki maple	166	NOCE PAVIA	pavia walnut	300	GRIGIO	grey	305	WENGE'	wenge	440	BIANCO BR.	br. white	551	ANTRACITE	anthracite	611	GIALLO FRESIA	freesia yellow	632	AZZURRO SKY	sky blue	633	AMARANTO	amaranth	696	VERDE BOSCO	wood green	704	ROVERE GREY	grey oak	733	ROVERE	oak	844	STONE GREY	stone grey
(*)	ANTE	doors																																																		
005	ARGENTO GOLF	golf silver																																																		
155	ACERO TAKI	taki maple																																																		
166	NOCE PAVIA	pavia walnut																																																		
300	GRIGIO	grey																																																		
305	WENGE'	wenge																																																		
440	BIANCO BR.	br. white																																																		
551	ANTRACITE	anthracite																																																		
611	GIALLO FRESIA	freesia yellow																																																		
632	AZZURRO SKY	sky blue																																																		
633	AMARANTO	amaranth																																																		
696	VERDE BOSCO	wood green																																																		
704	ROVERE GREY	grey oak																																																		
733	ROVERE	oak																																																		
844	STONE GREY	stone grey																																																		



NEW

**ANTE LEGNO SUPERIORI (H.153,2 CM) PER LIBRERIE SPALLA UNICA**

upper wooden doors (H.153,2 cms) for bookcases with shared side panel

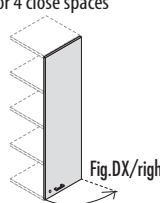
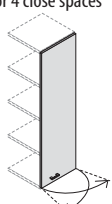
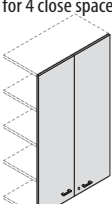
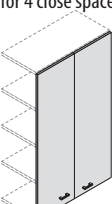
DESCRIZIONE description	L w	CODICE code	KG	M <sup>3</sup>	COLLI	PREZZO price	(*) CODICE FINITURA (*) finish code																																												
<p>ANTA MEDIA SUPERIORE CON SERRATURA upper medium wooden door with lock</p> <p>PER 4 VANI for 4 close spaces</p>  <p>Fig.DX/right</p> <p>H.153,2</p>		<b>CON SERRATURA with lock</b>																																																	
	DX right	114 <b>941</b> (*)	9	0,042	1	€ 58,00																																													
<p>ANTA MEDIA SUPERIORE DX O SX SENZA SERRATURA right or left upper medium wooden door without lock</p> <p>PER 4 VANI for 4 close spaces</p>  <p>H.153,2</p>		<b>SENZA SERRATURA without lock</b>																																																	
		114 <b>943</b> (*)	9	0,042	1	€ 52,00	<table border="1"> <thead> <tr> <th>(*)</th> <th>ANTE</th> <th>doors</th> </tr> </thead> <tbody> <tr><td>005</td><td>ARGENTO GOLF</td><td>golf silver</td></tr> <tr><td>155</td><td>ACERO TAKI</td><td>taki maple</td></tr> <tr><td>166</td><td>NOCE PAVIA</td><td>pavia walnut</td></tr> <tr><td>300</td><td>GRIGIO</td><td>grey</td></tr> <tr><td>305</td><td>WENGE'</td><td>wenge</td></tr> <tr><td>440</td><td>BIANCO BR.</td><td>br. white</td></tr> <tr><td>551</td><td>ANTRACITE</td><td>anthracite</td></tr> <tr><td>611</td><td>GIALLO FRESIA</td><td>freesia yellow</td></tr> <tr><td>632</td><td>AZZURRO SKY</td><td>sky blue</td></tr> <tr><td>633</td><td>AMARANTO</td><td>amaranth</td></tr> <tr><td>696</td><td>VERDE BOSCO</td><td>wood green</td></tr> <tr><td>704</td><td>ROVERE GREY</td><td>grey oak</td></tr> <tr><td>733</td><td>ROVERE</td><td>oak</td></tr> <tr><td>844</td><td>STONE GREY</td><td>stone grey</td></tr> </tbody> </table>	(*)	ANTE	doors	005	ARGENTO GOLF	golf silver	155	ACERO TAKI	taki maple	166	NOCE PAVIA	pavia walnut	300	GRIGIO	grey	305	WENGE'	wenge	440	BIANCO BR.	br. white	551	ANTRACITE	anthracite	611	GIALLO FRESIA	freesia yellow	632	AZZURRO SKY	sky blue	633	AMARANTO	amaranth	696	VERDE BOSCO	wood green	704	ROVERE GREY	grey oak	733	ROVERE	oak	844	STONE GREY
(*)	ANTE	doors																																																	
005	ARGENTO GOLF	golf silver																																																	
155	ACERO TAKI	taki maple																																																	
166	NOCE PAVIA	pavia walnut																																																	
300	GRIGIO	grey																																																	
305	WENGE'	wenge																																																	
440	BIANCO BR.	br. white																																																	
551	ANTRACITE	anthracite																																																	
611	GIALLO FRESIA	freesia yellow																																																	
632	AZZURRO SKY	sky blue																																																	
633	AMARANTO	amaranth																																																	
696	VERDE BOSCO	wood green																																																	
704	ROVERE GREY	grey oak																																																	
733	ROVERE	oak																																																	
844	STONE GREY	stone grey																																																	
<p>COPPIA ANTE MEDIE SUPERIORI CON SERRATURA set of 2 upper medium wooden door with lock</p> <p>PER 4 VANI for 4 close spaces</p>  <p>H.153,2</p>		<b>CON SERRATURA with lock</b>																																																	
		114 <b>944</b> (*)	18	0,064	1	€ 94,00																																													
<p>COPPIA ANTE MEDIE SUPERIORI SENZA SERRATURA set of 2 upper medium wooden door without lock</p> <p>PER 4 VANI for 4 close spaces</p>  <p>H.153,2</p>		<b>SENZA SERRATURA without lock</b>																																																	
		114 <b>945</b> (*)	18	0,064	1	€ 88,00																																													

CONTENITORI  
UNIVERSALI EVO  
universal cabinets evo

NEW

**ANTE VETRO TEMPERATO SATINATO CON TELAIO (H.114,8-153,2 CM) PER LIBRERIE SPALLA UNICA**

*tempered satined glass doors with metal frame (h.114,8-153,2 cms) for bookcases with shared side panel*

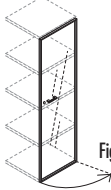
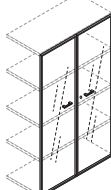
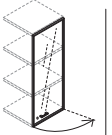
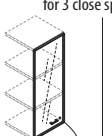
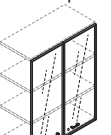
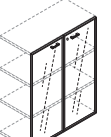
DESCRIZIONE <i>description</i>	L <i>w</i>	CODICE <i>code</i>	KG	M <sup>3</sup>	COLLI	PREZZO <i>price</i>	(*) CODICE FINITURA <i>(*) finish code</i>
ANTA MEDIA VETRO CON SERRATURA <i>medium glass door with lock</i> PER 4 VANI for 4 close spaces  Fig.DX/right H.153,2							
COPPIA ANTE MEDIE VETRO CON SERRATURA <i>set of 2 medium glass doors with lock</i> PER 4 VANI for 4 close spaces  H.153,2							
ANTA MEDIA VETRO SUPERIORE DX CON SERRATURA (REVERSIBILE SX IN POSIZIONE BASSA) <i>right medium glass door with lock (left reversible for lower place)</i> PER 3 VANI for 3 close spaces  Fig.DX/right H.114,8							
ANTA MEDIA VETRO SUPERIORE SX CON SERRATURA (REVERSIBILE DX IN POSIZIONE BASSA) <i>left medium glass door with lock (right reversible for lower place)</i> PER 3 VANI for 3 close spaces  Fig.SX/left H.114,8							
COPPIA ANTE VETRO SUPERIORI CON SERRATURA <i>set of 2 upper glass doors with lock</i> PER 3 VANI for 3 close spaces  H.114,8							
COPPIA ANTE MEDIE VETRO CON SERRATURA <i>set of 2 medium glass door with lock</i> PER 3 VANI for 3 close spaces  H.114,8							

(*)	ANTE	doors
000	TELAIO ALLUMINIO	aluminium frame



**MAGGIORAZIONI PER TAGLI A MISURA (RIDUZIONI DIMENSIONALI)**

price increase for cuts to sizes (sizes reduction)













LA MAGGIORAZIONE DEL PREZZO E' VALIDA ANCHE SU RIDUZIONI DIMENSIONALI MULTIPLE in L x P x H  
The price increase is also valid in multiple size reductions (L x P x H)

RIDUZIONI POSSIBILI - POSSIBLE REDUCTIONS REDUCCIONES POSSIBLES - REDUCCIONES POSIBLES			
	L	P	H
MOBILI - CABINETS MEUBLES - MUEBLES			
ANTE-DOORS PORTES - PUERTAS			

ARTICOLO ARTICLE	MAGGIORAZIONE PREZZO PRICE INCREASE
 L.45 x p.44,5 x H.81,5	MOBILE BASSO low cabinet  <b>+ € 62,00</b>
 L.45 x p.44,5 x H.158,3	MOBILE MEDIO medium cabinet  <b>+ € 100,00</b>
 L.45 x p.44,5 x H.196,7	MOBILE ALTO high cabinet  <b>+ € 117,00</b>
 L.45 x p.44,5 x H.235	MOBILE ALTO high cabinet  <b>+ € 136,00</b>
 L.45 x p.44,5 x H.260	MOBILE ALTO high cabinet  <b>+ € 148,00</b>

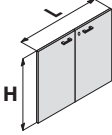
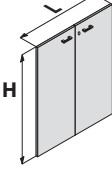
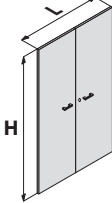
ARTICOLO ARTICLE	MAGGIORAZIONE PREZZO PRICE INCREASE
 L.90 x p.44,5 x H.81,5	MOBILE BASSO low cabinet  <b>+ € 86,00</b>
 L.90 x p.44,5 x H.158,3	MOBILE MEDIO medium cabinet  <b>+ € 137,00</b>
 L.90 x p.44,5 x H.196,7	MOBILE ALTO high cabinet  <b>+ € 168,00</b>
 L.90 x p.44,5 x H.235	MOBILE ALTO high cabinet  <b>+ € 200,00</b>
 L.90 x p.46,3 x H.260	MOBILE ALTO high cabinet  <b>+ € 221,00</b>

ARTICOLO ARTICLE	MAGGIORAZIONE PREZZO PRICE INCREASE
 H.76,4	ANTA BASSA CIECA (H.81,5) low wooden door (h.81,5 cms)  <b>+ € 27,00</b>  H.76,4
 H.114,8	ANTA MEDIA CIECA (H.119,8) medium wooden door (h.119,8 cms)  <b>+ € 33,00</b>  H.114,8
 H.153,2	ANTA MEDIA CIECA (H.158,3) medium wooden door (h.158,3 cms)  <b>+ € 39,00</b>  H.153,2
 H.191,6	ANTA ALTA CIECA (H.196,7) high wooden door (h.196,7 cms)  <b>+ € 53,00</b>  H.191,6
 H.230	ANTA ALTA CIECA (H.235) high wooden door (h.235 cms)  <b>+ € 73,00</b>  H.230
 H.255,6	ANTA ALTA CIECA (H.260) high wooden door (h.260 cms)  <b>+ € 84,00</b>  H.255,6

ARTICOLO ARTICLE	MAGGIORAZIONE PREZZO PRICE INCREASE
 H.76,4	COPPIA ANTE BASSE CIECHE (H.81,5) set of 2 low wooden doors (h.81,5 cms)  <b>+ € 40,00</b>  H.76,4
 H.114,8	COPPIA ANTE MEDIE CIECHE (H.119,8) set of 2 medium wooden doors (h.119,8 cms)  <b>+ € 50,00</b>  H.114,8
 H.153,2	COPPIA ANTE MEDIE CIECHE (H.158,3) set of 2 medium wooden doors (h.158,3 cms)  <b>+ € 60,00</b>  H.153,2
 H.191,6	COPPIA ANTE ALTE CIECHE (H.196,7) set of 2 high wooden doors (h.196,7 cms)  <b>+ € 83,00</b>  H.191,6
 H.230	COPPIA ANTE ALTE CIECHE (H.235) set of 2 high wooden doors (h.235 cms)  <b>+ € 104,00</b>  H.230
 H.255,6	COPPIA ANTE ALTE CIECHE (H.260) set of 2 high wooden doors (h.260 cms)  <b>+ € 117,00</b>  H.255,6



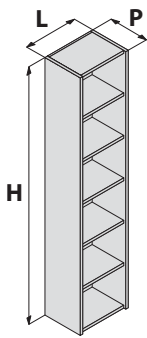
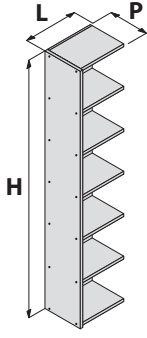
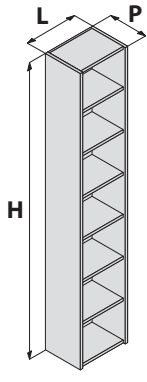
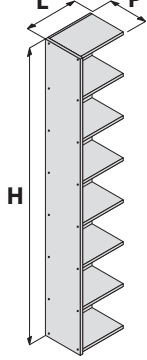

ARTICOLO ARTICLE	MAGGIORAZIONE PREZZO PRICE INCREASE
 <p>L.50 x p.36,9 x H.235</p>	<p>MODULO TERMINALE L.45 terminal module w 45 cms</p> <p><b>+ € 136,00</b></p>
 <p>L.47,5 x p.36,9 x H.235</p>	<p>MODULO CENTRALE L.45 central module w 45 cms</p> <p><b>+ € 120,00</b></p>
 <p>L.50 x p.36,9 x <b>H.270</b></p>	<p>MODULO TERMINALE L.45 terminal module w 45 cms</p> <p><b>+ € 154,00</b></p>
 <p>L.47,5 x p.36,9 x <b>H.270</b></p>	<p>MODULO CENTRALE L.45 central module w 45 cms</p> <p><b>+ € 138,00</b></p>

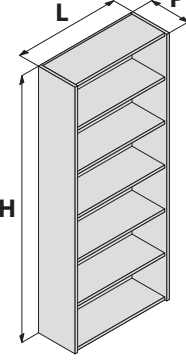
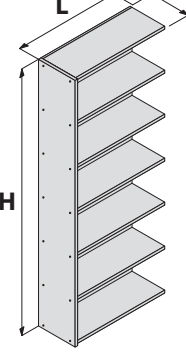
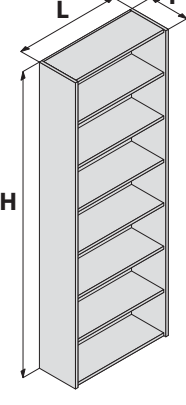
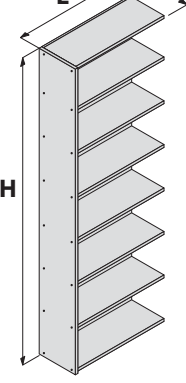
ARTICOLO ARTICLE	MAGGIORAZIONE PREZZO PRICE INCREASE
 <p>L.95 x p.36,9 x H.235</p>	<p>MODULO TERMINALE L.90 terminal module w 90 cms</p> <p><b>+ € 200,00</b></p>
 <p>L.92,5 x p.36,9 x H.235</p>	<p>MODULO CENTRALE L.90 central module w 90 cms</p> <p><b>+ € 184,00</b></p>
 <p>L.95 x p.36,9 x <b>H.270</b></p>	<p>MODULO TERMINALE L.90 terminal module w 90 cms</p> <p><b>+ € 230,00</b></p>
 <p>L.92,5 x p.36,9 x <b>H.270</b></p>	<p>MODULO CENTRALE L.90 central module w 90 cms</p> <p><b>+ € 214,00</b></p>

CONTENITORI  
UNIVERSALI EVO  
universal cabinets EVO





**TIPOLOGIE PER CUI VA SEMPRE RICHIESTO IL PREVENTIVO**  
*PRODUCTS THAT ALWAYS REQUIRE A SPECIAL QUOTATION*

I

- CASSETTIERE, CLASSIFICATORI, KIT CASSETTI
- ANTE CRISTALLO CON O SENZA TELAIO
- PARTI METALLICHE
- TOP DI FINITURA E FIANCHI FINALI
- SCRIVANIE CON PIANI SAGOMATI
- PIANI SAGOMATI
- TERMINALI, RACCORDI E PENISOLE PER SCRIVANIE
- PARTI DI SOSTEGNO IN METALLO (TRAVI, GAMBE METALLICHE, ECC...)
- SCHERMI DIVISORI FRONTALI E LATERALI
- PARETINE

- QUALSIASI MOBILE O SCRIVANIA DI DIMENSIONI ECCEDENTI QUELLE RIPORTATE A LISTINO!  
- CAMBIO COLORE

**RIDUZIONI  
DIMENSIONALI**

**SU  
MISURA**

GB

- PEDESTALS, FILE-CABINETS, KIT DRAWERS
- GLASS DOORS WITH OR WITHOUT FRAME
- METAL ELEMENTS
- FINISH TOP AND FINAL SIDE PANELS
- DESKS WITH SHAPED SURFACE
- SHAPED TOPS
- TERMINALS, JOINING SEGMENTS AND DESK EXTENSIONS
- METAL SUPPORTS (BEAMS, METAL LEGS, ECC...)
- FRONT OR LATERAL DIVIDING SCREENS
- PARTITION PANELS

- ALL CABINETS OR DESKS WITH DIMENSIONS EXCEEDING THOSE PROPOSED IN THE PRICE LIST!  
- COLOR CHANGE

**SIZES  
REDUCTION**

**CUSTOMIZED**

## DESCRIZIONE TECNICA

### CASSETTIERE, PORTACOPY E MOBILE DI SERVIZIO:

Struttura realizzata con pannello di particelle legno sp. mm 18 nobilitato in melaminico, disponibile nei colori: ARGENTO GOLF 01, NOCE PAVIA 06, STONE GREY 44, ANTRACITE 55, BIANCO BR. 69, rifinita perimetralmente con bordo melaminico mm 0,4. I frontali sono realizzati con pannello di particelle di legno sp. mm 18 nobilitato melaminico e disponibili nei colori: ARGENTO GOLF 01, ROVERE 03, ROVERE GREY 04, NOCE PAVIA 06, GIALLO FRESIA 11, AZZURRO SKY 32, AMARANTO 33, GRIGIO 42, STONE GREY 44, WENGE' 45, ANTRACITE 55, ACERO TAKI 58, BIANCO BR. 69, VERDE BOSCO 96 bordati perimetralmente in ABS mm 2 in tinta con la superficie. I cassetti in legno sono dotati di serratura centralizzata, le spondine sono in fibre legnose sp. mm 12 rivestite in PVC nero, il fondo è in fibra dello spessore di mm 3. Le guide scorrevoli sono del tipo in metallo con cuscinetti in nylon dotati di fine corsa in estrazione e self-closing in chiusura. Sono dotate di ruote piroettanti in nylon grigio.

Le cassette su ruote sono anche disponibili nella versione mono-colore: GIALLO FRESIA 11, AZZURRO SKY 32, AMARANTO 33, VERDE BOSCO 96.

### CUSCINI PER CASSETTIERE E MOBILI DI SERVIZIO:

Supporto rigido in masonite sp. mm 4, imbottitura in gomma espansa indeformabile sp. mm 30, densità 40 Kg./m<sup>3</sup>.

Retro rivestito in trapunta nera. Fissaggio al top di cassettiere o mobile di servizio tramite velcro biadesivo.

Tappezzeria cucita perimetralmente e disponibile di serie in 2 tipologie di tessuto:

CAT. A - Tessuto polipropilene ignifugo (11 colori)

CAT. F - Poliestere stretch ignifugo (13 colori)

(Altri tessuti della cartella Forsit fornibili a richiesta come fuori serie in quantità e modalità da concordare)

### MOBILI CONTENITORI BASSI, MEDI E ALTI:

**Struttura** costituita da: base, cappello, due fianchi, schiena (da sp. mm 18 inserita in fresata) e ripiani.

E' realizzata con pannelli di particelle legno sp. mm 18 nobilitati in melaminico, disponibili nei colori: ARGENTO GOLF 01, NOCE PAVIA 06, STONE GREY 44, ANTRACITE 55, BIANCO BR. 69, rifiniti perimetralmente con bordo melaminico mm 0,4. Sulla base sono inseriti piedini regolabili in altezza, in nylon nero (4 su mobili L.45, 5 su mobili L.90), con campo di regolazione di mm 15.

**I cassetti** in legno sono dotati di spondine sono in fibre legnose spessore mm 12 rivestite in PVC nero, il fondo è in fibra dello spessore di mm. 3. Le guide scorrevoli sono del tipo in metallo con cuscinetti in nylon dotati di fine corsa in estrazione e self-closing in chiusura.

**Ripiani** realizzati con pannelli di particelle legno sp. mm 25 nobilitato in melaminico, disponibile nei colori: ARGENTO GOLF 01, NOCE PAVIA 06, STONE GREY 44, ANTRACITE 55, BIANCO BR. 69, rifiniti perimetralmente con bordo melaminico sp. mm 0,4 in tinta con la superficie. Sono dotati di ferramenta a scomparsa, posizionabili in altezza con passo di 32mm.

(A richiesta sono disponibili ripiani registrabili in lamiera di acciaio)

**I frontali e le ante** sono realizzati con pannello di particelle di legno sp. mm 18 nobilitato melaminico e disponibili nei colori: ARGENTO GOLF 01, ROVERE 03, ROVERE GREY 04, NOCE PAVIA 06, GIALLO FRESIA 11, AZZURRO SKY 32, AMARANTO 33, GRIGIO 42, STONE GREY 44, WENGE' 45, ANTRACITE 55, ACERO TAKI 58, BIANCO BR. 69, VERDE BOSCO 96. I bordi perimetrali sono in ABS mm 2 in tinta con la superficie. Le cerniere sono del tipo ad ala metallica con apertura a 110°, complete di basi, con regolazione 3D.

Le cerniere delle ante legno possono essere accessoriate con kit ammortizzatori, forniti a parte, per una chiusura soft-close.

Le ante vetro sono disponibili in 2 tipologie:

- con telaio, con vetro temperato satinato sp. mm 4, con serratura e maniglia a "ponte" colore ARGENTO;
- senza telaio, con vetro temperato trasparente sp. mm 5, con o senza serratura, maniglia a pomo colore ARGENTO.

Le ante legno basse e medie sono dotate di serratura a paletto, le ante alte sono dotate di serratura ad aste rotanti con 2 punti di chiusura.

Tutte le ante con serratura hanno il cilindro estraibile e sono fornite con doppia chiave pieghevole anti-infortunistica.

Per i mobili bassi e medi è consigliato l'uso di top di finitura riportato.

I contenitori Universali Evo sono conformi secondo: UNI EN 14073-2, UNI EN 14073-3, UNI EN 14074, UNI 8601, UNI 8606

### LIBRERIE SPALLA UNICA

Disponibile in due moduli, L.45 e L.90 interni ai fianchi con altezza cm.235 e 270.

Struttura costituita da: base, cappello, due fianchi, schiena e ripiani. Nel caso di modulo centrale un solo fianco per dare possibilità di aggregare in linea.

E' realizzata con pannelli di particelle legno sp. mm 25 nobilitati in melaminico, disponibili nei colori: ARGENTO GOLF 01, NOCE PAVIA 06, STONE GREY 44, ANTRACITE 55, BIANCO BR. 69. I fianchi sono rifiniti perimetralmente con bordo in abs di spessore mm.2, il resto della struttura con bordo melaminico di spessore mm.0.4 in tinta con la superficie. Sulla base vengono inseriti piedini metallici regolabili in altezza dall'interno del mobile.

Schiena realizzata con pannelli di particelle legno sp. mm 18 nobilitato in melaminico, disponibile nei colori: ARGENTO GOLF 01, NOCE PAVIA 06, STONE GREY 44, ANTRACITE 55, BIANCO BR. 69, rifiniti perimetralmente con bordo melaminico sp. mm 0,4 in tinta con la superficie.

Ante sono realizzate con pannelli di particelle di legno sp. mm 18 nobilitati melaminico e disponibili nei colori: ARGENTO GOLF 01, ROVERE 03, ROVERE GREY 04, NOCE PAVIA 06, GIALLO FRESIA 11, AZZURRO SKY 32, AMARANTO 33, GRIGIO 42, STONE GREY 44, WENGE' 45, ANTRACITE 55, ACERO TAKI 58, BIANCO BR. 69, VERDE BOSCO 96. I bordi perimetrali sono in ABS mm 2 in tinta con la superficie. Le cerniere sono del tipo ad ala metallica con apertura a 110°, complete di basi, con regolazione 3D che permettono il posizionamento delle ante a luce fra i due fianchi. La loro sovrapposibilità permette di coprire totalmente le altezze della libreria.

Le cerniere delle ante legno possono essere accessoriate con kit ammortizzatori, forniti a parte, per una chiusura soft-close.

Le ante vetro sono realizzate con telaio perimetrale in alluminio e vetro temperato satinato sp. mm 4, con serratura e maniglia a "ponte" colore ARGENTO;

Le ante sono dotate di serratura a paletto con cilindro estraibile fornite con doppia chiave pieghevole anti-infortunistica.

### MANIGLIA:

Con sagoma a "ponte", interasse mm 64 realizzata in polipropilene, fornita in tinta unita in abbinamento al colore delle ante e frontali.

Sono disponibili anche kit da 6 pezzi nei colori a tinta unita: ARGENTO, NOCE PAVIA, WENGE', BIANCO, ANTRACITE, ROVERE GREY, ROVERE (ACERO TAKI), STONE GREY, GIALLO FRESIA, AZZURRO SKY, AMARANTO, VERDE BOSCO.

### SERRANDINA PER MOBILI:

Disponibile sulle strutture dei mobili di serie L.90 X h 158,3 e h 196,7 .

Il kit è costituito da 1 coppia di guide da sovrapporre ai fianchi, da 1 telo serrandina e da meccanismo a rullo per guida e frenata della serrandina in apertura e chiusura. Le guide ed il telo serrandina sono realizzati in pvc colore ARGENTO.

Le serrandine sono disponibili con serratura.

### TOP DI FINITURA:

Realizzato con pannello di particelle legno sp. mm 18 nobilitato in melaminico, disponibile nei colori : ARGENTO GOLF 01, ROVERE 03, ROVERE GREY 04, NOCE PAVIA 06, GRIGIO 42, STONE GREY 44, WENGE' 45, ANTRACITE 55, ACERO TAKI 58, BIANCO BR. 69, rifinito perimetralmente con bordo ABS mm 2 in tinta con la superficie.

### STRUTTURA METALLICA PER MOBILI FREESTANDING

Realizzata in tubolare metallico a sezione rettangolare mm40x15x1,5, verniciata a polveri epossidiche nei colori: ARGENTO, BIANCO, ANTRACITE, STONE GREY. Sulla base sono inseriti piedini livellatori in nylon neri.

### MOBILI CON ANTE SCORREVOLI (ART.986-987):

Sono composti da: una base, due fianchi esterni, due schiene, un cappello, due ante scorrevoli, un fianco centrale e ripiani registrabili.

Cappello, base, fianchi esterni, fianco centrale e ripiani registrabili:

Realizzati con pannelli di particelle di legno sp. mm 25 nobilitati in melaminico rifinito con bordo ABS mm 2 in tinta con la superficie applicato con colle termofusibili.

Sono disponibili nei colori: ARGENTO GOLF 01, NOCE PAVIA 06, STONE GREY 44, ANTRACITE 55, BIANCO BR. 69.

Schiene:

Realizzate con pannelli di particelle di legno sp. mm 18 nobilitati in melaminico rifiniti perimetralmente con con bordo melaminico sp. mm 0,4 in tinta con la superficie applicato con colle termofusibili.

Sono disponibili nei colori: ARGENTO GOLF 01, NOCE PAVIA 06, STONE GREY 44, ANTRACITE 55, BIANCO BR. 69

Ante scorrevoli:

Sono realizzate con pannelli di particelle di legno sp. mm 18 nobilitati in melaminico rifiniti perimetralmente con bordo ABS sp. mm 2 applicato con colle termofusibili.

Sono disponibili nei colori: ARGENTO GOLF 01, ROVERE 03, ROVERE GREY 04, NOCE PAVIA 06, GRIGIO 42, STONE GREY 44, WENGE' 45, ANTRACITE 55, ACERO TAKI 58, BIANCO BR. 69.

Sono dotate di serratura.

L'anta anteriore è provvista di due profili "maniglia" di colore ARGENTO.

L'anta posteriore è provvista, invece, di un profilo maniglia e di un profilo finitura, di colore ARGENTO.

Ogni anta è provvista, sul lato superiore, di due guide a molla con fermo di tenuta colore nero e, sul lato inferiore, di due scorrevoli con rotelle in nylon Ø 30.

Le due ante scorrono, superiormente, su un binario in materiale plastico bianco applicato al cappello e, inferiormente, su un binario in alluminio anodizzato argento, applicato alla base.

### IMBALLO

Tutti i componenti sono forniti smontati ed imballati con involucro pieghevole in cartone triplo, listelli di protezione perimetrale e per i riempimenti ove occorre. Gli angoli sono protetti, ove occorre, con parasigoli anti-urto. La chiusura dell'imballo avviene mediante nastro adesivo e reggetta in nylon termosaldato.

Le cassettiere sono fornite montate, protette sui lati con angolari in polistirolo ed imballate con foglia di polietilene termoretraibile.

CARATTERISTICHE FISICO-MECCANICHE DEI PANNELLI DI PARTICELLE DI LEGNO DI SPESSORE mm 18 NOBILITATI IN MELAMINICO:		
DESCRIZIONE	VALORE MINIMO	NORMA DI RIFERIMENTO
Massa volumica	650 Kg / m <sup>3</sup> ± 10%	UNI EN 323 :1994
Umidità relativa	5 - 13%	UNI EN 322 :1994
Tolleranza spessore	± 0,3 mm	UNI EN 324-1/1994
Rigonfiamento a 24 ore	15%	UNI EN 317 :1994
Distacco strati esterni	0,8 Mpa	UNI EN 311 :2003
Flessione statica	16 Mpa	UNI EN 310 :1994
Modulo di elasticità	1600 Mpa	UNI EN 310 :1994
Estrazione viti sui bordi	> 400 N	UNI EN 320 :1994
Contenuto di formaldeide	≤ a 3,5 mg H <sub>2</sub> CO (m <sup>2</sup> x h)	UNI EN ISO 12460 - 3:2015

Emesso da Ufficio Tecnico

LAS MOBILI

Data ultima revisione:

GENNAIO 2018

## TECHNICAL DESCRIPTION

### DRAWER UNITS:

Structure made of 18 mm thick particleboards faced with melamine, available in colours: GOLF SILVER 01, PAVIA WALNUT 06, STONE GREY 44, ANTHRACITE 55, BR. WHITE 69, with 0.4 mm melamine edge. The fronts are made of 18 mm thick particleboards faced with melamine and are available in colours: GOLF SILVER 01, OAK 03, GREY OAK 04, PAVIA WALNUT 06, FREESIA YELLOW 11, SKY BLUE 32, AMARANTH 33, GREY 42, STONE GREY 44, WENGE' 45, ANTHRACITE 55, TAKI MAPLE 58, BR. WHITE 69, WOOD GREEN 96 with 2 mm ABS edge to match the surface.

The wood drawers feature a centralised lock, the sides are made from 12 mm thick wood fibre covered with black PVC. The bottom is made from 3 mm thick wood fibre. The runners are made of metal with nylon bearings complete with mechanical extraction stops and self-closing mechanism. The drawer units have grey nylon castors.

The pedestal on wheels are available in single-colour version also: FREESIA YELLOW 11, SKY BLUE 32, AMARANTH 33, WOOD GREEN 96.

### CUSHIONS FOR PEDESTALS AND SERVICE UNITS:

Structure made of 4 mm thick panel, with undeformable rubber padding of 30 mm thick and density 40 kg / m<sup>3</sup>.

The bottom is covered with black quilt.

Fixing to the top of pedestals or service units using double-sided adhesive Velcro.

Upholstery available in 2 types of fabrics:

CAT. A - Fire-retardant polypropylene fabric (11 colours)

CAT. F - Fire-Retardant Stretch Polyester (13 colours)

Other fabrics of the Forsit colour chart are available as special on request in quantity and modality to be agreed.

### LOW, MEDIUM AND HIGH CABINETS:

**Structure** consists of: base, upper panel, two side panels and back (of 18mm thick inserted into milled).

Structure made of 18 mm thick particleboards faced with melamine, available in colours : GOLF SILVER 01, PAVIA WALNUT 06, STONE GREY 44, ANTHRACITE 55, BR. WHITE 69, edge in 0.4 mm melamine. Height-adjustable feet in black nylon fixed under the base (4 for cabinets w 45 cms, 5 for cabinets w 90 cms), with adjustment range of 15 mm.

**The shelves** are made of 25 mm thick particleboards faced with melamine, available in colours : GOLF SILVER 01, PAVIA WALNUT 06, STONE GREY 44, ANTHRACITE 55, BR. WHITE 69. The edge surround is made of 0,4 mm melamine to match the surface.

They are equipped with concealed hardware and can be fixed at height pitch of 32mm.

(Adjustable sheet steel shelves available on request)

**The wooden drawers** are equipped with edges are in 12 mm fibreboards covered in black PVC, the bottom is in 3 mm fibre.

The sliding guides are in metal with nylon cushions equipped with end run extraction and self-closing closure.

**The fronts and doors** are made from 18 mm thick particleboards faced with melamine and available in colours: GOLF SILVER 01, OAK 03, GREY OAK 04, PAVIA WALNUT 06, FREESIA YELLOW 11, SKY BLUE 32, AMARANTH 33, GREY 42, STONE GREY 44, WENGE' 45, ANTHRACITE 55, TAKI MAPLE 58, BR. WHITE 69, WOOD GREEN 96. The edge is made of 2 mm ABS to match the surface. The hinges have a metal arm with 110° opening, complete with bases, with 3D adjustment.

The hinges of wooden doors can be equipped with dampers kit, supplied separately, for a soft-close.

The glass doors are without frame with tempered transparent glass, with lock or without lock.

The glass doors are available in 2 types:

- with frame, with 4 mm thick tempered satined glass, with lock, are equipped of "bridge" handle in colour SILVER.

- without frame, with 5 mm thick tempered transparent glass, with or without lock, are equipped of knobs in colour SILVER.

The low and medium sized wooden doors are fitted with a bolt lock, the high doors are fitted with rotating rod lock with 2 closing points.

All doors with locks have removable cylinder and are equipped with double folding key (accident prevention).

**For low and medium cabinets the use of finishing top is recommended.**

The cabinets comply with the following norms: UNI EN 14073-2, EN 14073-3, UNI EN 14074, UNI 8601, UNI 8606

### HIGH BOOKCASES WITH SHARED SIDE PANEL

Available in two modules, width 45 cms and width 90 cms inside the sides, with height cm.235 and 270.

Structure consists of: base, top, two sides, back and shelves. In the case of a central module, only one shared side panel for aggregation in line.

Structure made of 25 mm thick particleboards faced with melamine, available in colours : GOLF SILVER 01, PAVIA WALNUT 06, STONE GREY 44, ANTHRACITE 55, BR. WHITE 69.

The side panels are perimetrically finished with 2 mm ABS, the rest of the structure with melamine edge 0,4 mm thick. to match the surface.

On the base are inserted metal feet , adjustable from inside the cabinet.

The back panel is made of 18 mm thick particleboards faced with melamine, available in colours : GOLF SILVER 01, PAVIA WALNUT 06, STONE GREY 44, ANTHRACITE 55, BR. WHITE 69, edge in 0.4 mm melamine.

**The wooden doors** are made from 18 mm thick particleboards faced with melamine and available in colours: GOLF SILVER 01, OAK 03, GREY OAK 04, PAVIA WALNUT 06, FREESIA YELLOW 11, SKY BLUE 32, AMARANTH 33, GREY 42, STONE GREY 44, WENGE' 45, ANTHRACITE 55, TAKI MAPLE 58, BR. WHITE 69, WOOD GREEN 96. The edge is made of 2 mm ABS to match the surface. The hinges have a metal arm with 110° opening, complete with bases, with 3D adjustment. Their superimposition allows to completely cover the heights of the library.

The hinges of wooden doors can be equipped with dampers kit, supplied separately, for a soft-close.

The glass doors are available with frame, with 4 mm thick tempered satined glass, with lock, are equipped of "bridge" handle in colour SILVER.

The doors are fitted with a bolt lock, have removable cylinder and are equipped with double folding key (accident prevention).

### HANDLE:

"Bridge" shaped design, made of polypropylene, supplied to match the color of the doors and fronts.

They are available, sold separately, in kit of 6 pieces in solid colours: SILVER, PAVIA WALNUT, WENGE' WHITE, ANTHRACITE, GREY OAK, OAK (TAKI MAPLE), STONE GREY, FREESIA YELLOW, SKY BLUE, AMARANTH, WOOD GREEN.

### ROLLING-SHUTTER FOR MEDIUM AND HIGH CABINETS:

Supplied with medium and high cabinets width 90 x h 158,3 and h 196,7 cms.

The kit consists of 1 pair of runners to be fitted to the side panels, of 1 shutter and a roller mechanism for guiding and braking the shutter when opening or closing. The runners and the shutter are made of PVC colour SILVER. They are available with lock.

**FINISHING TOP:**

Made of 18 mm thick particleboards faced with melamine, available in colours : GOLF SILVER 01, OAK 03, GREY OAK 04, PAVIA WALNUT 06, GREY 42, STONE GREY 44, WENGE' 45, ANTHRACITE 55, TAKI MAPLE 58, BR. WHITE 69. The edge is made of 2 mm ABS to match the surface.

**METALLIC STRUCTURE FOR FREESTANDING CABINETS**

Structure made from metallic tubular with rectangular section mm40x15x1,5 thick., painted with epoxy resin powder in colours: SILVER, WHITE, ANTHRACITE, STONE GREY. The metallic structure is equipped with levelling feet in printed nylon.

**CABINET WITH SLIDING DOORS (ART.986-987):**

Composed of a base, two external side panels, two back panels, one top panel, two sliding doors, a central side panel and adjustable shelves. Top panel, base, external side panels, central side panel and adjustable shelves:

Made of 25 mm thick particleboards, melamine coated, finished with a 2 mm ABS edge of the same colour of the surface, applied with hot glue.

Available in these colours: GOLF SILVER 01, PAVIA WALNUT 06, STONE GREY 44, ANTHRACITE 55, BR. WHITE 69.

Back panels:

Made of 18 mm thick particleboards , melamine coated, finished in their perimeter with a melamine edge of 0.4 mm thickness the same colour of the surface, applied with hot glue.

Available in these colours: GOLF SILVER 01, PAVIA WALNUT 06, STONE GREY 44, ANTHRACITE 55, BR. WHITE 69.

Sliding doors:

Made of 18 mm thick particleboards , melamine coated, finished in their perimeter with a 2 mm ABS edge applied with hot glue.

Available in these colours: GOLF SILVER 01, OAK 03, GREY OAK 04, PAVIA WALNUT 06, GREY 42, STONE GREY 44, WENGE' 45, ANTHRACITE 55, TAKI MAPLE 58, BR. WHITE 69 . Lock included.

The front door has two "handle" profiles coloured SILVER.

The back door has a handle profile and a finishing profile, coloured SILVER.

On the upper side of each door there are two spring guides with a black latch. The lower side has two slides with Ø 30 nylon castors.

The two doors slide along a white plastic track fixed to the top panel and a silver-coloured anodized aluminium track fixed to the base.

The vertical sides include a silver aluminium oxide handle.

The glass doors are made with a silver aluminium oxide frame with satin etched toughened glass.

**PACKAGING**

All the components are disassembled and packed when supplied, and have paper triple type folding packaging, fillets for the perimetrical protection and for the fillings up, where needed . The corners are protected, where needed, through shock resistant edges protector. The packing closure occurs through sticky tape and welded nylon strap.

Pedestals are assembled, when supplied, protected through polystyrene angle bars on the sides and packed using thermo-retractable polyethylene leave when provided.

PHYSICAL-MECHANICAL CHARACTERISTICS OF 18 MM THICK PARTICLEBOARD PANELS, MELAMINE-FACED:		
DESCRIPTION	MINIMUM VALUE	STANDARD NUMBERS
Volume Mass	650 Kg / m <sup>3</sup> ± 10%	UNI EN 323 :1994
Relative Humidity	5 - 13%	UNI EN 322 :1994
Thickness Allowance	± 0,3 mm	UNI EN 324-1/1994
24 hour Swelling	15%	UNI EN 317 :1994
External Surfaces Detachment	0,8 Mpa	UNI EN 311 :2003
Static Flexure	16 Mpa	UNI EN 310 :1994
Elastic Modulus	1600 Mpa	UNI EN 310 :1994
Edge Screws Extraction	> 400 N	UNI EN 320 :1994
Formaldehyde Content	≤ a 3,5 mg H2CO (m <sup>2</sup> x h)	UNI EN ISO 12460 - 3:2015

Released by the Technical Office  
of LAS MOBILI  
last revision date:  
JANUARY 2018

# INDICE DEI CODICI

## codes index

\* = INDICARE IL CODICE FINITURA  
= complete with finish code

INDICE DEI CODICI codes index  
Mod. CONTENITORI UNIV. EVO  
Mod. Universal Cabinets EVO

CODICE code	DESCRIZIONE description	PAG. page	PREZZO price
114 188 *	MOBILE DI SERVIZIO L.67,7 SU RUOTE CON SERRATURA service unit w 67.7 cms on wheels with lock	11	€ 215,00
114 189 *	MOBILE DI SERVIZIO L.67,7 SU RUOTE CON SERRATURA (CHIUSURA AMMORTIZZATA) service unit w 67.7 cms on wheels with lock (with soft-close)	11	€ 232,00
114 207 *	RIPIANO REGISTRABILE L.45 adjustable shelf w 45 cms	31	€ 14,00
114 208 *	RIPIANO REGISTRABILE L.90 adjustable shelf w 90 cms	31	€ 22,00
114 209 *	RIPIANO REGISTRABILE L.45 adjustable shelf w 45 cms	31	€ 12,00
114 210 *	RIPIANO REGISTRABILE L.90 adjustable shelf w 90 cms	31	€ 18,00
114 301 *	CASSETTIERA SU RUOTE 3 CASSETTI ( IN LEGNO ) +SERR. (CHIUSURA AMMORTIZZATA) Pedestal on wheels 3 ( wooden ) drawers with lock (with soft-close)	8	€ 169,00
114 302 *	CASSETTIERA- CLASSIFICATORE ( IN LEGNO ) SU RUOTE +SERR. (CHIUSURA AMMORTIZZATA) Pedestal on wheels ( wooden ) file-drawer with lock (with soft-close)	8	€ 171,00
114 304 *	CASSETTIERA SU RUOTE 3 CASSETTI ( IN LEGNO ) CON SERRATURA + 1 PORTA-CANCELLERIA (CHIUSURA AMMORTIZZATA) Pedestal on wheels 3 ( wooden ) drawers with lock + 1 stationery-drawer	8	€ 217,00
114 306 *	CASSETTIERA- CLASSIFICATORE ( IN LEGNO ) SU RUOTE CON SERRATURA + 1 PORTA-CANCELLERIA (CHIUSURA AMMORTIZZATA) Pedestal on wheels ( wooden ) file-drawer with lock + 1 stationery-drawer (with soft-close)	8	€ 187,00
114 321 *	CASSETTIERA SU RUOTE 3 CASSETTI ( IN METALLO ) +SERR. (CHIUSURA AMMORTIZZATA) Pedestal on wheels 3 ( metal ) drawers with lock	8	€ 306,00
114 322 *	CASSETTIERA SU RUOTE 3 CASSETTI ( IN METALLO ) CON SERRATURA + 1 PORTA-CANCELLERIA (CHIUSURA AMMORTIZZATA) Pedestal on wheels 3 ( metal ) drawers with lock + 1 stationery-drawer (with soft-close)	8	€ 354,00
114 323 *	CASSETTIERA- CLASSIFICATORE ( IN METALLO ) SU RUOTE CON SERRATURA + 1 PORTA-CANCELLERIA (CHIUSURA AMMORTIZZATA) Pedestal on wheels ( metal ) file-drawer with lock + 1 stationery-drawer (with soft-close)	8	€ 270,00
114 324 *	CASSETTIERA- CLASSIFICATORE ( IN METALLO ) SU RUOTE +SERR. (CHIUSURA AMMORTIZZATA) Pedestal on wheels ( metal ) file-drawer with lock (with soft-close)	8	€ 289,00
114 354 *	KIT 1 AMMORTIZZATORE PER ANTE LEGNO kit 1 damper for soft-close wooden doors	38	€ 8,00
114 355 *	KIT 2 AMMORTIZZATORI PER ANTE LEGNO kit 2 dampers for soft-close wooden doors	38	€ 12,00
114 356 *	KIT 3 AMMORTIZZATORI PER ANTE LEGNO kit 3 dampers for soft-close wooden doors	38	€ 16,00
114 358 *	KIT 6 MANIGLIE (MOD. 5TH ELEMENT) set of 6 handles (MOD. 5TH ELEMENT)	39	€ 38,00
114 360 *	KIT 6 MANIGLIE CROMATE set of 6 chromed handles	39	€ 13,00
114 361 *	KIT 6 MANIGLIE (CONTENITORI UNIVERSALI EVO) set of 6 white handles (universal cabinets evo)	39	€ 11,00
114 364 *	KIT 4 BASETTE CON CERNIERE 175° set of 4 plates with 175° opening hinges	38	€ 29,00
114 365 *	KIT 6 BASETTE CON CERNIERE 175° set of 6 plates with 175° opening hinges	38	€ 43,00
114 401 *	CASSETTIERA SU RUOTE 3 CASSETTI ( IN LEGNO ) +SERR. Pedestal on wheels 3 ( wooden ) drawers with lock	8	€ 152,00
114 402 *	CASSETTIERA- CLASSIFICATORE ( IN LEGNO ) SU RUOTE +SERR. Pedestal on wheels ( wooden ) file-drawer with lock	8	€ 160,00
114 404 *	CASSETTIERA SU RUOTE 3 CASSETTI ( IN LEGNO ) CON SERRATURA + 1 PORTA-CANCELLERIA Pedestal on wheels 3 ( wooden ) drawers with lock + 1 stationery-drawer	8	€ 197,00
114 406 *	CASSETTIERA- CLASSIFICATORE ( IN LEGNO ) SU RUOTE CON SERRATURA + 1 PORTA-CANCELLERIA Pedestal on wheels ( wooden ) file-drawer with lock + 1 stationery-drawer	8	€ 177,00
114 409 *	MOBILE PORTA-FOTOCOPIATORE SU RUOTE photocopier-stand on wheels	11	€ 148,00
114 410 *	MOBILE PORTA-FOTOCOPIATORE SU RUOTE photocopier-stand on wheels	11	€ 141,00
114 550 *	ANTA BASSA DX + SERR. right low wooden door + lock	33	€ 31,00
114 551 *	ANTA BASSA SX + SERR. left low wooden door + lock	33	€ 31,00
114 552 *	ANTA BASSA DX o SX right or left low wooden door	33	€ 25,00
114 554 *	COPPIA ANTE BASSE + SERR. Set of 2 low wooden doors + lock	33	€ 52,00
114 555 *	COPPIA ANTE BASSE Set of 2 low wooden doors	33	€ 46,00
114 556 *	ANTA MEDIA SUPERIORE DX + SERRATURA right upper medium wooden door + lock	35	€ 38,00
114 557 *	ANTA MEDIA SUPERIORE SX + SERRATURA left upper medium wooden door + lock	35	€ 38,00
114 558 *	ANTA MEDIA SUPERIORE DX o SX right or left upper medium wooden door	35	€ 31,00
114 559 *	COPPIA ANTE MEDIE H.119,8 + SERR. set of 2 medium wooden doors H.119,8 + lock	35	€ 66,00
114 560 *	COPPIA ANTE MEDIE SUPERIORI + SERRATURA set of 2 upper medium wooden doors + lock	35	€ 66,00
114 561 *	COPPIA ANTE MEDIE SUPERIORI set of 2 upper medium wooden doors	35	€ 60,00
114 562 *	ANTA MEDIA DX H.158,3 + SERR. medium right wooden door H.158,3 + lock	34	€ 53,00
114 563 *	ANTA MEDIA SX H.158,3 + SERR. medium left wooden door h. 150 + lock	34	€ 53,00
114 564 *	ANTA MEDIA DX o SX H.158,3 right or left medium wooden door H.158,3	34	€ 47,00
114 566 *	COPPIA ANTE MEDIE H.158,3 + SERR. set of 2 medium wooden doors H.158,3 + lock	34	€ 85,00
114 567 *	COPPIA ANTE MEDIE H.158,3 set of 2 medium wooden doors H.158,3	34	€ 79,00
114 568 *	ANTA ALTA DX + SERR. right high wooden door + lock	H.196,7	€ 79,00
114 569 *	ANTA ALTA SX + SERR. left high wooden door + lock	H.196,7	€ 79,00
114 570 *	COPPIA ANTE ALTE + SERR. Set of 2 high wooden doors + lock	H.196,7	€ 125,00
114 571 *	ANTA MEDIA SUPERIORE DX + SERRATURA right upper medium wooden door + lock	H.235	€ 53,00
114 572 *	ANTA MEDIA SUPERIORE SX + SERRATURA left upper medium wooden door + lock	H.235	€ 53,00
114 573 *	ANTA MEDIA SUPERIORE DX o SX right or left upper medium wooden door	H.235	€ 47,00
114 574 *	COPPIA ANTE MEDIE SUPERIORI + SERRATURA set of 2 upper medium wooden doors + lock	H.235	€ 85,00

CONTENITORI  
UNIVERSALI EVO  
universal cabinets evo

\* = INDICARE IL CODICE FINITURA  
= complete with finish code

INDICE DEI CODICI codes index  
Mod. CONTENITORI UNIV. EVO  
Mod. Universal Cabinets EVO

CODICE code	DESCRIZIONE description	PAG. page	PREZZO price
114 575 *	COPPIA ANTE MEDIE SUPERIORI set of 2 upper medium wooden doors H.235	36	€ 79,00
114 576 *	ANTA ALTA DX + SERR. right high wooden door + lock H.235	37	€ 90,00
114 577 *	ANTA ALTA SX + SERR. left high wooden door + lock H.235	37	€ 90,00
114 578 *	COPPIA ANTE ALTE + SERR. Set of 2 high wooden doors + lock H.235	37	€ 145,00
114 579 *	ANTA ALTA DX + SERR. right high wooden door + lock H.260	37	€ 96,00
114 580 *	ANTA ALTA SX + SERR. left high wooden door + lock H.260	37	€ 96,00
114 581 *	COPPIA ANTE ALTE + SERR. Set of 2 high wooden doors + lock H.260	37	€ 157,00
114 586 *	ANTA BASSA DX O SX SENZA SERRATURA (REVERSIBILE) right or left low wooden door without lock (reversible)	32	€ 18,00
114 587 *	1 RIPIANO FISSO SUPPLEMENTARE L.45 1 additional fixed shelf w 45 cms PROF. CM 46,6 depth 46,6 cms	31	€ 14,00
114 588 *	1 RIPIANO FISSO SUPPLEMENTARE L.90 1 additional fixed shelf w 90 cms PROF. CM 46,6 depth 46,6 cms	31	€ 22,00
114 589 *	1 RIPIANO FISSO SUPPLEMENTARE L.45 1 additional fixed shelf w 45 cms PROF. CM 35 depth 35 cms	31	€ 12,00
114 590 *	1 RIPIANO FISSO SUPPLEMENTARE L.90 1 additional fixed shelf w 90 cms PROF. CM 35 depth 35 cms	31	€ 18,00
114 597 *	MOBILE BASSO L.45 CON 4 CASSETTI SENZA SERRATURA (CHIUSURA AMMORTIZZATA) low cabinet w 45 cms with 4 drawers without lock (with soft-close) H.81,5	11	€ 188,00
114 638 *	2 CASSETTI CLASSIFICATORI PER MOBILI L.45 + SERR. Set of 2 file-drawers for cabinets w 45 cms + lock	31	€ 172,00
114 639 *	2 CASSETTI CLASSIFICATORI PER MOBILI L.90 + SERR. Set of 2 file-drawers for cabinets w 90 cms + lock	31	€ 216,00
114 660 *	TOP L.45 top w 45 cms PROF. CM 46,9 depth 46,9 cms	30	€ 14,00
114 662 *	TOP L.90 top w 90 cms PROF. CM 46,9 depth 46,9 cms	30	€ 22,00
114 663 *	TOP L.135,2 top w 135,2 cms PROF. CM 46,9 depth 46,9 cms	30	€ 32,00
114 664 *	TOP L.180,2 top w 180,2 cms PROF. CM 46,9 depth 46,9 cms	30	€ 42,00
114 665 *	TOP L.225,1 top w 225,1 cms PROF. CM 46,9 depth 46,9 cms	30	€ 49,00
114 666 *	TOP L.270,1 top w 270,1 cms PROF. CM 46,9 depth 46,9 cms	30	€ 58,00
114 670 *	TOP L.45 top w 45 cms PROF. CM 37 depth 37 cms	30	€ 12,00
114 672 *	TOP L.90 top w 90 cms PROF. CM 37 depth 37 cms	30	€ 19,00
114 673 *	TOP L.135,2 top w 135,2 cms PROF. CM 37 depth 37 cms	30	€ 26,00
114 674 *	TOP L.180,2 top w 180,2 cms PROF. CM 37 depth 37 cms	30	€ 34,00
114 675 *	TOP L.225,1 top w 225,1 cms PROF. CM 37 depth 37 cms	30	€ 43,00
114 676 *	TOP L.270,1 top w 270,1 cms PROF. CM 37 depth 37 cms	30	€ 50,00
114 689 *	ANTA VETRO SUPERIORE DX o SX PER MOBILI ALTI + SERR. right or left upper medium glass door for high cabinets + lock (VETRO TEMPERATO TRASPARENTE SENZA TELAIO) (tempered transparent glass without frame)	41	€ 76,00
114 690 *	ANTA VETRO MEDIA DX o SX PER MOBILI H.158,3 right or left medium glass door for cabinet H.158,3 cms (VETRO TEMPERATO TRASPARENTE SENZA TELAIO) (tempered transparent glass without frame)	41	€ 83,00
114 691 *	ANTA VETRO MEDIA DX o SX PER MOBILI H.158,3 + SERR. right or left medium glass door for cabinet H.158,3 cms + lock (VETRO TEMPERATO TRASPARENTE SENZA TELAIO) (tempered transparent glass without frame)	41	€ 95,00
114 692 *	ANTA VETRO SUPERIORE DX o SX PER MOBILI ALTI right or left upper medium glass door for high cabinets (VETRO TEMPERATO TRASPARENTE SENZA TELAIO) (tempered transparent glass without frame)	41	€ 66,00
114 693 *	ANTA VETRO ALTA DX o SX PER MOBILI ALTI right or left high glass door for high cabinets (VETRO TEMPERATO TRASPARENTE SENZA TELAIO) (tempered transparent glass without frame)	41	€ 99,00
114 694 *	ANTA VETRO ALTA DX o SX PER MOBILI ALTI + SERR. right or left high glass door for high cabinets + lock (VETRO TEMPERATO TRASPARENTE SENZA TELAIO) (tempered transparent glass without frame)	41	€ 110,00
114 695 *	ANTA VETRO MEDIA DX PER MOBILI H.158,3 + SERR. right medium glass door for cabinets H.158,3 cms + lock (VETRO TEMPERATO SATINATO CON TELAIO) (tempered satined glass with frame)	40	€ 134,00
114 696 *	ANTA VETRO MEDIA SX PER MOBILI H.158,3 + SERR. left medium glass door for cabinet H.158,3 cms + lock (VETRO TEMPERATO SATINATO CON TELAIO) (tempered satined glass with frame)	40	€ 134,00
114 702 *	ANTA VETRO SUPERIORE DX PER MOBILI ALTI + SERR. right upper medium glass door for high cabinets + lock (VETRO TEMPERATO SATINATO CON TELAIO) (tempered satined glass with frame)	40	€ 107,00
114 703 *	ANTA VETRO SUPERIORE SX PER MOBILI ALTI + SERR. left upper medium glass door for high cabinets + lock (VETRO TEMPERATO SATINATO CON TELAIO) (tempered satined glass with frame)	40	€ 107,00
114 704 *	COPPIA ANTE VETRO SUPERIORI PER MOBILI ALTI I + SERR. set of 2 upper medium glass doors for high cabinets + lock (VETRO TEMPERATO SATINATO CON TELAIO) (tempered satined glass with frame)	40	€ 210,00
114 705 *	COPPIA ANTE VETRO MEDIE PER MOBILI H.158,3 + SERR. set of 2 medium glass doors for cabinets H.158,3 + lock (VETRO TEMPERATO SATINATO CON TELAIO) (tempered satined glass with frame)	40	€ 265,00
114 710 *	ANTA VETRO ALTA DX PER MOBILI ALTI + SERR. right high glass door for high cabinets + lock (VETRO TEMPERATO SATINATO CON TELAIO) (tempered satined glass with frame)	41	€ 147,00
114 711 *	ANTA VETRO ALTA SX PER MOBILI ALTI + SERR. left high glass door for high cabinets + lock (VETRO TEMPERATO SATINATO CON TELAIO) (tempered satined glass with frame)	41	€ 147,00
114 714 *	COPPIA ANTE VETRO ALTE PER MOBILI ALTI + SERR. set of 2 high glass doors for high cabinets + lock (VETRO TEMPERATO SATINATO CON TELAIO) (tempered satined glass with frame)	41	€ 296,00
114 716 *	COPPIA ANTE VETRO MEDIE PER MOBILI H.119,8 + SERR. set of 2 medium glass doors for cabinets H.119,8 + lock (VETRO TEMPERATO SATINATO CON TELAIO) (tempered satined glass with frame)	40	€ 210,00
114 718 *	LIBRERIA SPALLA UNICA TERMINALE L.50 X H.235 terminal bookcase with shared side panel w 50 x h 235 cms PROF. CM 36,9 depth 36,9 cms	44	€ 317,00
114 722 *	LIBRERIA SPALLA UNICA CENTRALE L.47,5 X H.235 central bookcase with shared side panel w 47,5 x h 235 cms PROF. CM 36,9 depth 36,9 cms	44	€ 263,00
114 724 *	LIBRERIA SPALLA UNICA TERMINALE L.95 X H.235 terminal bookcase with shared side panel w 95 x h 235 cms PROF. CM 36,9 depth 36,9 cms	44	€ 417,00
114 728 *	LIBRERIA SPALLA UNICA CENTRALE L.92,5 X H.235 central bookcase with shared side panel w 92,5 x h 235 cms PROF. CM 36,9 depth 36,9 cms	44	€ 363,00
114 729 *	LIBRERIA SPALLA UNICA TERMINALE L.50 X H.270 terminal bookcase with shared side panel w 50 x h 270 cms PROF. CM 36,9 depth 36,9 cms	45	€ 355,00
114 731 *	LIBRERIA SPALLA UNICA CENTRALE L.47,5 X H.270 central bookcase with shared side panel w 47,5 x h 270 cms PROF. CM 36,9 depth 36,9 cms	45	€ 294,00
114 732 *	LIBRERIA SPALLA UNICA TERMINALE L.95 X H.270 terminal bookcase with shared side panel w 95 x h 270 cms PROF. CM 36,9 depth 36,9 cms	45	€ 478,00
114 733 *	LIBRERIA SPALLA UNICA CENTRALE L.92,5 X H.270 central bookcase with shared side panel w 92,5 x h 270 cms PROF. CM 36,9 depth 36,9 cms	45	€ 417,00
114 740 *	MOBILE ALTO A GIORNO L.45 (CARCASSA PER ANTE INTERE LEGNO) open high cabinet w 45 cms (structure for whole wooden doors) H.235	22	€ 211,00
114 741 *	MOBILE ALTO A GIORNO L.45 (CARCASSA PER ANTE SPEZZATE LEGNO E TUTTE LE ANTE VETRO) open high cabinet w 45 cms (structure for split wooden doors and all types glass doors) H.235	22	€ 211,00



\* = INDICARE IL CODICE FINITURA  
= complete with finish code

INDICE DEI CODICI codes index  
Mod. CONTENITORI UNIV. EVO  
Mod. Universal Cabinets EVO

CODICE code	DESCRIZIONE description	PAG. page	PREZZO price	
114 743 *	MOBILE ALTO A GIORNO L.45 (CARCASSA PER ANTE INTERE LEGNO) open high cabinet w 45 cms (structure for whole wooden doors)	H.235	PROF. CM 35 depth 35 cms	22 € 186,00
114 744 *	MOBILE ALTO A GIORNO L.45 (CARCASSA PER ANTE SPEZZATE LEGNO E TUTTE LE ANTE VETRO) open high cabinet w 45 cms (structure for split wooden doors and all types glass doors)	H.235	PROF. CM 35 depth 35 cms	22 € 186,00
114 745 *	MOBILE ALTO A GIORNO L.90 (CARCASSA PER ANTE INTERE LEGNO) open high cabinet w 90 cms (structure for whole wooden doors)	H.235	PROF. CM 44.5 depth 44.5 cms	24 € 301,00
114 746 *	MOBILE ALTO A GIORNO L.90 (CARCASSA PER ANTE SPEZZATE LEGNO E TUTTE LE ANTE VETRO) open high cabinet w 90 cms (structure for split wooden doors and all types glass doors)	H.235	PROF. CM 44.5 depth 44.5 cms	24 € 301,00
114 748 *	MOBILE ALTO A GIORNO L.90 (CARCASSA PER ANTE INTERE LEGNO) open high cabinet w 90 cms (structure for whole wooden doors)	H.235	PROF. CM 35 depth 35 cms	24 € 267,00
114 749 *	MOBILE ALTO A GIORNO L.90 (CARCASSA PER ANTE SPEZZATE LEGNO E TUTTE LE ANTE VETRO) open high cabinet w 90 cms (structure for split wooden doors and all types glass doors)	H.235	PROF. CM 35 depth 35 cms	24 € 267,00
114 750 *	MOBILE ALTO A GIORNO L.45 (CARCASSA PER ANTE INTERE LEGNO) open high cabinet w 45 cms (structure for whole wooden doors)	H.260	PROF. CM 44.5 depth 44.5 cms	26 € 233,00
114 751 *	MOBILE ALTO A GIORNO L.45 (CARCASSA PER ANTE SPEZZATE LEGNO E TUTTE LE ANTE VETRO) open high cabinet w 45 cms (structure for split wooden doors and all types glass doors)	H.260	PROF. CM 44.5 depth 44.5 cms	26 € 233,00
114 753 *	MOBILE ALTO A GIORNO L.45 (CARCASSA PER ANTE INTERE LEGNO) open high cabinet w 45 cms (structure for whole wooden doors)	H.260	PROF. CM 35 depth 35 cms	26 € 218,00
114 754 *	MOBILE ALTO A GIORNO L.45 (CARCASSA PER ANTE SPEZZATE LEGNO E TUTTE LE ANTE VETRO) open high cabinet w 45 cms (structure for split wooden doors and all types glass doors)	H.260	PROF. CM 35 depth 35 cms	26 € 218,00
114 755 *	MOBILE ALTO A GIORNO L.90 (CARCASSA PER ANTE INTERE LEGNO) open high cabinet w 90 cms (structure for whole wooden doors)	H.260	PROF. CM 44.5 depth 44.5 cms	27 € 341,00
114 756 *	MOBILE ALTO A GIORNO L.90 (CARCASSA PER ANTE SPEZZATE LEGNO E TUTTE LE ANTE VETRO) open high cabinet w 90 cms (structure for split wooden doors and all types glass doors)	H.260	PROF. CM 44.5 depth 44.5 cms	27 € 341,00
114 758 *	MOBILE ALTO A GIORNO L.90 (CARCASSA PER ANTE INTERE LEGNO) open high cabinet w 90 cms (structure for whole wooden doors)	H.260	PROF. CM 35 depth 35 cms	27 € 304,00
114 759 *	MOBILE ALTO A GIORNO L.90 (CARCASSA PER ANTE SPEZZATE LEGNO E TUTTE LE ANTE VETRO) open high cabinet w 90 cms (structure for split wooden doors and all types glass doors)	H.260	PROF. CM 35 depth 35 cms	27 € 304,00
114 761 *	MOBILE ALTO L.45 CON 1 ANTA BASSA LEGNO DX CON SERRATURA high cabinet w 45 cms with 1 low right wooden door with lock	H.235	PROF. CM 46.6 depth 46.6 cms	22 € 242,00
114 762 *	MOBILE ALTO L.45 CON 1 ANTA BASSA LEGNO SX CON SERRATURA high cabinet w 45 cms with 1 low left wooden door with lock	H.235	PROF. CM 46.6 depth 46.6 cms	22 € 242,00
114 763 *	MOBILE ALTO L.45 CON 2 ANTE LEGNO DX CON SERRATURE high cabinet w 45 cms with 2 right wooden doors with locks	H.235	PROF. CM 46.6 depth 46.6 cms	22 € 295,00
114 764 *	MOBILE ALTO L.45 CON 2 ANTE LEGNO SX CON SERRATURE high cabinet w 45 cms with 2 left wooden doors with locks	H.235	PROF. CM 46.6 depth 46.6 cms	22 € 295,00
114 765 *	MOBILE ALTO L.45 CON 1 ANTA LEGNO DX CON SERRATURA high cabinet w 45 cms with 1 right wooden door with lock	H.235	PROF. CM 46.6 depth 46.6 cms	22 € 249,00
114 766 *	MOBILE ALTO L.45 CON 1 ANTA LEGNO SX CON SERRATURA high cabinet w 45 cms with 1 left wooden door with lock	H.235	PROF. CM 46.6 depth 46.6 cms	22 € 249,00
114 767 *	MOBILE ALTO L.45 CON 2 ANTE LEGNO DX CON SERRATURE high cabinet w 45 cms with 2 right wooden doors with locks	H.235	PROF. CM 46.6 depth 46.6 cms	23 € 287,00
114 768 *	MOBILE ALTO L.45 CON 2 ANTE LEGNO SX CON SERRATURE high cabinet w 45 cms with 2 left wooden doors with locks	H.235	PROF. CM 46.6 depth 46.6 cms	23 € 287,00
114 769 *	MOBILE ALTO L.45 CON 1 ANTA LEGNO DX + 1 ANTA VETRO DX CON SERRATURE high cabinet w 45 cms with 1 right wooden door + 1 right glass door with locks	H.235	PROF. CM 46.6 depth 46.6 cms	23 € 356,00
114 770 *	MOBILE ALTO L.45 CON 1 ANTA LEGNO SX + 1 ANTA VETRO SX CON SERRATURE high cabinet w 45 cms with 1 left wooden door + 1 left glass door with locks	H.235	PROF. CM 46.6 depth 46.6 cms	23 € 356,00
114 771 *	MOBILE ALTO L.45 CON 1 ANTA LEGNO DX CON SERRATURA high cabinet w 45 cms with 1 right wooden door with lock	H.235	PROF. CM 46.6 depth 46.6 cms	23 € 301,00
114 772 *	MOBILE ALTO L.45 CON 1 ANTA LEGNO SX CON SERRATURA high cabinet w 45 cms with 1 left wooden door with lock	H.235	PROF. CM 46.6 depth 46.6 cms	23 € 301,00
114 774 *	MOBILE ALTO L.90 CON 2 ANTE BASSE LEGNO CON SERRATURA high cabinet w 90 cms with 2 low wooden doors with lock	H.235	PROF. CM 46.6 depth 46.6 cms	24 € 353,00
114 775 *	MOBILE ALTO L.90 CON 4 ANTE LEGNO CON SERRATURA high cabinet w 90 cms with 4 wooden doors with lock	H.235	PROF. CM 46.6 depth 46.6 cms	24 € 438,00
114 776 *	MOBILE ALTO L.90 CON 2 ANTE LEGNO CON SERRATURA high cabinet w 90 cms with 2 wooden doors with lock	H.235	PROF. CM 46.6 depth 46.6 cms	24 € 367,00
114 777 *	MOBILE ALTO L.90 CON 4 ANTE LEGNO CON SERRATURA high cabinet w 90 cms with 4 wooden doors with lock	H.235	PROF. CM 46.6 depth 46.6 cms	25 € 433,00
114 778 *	MOBILE ALTO L.90 CON 2 ANTE LEGNO + 2 ANTE VETRO CON SERRATURE high cabinet w 90 cms with 2 wooden doors + 2 glass doors with locks	H.235	PROF. CM 46.6 depth 46.6 cms	25 € 577,00
114 779 *	MOBILE ALTO L.90 CON 2 ANTE LEGNO CON SERRATURA high cabinet w 90 cms with 2 wooden doors with lock	H.235	PROF. CM 46.6 depth 46.6 cms	25 € 446,00
114 781 *	MOBILE ALTO L.45 CON 1 ANTA BASSA LEGNO DX CON SERRATURA high cabinet w 45 cms with 1 low right wooden door with lock	H.260	PROF. CM 46.6 depth 46.6 cms	26 € 264,00
114 782 *	MOBILE ALTO L.45 CON 1 ANTA BASSA LEGNO SX CON SERRATURA high cabinet w 45 cms with 1 low left wooden door with lock	H.260	PROF. CM 46.6 depth 46.6 cms	26 € 264,00
114 783 *	MOBILE ALTO L.45 CON 1 ANTA MEDIA LEGNO DX CON SERRATURA high cabinet w 45 cms with 1 medium right wooden door with lock	H.260	PROF. CM 46.6 depth 46.6 cms	26 € 271,00
114 784 *	MOBILE ALTO L.45 CON 1 ANTA MEDIA LEGNO SX CON SERRATURA high cabinet w 45 cms with 1 medium left wooden door with lock	H.260	PROF. CM 46.6 depth 46.6 cms	26 € 271,00
114 785 *	MOBILE ALTO L.45 CON 1 ANTA LEGNO DX CON SERRATURA high cabinet w 45 cms with 1 right wooden door with lock	H.260	PROF. CM 46.6 depth 46.6 cms	26 € 329,00
114 786 *	MOBILE ALTO L.45 CON 1 ANTA LEGNO SX CON SERRATURA high cabinet w 45 cms with 1 left wooden door with lock	H.260	PROF. CM 46.6 depth 46.6 cms	26 € 329,00
114 787 *	MOBILE ALTO L.90 CON 2 ANTE BASSE LEGNO CON SERRATURA high cabinet w 90 cms with 2 low wooden doors with lock	H.260	PROF. CM 46.6 depth 46.6 cms	27 € 393,00
114 788 *	MOBILE ALTO L.90 CON 2 ANTE MEDIE LEGNO CON SERRATURA high cabinet w 90 cms with 2 medium wooden doors with lock	H.260	PROF. CM 46.6 depth 46.6 cms	27 € 407,00
114 789 *	MOBILE ALTO L.90 CON 2 ANTE LEGNO CON SERRATURA high cabinet w 90 cms with 2 wooden doors with lock	H.260	PROF. CM 46.6 depth 46.6 cms	27 € 498,00
114 796 *	STRUTTURA METALLICA PER CONTENITORI FRRE STANDING L.45 metal structure for freestanding cabinets w 45 cms	H.14	PROF. CM 44.5 depth 44.5 cms	30 € 61,00
114 797 *	STRUTTURA METALLICA PER CONTENITORI FRRE STANDING L.90 metal structure for freestanding cabinets w 90 cms	H.14	PROF. CM 44.5 depth 44.5 cms	30 € 76,00
114 800 *	MOBILE BASSO A GIORNO L.45 open low cabinet w 45 cms		PROF. CM 44.5 depth 44.5 cms	12 € 77,00
114 801 *	MOBILE BASSO A GIORNO L.45 open low cabinet w 45 cms	H.81.5	PROF. CM 35 depth 35 cms	12 € 69,00
114 802 *	MOBILE BASSO L.45 CON 2 CASSETTI CLASSIFICATORI CON SERRATURA low cabinet w 45 cms with 2 file drawers with lock	H.81.5	PROF. CM 46.6 depth 46.6 cms	12 € 249,00
114 803 *	MOBILE BASSO L.45 CON 1 ANTA LEGNO DX CON SERRATURA low cabinet w 45 cms with 1 right wooden door with lock	H.81.5	PROF. CM 46.6 depth 46.6 cms	12 € 108,00
114 804 *	MOBILE BASSO L.45 CON 1 ANTA LEGNO SX CON SERRATURA low cabinet w 45 cms with 1 left wooden door with lock	H.81.5	PROF. CM 46.6 depth 46.6 cms	12 € 108,00
114 806 *	MOBILE BASSO L.90 CON 2 CASSETTI CLASSIFICATORI CON SERRATURA low cabinet w 90 cms with 2 file drawers with lock	H.81.5	PROF. CM 46.6 depth 46.6 cms	13 € 329,00
114 807 *	MOBILE BASSO L.90 CON 2 ANTE LEGNO CON SERRATURA low cabinet w 90 cms with 2 wooden doors with lock	H.81.5	PROF. CM 46.6 depth 46.6 cms	13 € 165,00
114 809 *	MOBILE BASSO L.45 CON 1 ANTA LEGNO DX CON SERRATURA, COMPLETO DI FIGORIFERO DA LT.38+GRIGLIA DI AERAZIONE low cabinet w 45 cms with right wooden door with lock, and refrigerator 38 liters+airing grid	H.81.5	PROF. CM 46.6 depth 46.6 cms	12 € 920,00
114 810 *	MOBILE BASSO A GIORNO L.90 open low cabinet w 90 cms	H.81.5	PROF. CM 44.5 depth 44.5 cms	13 € 113,00
114 811 *	MOBILE BASSO A GIORNO L.90 open low cabinet w 90 cms	H.81.5	PROF. CM 35 depth 35 cms	13 € 100,00

CONTENITORI  
UNIVERSALI EVO  
UNIVERSAL CABINETS EVO

\* = INDICARE IL CODICE FINITURA  
= complete with finish code

INDICE DEI CODICI codes index  
Mod. CONTENITORI UNIV. EVO  
Mod. Universal Cabinets EVO

CODICE code	DESCRIZIONE description	PAG. page	PREZZO price	
114 813 *	MOBILE MEDIO A GIORNO L.45 open medium cabinet w 45 cms	H.119,8	PROF. CM 44,5 depth 44,5 cms	14 € 110,00
114 814 *	MOBILE MEDIO A GIORNO L.45 open medium cabinet w 45 cms	H.119,8	PROF. CM 35 depth 35 cms	14 € 99,00
114 815 *	MOBILE MEDIO A GIORNO L.45 open medium cabinet w 45 cms	H.158,3	PROF. CM 44,5 depth 44,5 cms	16 € 138,00
114 816 *	MOBILE MEDIO A GIORNO L.45 open medium cabinet w 45 cms	H.158,3	PROF. CM 35 depth 35 cms	16 € 121,00
114 818 *	MOBILE MEDIO A GIORNO L.90 open medium cabinet w 90 cms	H.119,8	PROF. CM 44,5 depth 44,5 cms	15 € 159,00
114 819 *	MOBILE MEDIO A GIORNO L.90 open medium cabinet w 90 cms	H.119,8	PROF. CM 35 depth 35 cms	15 € 144,00
114 820 *	MOBILE MEDIO A GIORNO L.90 open medium cabinet w 90 cms	H.158,3	PROF. CM 44,5 depth 44,5 cms	17 € 205,00
114 821 *	MOBILE MEDIO A GIORNO L.90 open medium cabinet w 90 cms	H.158,3	PROF. CM 35 depth 35 cms	17 € 182,00
114 822 *	MOBILE MEDIO L.90 X H.158,3 CON SERRANDINA + SERR. medium cabinet w 90 x h 158,3 cms with rolling shutter + lock			17 € 521,00
114 825 *	MOBILE ALTO A GIORNO L.45 (CARCASSA PER ANTE INTERE LEGNO) open high cabinet w 45 cms (structure for whole wooden doors)	H.196,7	PROF. CM 44,5 depth 44,5 cms	18 € 166,00
114 826 *	MOBILE ALTO A GIORNO L.45 (CARCASSA PER ANTE SPEZZATE LEGNO E TUTTE LE ANTE VETRO) open high cabinet w 45 cms (structure for split wooden doors and all types glass doors)	H.196,7	PROF. CM 44,5 depth 44,5 cms	18 € 166,00
114 828 *	MOBILE ALTO A GIORNO L.45 (CARCASSA PER ANTE INTERE LEGNO) open high cabinet w 45 cms (structure for whole wooden doors)	H.196,7	PROF. CM 35 depth 35 cms	18 € 139,00
114 829 *	MOBILE ALTO A GIORNO L.45 (CARCASSA PER ANTE SPEZZATE LEGNO E TUTTE LE ANTE VETRO) open high cabinet w 45 cms (structure for split wooden doors and all types glass doors)	H.196,7	PROF. CM 35 depth 35 cms	18 € 139,00
114 830 *	MOBILE MEDIO L.45 CON 2 CASSETTI CLASSIFICATORI CON SERRATURA medium cabinet w 45 cms with 2 file drawers with lock	H.119,8	PROF. CM 46,6 depth 46,6 cms	14 € 268,00
114 831 *	MOBILE MEDIO L.45 CON 1 ANTA BASSA LEGNO DX CON SERRATURA medium cabinet w 45 cms with 1 right low wooden door with lock	H.119,8	PROF. CM 46,6 depth 46,6 cms	14 € 141,00
114 832 *	MOBILE MEDIO L.45 CON 1 ANTA BASSA LEGNO SX CON SERRATURA medium cabinet w 45 cms with 1 left low wooden door with lock	H.119,8	PROF. CM 46,6 depth 46,6 cms	14 € 141,00
114 833 *	MOBILE MEDIO L.45 CON 1 ANTA LEGNO DX CON SERRATURA medium cabinet w 45 cms with 1 right wooden door with lock	H.119,8	PROF. CM 46,6 depth 46,6 cms	14 € 148,00
114 834 *	MOBILE MEDIO L.45 CON 1 ANTA LEGNO SX CON SERRATURA medium cabinet w 45 cms with 1 left wooden door with lock	H.119,8	PROF. CM 46,6 depth 46,6 cms	14 € 148,00
114 835 *	MOBILE ALTO A GIORNO L.90 (CARCASSA PER ANTE INTERE LEGNO) open high cabinet w 90 cms (structure for whole wooden doors)	H.196,7	PROF. CM 44,5 depth 44,5 cms	20 € 242,00
114 836 *	MOBILE ALTO A GIORNO L.90 (CARCASSA PER ANTE SPEZZATE LEGNO E TUTTE LE ANTE VETRO) open high cabinet w 90 cms (structure for split wooden doors and all types glass doors)	H.196,7	PROF. CM 44,5 depth 44,5 cms	20 € 242,00
114 838 *	MOBILE ALTO A GIORNO L.90 (CARCASSA PER ANTE INTERE LEGNO) open high cabinet w 90 cms (structure for whole wooden doors)	H.196,7	PROF. CM 35 depth 35 cms	20 € 214,00
114 839 *	MOBILE ALTO A GIORNO L.90 (CARCASSA PER ANTE SPEZZATE LEGNO E TUTTE LE ANTE VETRO) open high cabinet w 90 cms (structure for split wooden doors and all types glass doors)	H.196,7	PROF. CM 35 depth 35 cms	20 € 214,00
114 840 *	MOBILE ALTO L.90 X H.196,7 CON SERRANDINA + SERR. high cabinet w 90 x h 196,7 cms with rolling shutter + lock			20 € 595,00
114 842 *	MOBILE MEDIO L.45 CON 1 ANTA VETRO DX CON SERRATURA medium cabinet w 45 cms with 1 right glass door with lock	H.119,8	PROF. CM 46,6 depth 46,6 cms	14 € 217,00
114 843 *	MOBILE MEDIO L.45 CON 1 ANTA VETRO SX CON SERRATURA medium cabinet w 45 cms with 1 left glass door with lock	H.119,8	PROF. CM 46,6 depth 46,6 cms	14 € 217,00
114 844 *	MOBILE MEDIO L.90 CON 2 CASSETTI CLASSIFICATORI CON SERRATURA medium cabinet w 90 cms with 2 file drawers with lock	H.119,8	PROF. CM 46,6 depth 46,6 cms	15 € 354,00
114 846 *	MOBILE MEDIO L.90 CON 2 ANTE BASSE LEGNO CON SERRATURA medium cabinet w 90 cms with 2 low wooden doors with lock	H.119,8	PROF. CM 46,6 depth 46,6 cms	15 € 211,00
114 847 *	MOBILE MEDIO L.90 CON 2 ANTE LEGNO CON SERRATURA medium cabinet w 90 cms with 2 wooden doors with lock	H.119,8	PROF. CM 46,6 depth 46,6 cms	15 € 225,00
114 848 *	MOBILE MEDIO L.90 CON 2 ANTE VETRO CON SERRATURA medium cabinet w 90 cms with 2 glass doors with lock	H.119,8	PROF. CM 46,6 depth 46,6 cms	15 € 369,00
114 851 *	MOBILE MEDIO L.45 CON 2 CASSETTI CLASSIFICATORI CON SERRATURA medium cabinet w 45 cms with 2 file drawers with lock	H.158,3	PROF. CM 46,6 depth 46,6 cms	16 € 304,00
114 852 *	MOBILE MEDIO L.45 CON 2 CASSETTI CLASSIFICATORI + 1 ANTA LEGNO DX CON SERRATURE medium cabinet w 45 cms with 2 file drawers + 1 right wooden door with locks	H.158,3	PROF. CM 46,6 depth 46,6 cms	16 € 335,00
114 853 *	MOBILE MEDIO L.45 CON 2 CASSETTI CLASSIFICATORI + 1 ANTA LEGNO SX CON SERRATURE medium cabinet w 45 cms with 2 file drawers + 1 left wooden door with locks	H.158,3	PROF. CM 46,6 depth 46,6 cms	16 € 335,00
114 856 *	MOBILE MEDIO L.45 CON 1 ANTA BASSA LEGNO DX CON SERRATURA medium cabinet w 45 cms with 1 right low wooden door with lock	H.158,3	PROF. CM 46,6 depth 46,6 cms	16 € 169,00
114 857 *	MOBILE MEDIO L.45 CON 1 ANTA BASSA LEGNO SX CON SERRATURA medium cabinet w 45 cms with 1 left low wooden door with lock	H.158,3	PROF. CM 46,6 depth 46,6 cms	16 € 169,00
114 858 *	MOBILE MEDIO L.45 CON 2 ANTE BASSE LEGNO DX CON SERRATURE medium cabinet w 45 cms with 2 right low wooden doors with locks	H.158,3	PROF. CM 46,6 depth 46,6 cms	16 € 200,00
114 859 *	MOBILE MEDIO L.45 CON 2 ANTE BASSE LEGNO SX CON SERRATURE medium cabinet w 45 cms with 2 left low wooden doors with locks	H.158,3	PROF. CM 46,6 depth 46,6 cms	16 € 200,00
114 860 *	MOBILE MEDIO L.45 CON 1 ANTA LEGNO DX CON SERRATURA medium cabinet w 45 cms with 1 right wooden door with lock	H.158,3	PROF. CM 46,6 depth 46,6 cms	16 € 191,00
114 861 *	MOBILE MEDIO L.45 CON 1 ANTA LEGNO SX CON SERRATURA medium cabinet w 45 cms with 1 left wooden door with lock	H.158,3	PROF. CM 46,6 depth 46,6 cms	16 € 191,00
114 862 *	MOBILE MEDIO L.45 CON 1 ANTA VETRO DX CON SERRATURA medium cabinet w 45 cms with 1 right glass door with lock	H.158,3	PROF. CM 46,6 depth 46,6 cms	16 € 272,00
114 863 *	MOBILE MEDIO L.45 CON 1 ANTA VETRO SX CON SERRATURA medium cabinet w 45 cms with 1 left glass door with lock	H.158,3	PROF. CM 46,6 depth 46,6 cms	16 € 272,00
114 864 *	MOBILE MEDIO L.90 CON 2 CASSETTI CLASSIFICATORI CON SERRATURA medium cabinet w 90 cms with 2 file drawers with lock	H.158,3	PROF. CM 46,6 depth 46,6 cms	17 € 403,00
114 865 *	MOBILE MEDIO L.90 CON 2 CASSETTI CLASSIFICATORI + 2 ANTE LEGNO CON SERRATURE medium cabinet w 90 cms with 2 file drawers + 2 wooden doors with locks	H.158,3	PROF. CM 46,6 depth 46,6 cms	17 € 459,00
114 866 *	MOBILE MEDIO L.90 CON 2 ANTE BASSE LEGNO CON SERRATURA medium cabinet w 90 cms with 2 low wooden doors with lock	H.158,3	PROF. CM 46,6 depth 46,6 cms	17 € 257,00
114 868 *	MOBILE MEDIO L.90 CON 4 ANTE BASSE LEGNO CON SERRATURA medium cabinet w 90 cms with 4 low wooden doors with lock	H.158,3	PROF. CM 46,6 depth 46,6 cms	17 € 313,00
114 869 *	MOBILE MEDIO L.90 CON 2 ANTE LEGNO CON SERRATURA medium cabinet w 90 cms with 2 wooden doors with lock	H.158,3	PROF. CM 46,6 depth 46,6 cms	17 € 290,00
114 874 *	MOBILE MEDIO L.90 CON 2 ANTE VETRO CON SERRATURA medium cabinet w 90 cms with 2 glass doors with lock	H.158,3		17 € 470,00
114 875 *	MOBILE ALTO L.45 CON 1 ANTA BASSA LEGNO DX CON SERRATURA high cabinet w 45 cms with 1 low right wooden door with lock	H.196,7	PROF. CM 46,6 depth 46,6 cms	18 € 197,00
114 876 *	MOBILE ALTO L.45 CON 1 ANTA BASSA LEGNO SX CON SERRATURA high cabinet w 45 cms with 1 low left wooden door with lock	H.196,7	PROF. CM 46,6 depth 46,6 cms	18 € 197,00
114 877 *	MOBILE ALTO L.45 CON 2 ANTE LEGNO DX CON SERRATURE high cabinet w 45 cms with 2 right wooden doors with locks	H.196,7	PROF. CM 46,6 depth 46,6 cms	18 € 235,00
114 878 *	MOBILE ALTO L.45 CON 2 ANTE LEGNO SX CON SERRATURE high cabinet w 45 cms with 2 left wooden doors with locks	H.196,7	PROF. CM 46,6 depth 46,6 cms	18 € 235,00
114 879 *	MOBILE ALTO L.45 CON 1 ANTA BASSA LEGNO DX + 1 ANTA VETRO DX CON SERRATURE high cabinet w 45 cms with 1 low right wooden door + 1 right glass door with locks	H.196,7	PROF. CM 46,6 depth 46,6 cms	18 € 304,00
114 880 *	MOBILE ALTO L.45 CON 1 ANTA BASSA LEGNO SX + 1 ANTA VETRO SX CON SERRATURE high cabinet w 45 cms with 1 low left wooden door + 1 left glass door with locks	H.196,7	PROF. CM 46,6 depth 46,6 cms	18 € 304,00
114 881 *	MOBILE ALTO L.45 CON 1 ANTA LEGNO DX CON SERRATURA high cabinet w 45 cms with 1 right wooden door with lock	H.196,7	PROF. CM 46,6 depth 46,6 cms	19 € 204,00

\* = INDICARE IL CODICE FINITURA  
= complete with finish code

INDICE DEI CODICI codes index  
Mod. CONTENTORI UNIV. EVO  
Mod. Universal Cabinets EVO

CODICE code	DESCRIZIONE description	PAG. page	PREZZO price	
114 882 *	MOBILE ALTO L.45 CON 1 ANTA LEGNO SX CON SERRATURA high cabinet w 45 cms with 1 left wooden door with lock	H.196,7	PROF. CM 46,6 depth 46,6 cms	19 € 204,00
114 883 *	MOBILE ALTO L.45 CON 2 ANTE LEGNO DX CON SERRATURA high cabinet w 45 cms with 2 right wooden doors with lock	H.196,7	PROF. CM 46,6 depth 46,6 cms	19 € 235,00
114 884 *	MOBILE ALTO L.45 CON 2 ANTE LEGNO SX CON SERRATURA high cabinet w 45 cms with 2 left wooden doors with lock	H.196,7	PROF. CM 46,6 depth 46,6 cms	19 € 235,00
114 885 *	MOBILE ALTO L.45 CON 1 ANTA LEGNO DX CON SERRATURA high cabinet w 45 cms with 1 right wooden door with lock	H.196,7	PROF. CM 46,6 depth 46,6 cms	19 € 245,00
114 886 *	MOBILE ALTO L.45 CON 1 ANTA LEGNO SX CON SERRATURA high cabinet w 45 cms with 1 left wooden door with lock	H.196,7	PROF. CM 46,6 depth 46,6 cms	19 € 245,00
114 887 *	MOBILE ALTO L.45 CON 1 ANTA VETRO DX CON SERRATURA high cabinet w 45 cms with 1 right glass door with lock	H.196,7	PROF. CM 46,6 depth 46,6 cms	19 € 313,00
114 888 *	MOBILE ALTO L.45 CON 1 ANTA VETRO SX CON SERRATURA high cabinet w 45 cms with 1 left glass door with lock	H.196,7	PROF. CM 46,6 depth 46,6 cms	19 € 313,00
114 889 *	MOBILE ALTO L.90 CON 2 ANTE BASSE LEGNO CON SERRATURA high cabinet w 90 cms with 2 low wooden doors with lock	H.196,7	PROF. CM 46,6 depth 46,6 cms	20 € 294,00
114 891 *	MOBILE ALTO L.90 CON 4 ANTE LEGNO CON SERRATURA high cabinet w 90 cms with 4 wooden doors with lock	H.196,7	PROF. CM 46,6 depth 46,6 cms	20 € 360,00
114 892 *	MOBILE ALTO L.90 CON 2 ANTE BASSE LEGNO + 2 ANTE VETRO CON SERRATURE high cabinet w 90 cms with 2 low wooden doors + 2 glass doors with locks	H.196,7	PROF. CM 46,6 depth 46,6 cms	20 € 504,00
114 893 *	MOBILE ALTO L.90 CON 2 ANTE LEGNO CON SERRATURA high cabinet w 90 cms with 2 wooden doors with lock	H.196,7	PROF. CM 46,6 depth 46,6 cms	21 € 308,00
114 894 *	MOBILE ALTO L.90 CON 4 ANTE LEGNO CON SERRATURA high cabinet w 90 cms with 4 wooden doors with lock	H.196,7	PROF. CM 46,6 depth 46,6 cms	21 € 364,00
114 895 *	MOBILE ALTO L.90 CON 2 ANTE LEGNO CON SERRATURA high cabinet w 90 cms with 2 wooden doors with lock	H.196,7	PROF. CM 46,6 depth 46,6 cms	21 € 367,00
114 896 *	MOBILE ALTO PORTA-ABITI L.90 CON 2 ANTE LEGNO CON SERRATURA high cabinet w 90 cms with wardrobe and 2 wooden doors with lock	H.196,7	PROF. CM 46,6 depth 46,6 cms	21 € 341,00
114 897 *	MOBILE ALTO L.90 CON 2 ANTE VETRO CON SERRATURA high cabinet w 90 cms with 2 glass doors with lock	H.196,7	PROF. CM 46,6 depth 46,6 cms	21 € 538,00
114 903 *	MOBILE BASSO A GIORNO L.45 SENZA RIPIANO REGISTRABILE open low cabinet w 45 cms without adjustable shelf	H.81,5	PROF. CM 44,5 depth 44,5 cms	28 € 70,00
114 904 *	MOBILE BASSO A GIORNO L.90 SENZA RIPIANO REGISTRABILE open low cabinet w 90 cms without adjustable shelf	H.81,5	PROF. CM 44,5 depth 44,5 cms	28 € 97,00
114 906 *	MOBILE MEDIO A GIORNO L.45 SENZA RIPIANI REGISTRABILI open medium cabinet w 45 cms without adjustable shelves	H.119,8	PROF. CM 44,5 depth 44,5 cms	28 € 96,00
114 908 *	MOBILE MEDIO A GIORNO L.90 SENZA RIPIANI REGISTRABILI open medium cabinet w 90 cms without adjustable shelves	H.119,8	PROF. CM 44,5 depth 44,5 cms	28 € 138,00
114 909 *	MOBILE MEDIO A GIORNO L.45 SENZA RIPIANI REGISTRABILI open medium cabinet w 45 cms without adjustable shelves	H.158,3	PROF. CM 44,5 depth 44,5 cms	28 € 118,00
114 911 *	MOBILE MEDIO A GIORNO L.90 SENZA RIPIANI REGISTRABILI open medium cabinet w 90 cms without adjustable shelves	H.158,3	PROF. CM 44,5 depth 44,5 cms	28 € 166,00
114 912 *	MOBILE ALTO A GIORNO L.45 SENZA RIPIANI REGISTRABILI (CARCASSA PER ANTE INTERE LEGNO) open high cabinet w 45 cms without adjustable shelves (structure for whole wooden doors)	H.196,7	PROF. CM 44,5 depth 44,5 cms	29 € 138,00
114 913 *	MOBILE ALTO A GIORNO L.45 SENZA RIPIANI REGISTRABILI (CARCASSA PER ANTE SPEZZATE LEGNO E TUTTE LE ANTE VETRO) open high cabinet w 45 cms without adjustable shelves (structure for split wooden doors and all types glass doors)	H.196,7	PROF. CM 44,5 depth 44,5 cms	29 € 138,00
114 914 *	MOBILE ALTO A GIORNO L.90 SENZA RIPIANI REGISTRABILI (CARCASSA PER ANTE INTERE LEGNO) open high cabinet w 90 cms without adjustable shelves (structure for whole wooden doors)	H.196,7	PROF. CM 44,5 depth 44,5 cms	29 € 189,00
114 915 *	MOBILE ALTO A GIORNO L.90 SENZA RIPIANI REGISTRABILI (CARCASSA PER ANTE SPEZZATE LEGNO E TUTTE LE ANTE VETRO) open high cabinet w 90 cms without adjustable shelves (structure for split wooden doors and all types glass doors)	H.196,7	PROF. CM 44,5 depth 44,5 cms	29 € 189,00
114 916 *	MOBILE ALTO A GIORNO L.45 SENZA RIPIANI REGISTRABILI (CARCASSA PER ANTE INTERE LEGNO) open high cabinet w 45 cms without adjustable shelves (structure for whole wooden doors)	H.235	PROF. CM 44,5 depth 44,5 cms	29 € 169,00
114 917 *	MOBILE ALTO A GIORNO L.45 SENZA RIPIANI REGISTRABILI (CARCASSA PER ANTE SPEZZATE LEGNO E TUTTE LE ANTE VETRO) open high cabinet w 45 cms without adjustable shelves (structure for split wooden doors and all types glass doors)	H.235	PROF. CM 44,5 depth 44,5 cms	29 € 169,00
114 918 *	MOBILE ALTO A GIORNO L.90 SENZA RIPIANI REGISTRABILI (CARCASSA PER ANTE INTERE LEGNO) open high cabinet w 90 cms without adjustable shelves (structure for whole wooden doors)	H.235	PROF. CM 44,5 depth 44,5 cms	29 € 226,00
114 919 *	MOBILE ALTO A GIORNO L.90 SENZA RIPIANI REGISTRABILI (CARCASSA PER ANTE SPEZZATE LEGNO E TUTTE LE ANTE VETRO) open high cabinet w 90 cms without adjustable shelves (structure for split wooden doors and all types glass doors)	H.235	PROF. CM 44,5 depth 44,5 cms	29 € 226,00
114 920 *	MOBILE ALTO A GIORNO L.45 SENZA RIPIANI REGISTRABILI (CARCASSA PER ANTE INTERE LEGNO) open high cabinet w 45 cms without adjustable shelves (structure for whole wooden doors)	H.260	PROF. CM 44,5 depth 44,5 cms	29 € 185,00
114 921 *	MOBILE ALTO A GIORNO L.45 SENZA RIPIANI REGISTRABILI (CARCASSA PER ANTE SPEZZATE LEGNO E TUTTE LE ANTE VETRO) open high cabinet w 45 cms without adjustable shelves (structure for split wooden doors and all types glass doors)	H.260	PROF. CM 44,5 depth 44,5 cms	29 € 185,00
114 922 *	MOBILE ALTO A GIORNO L.90 SENZA RIPIANI REGISTRABILI (CARCASSA PER ANTE INTERE LEGNO) open high cabinet w 90 cms without adjustable shelves (structure for whole wooden doors)	H.260	PROF. CM 44,5 depth 44,5 cms	29 € 249,00
114 923 *	MOBILE ALTO A GIORNO L.90 SENZA RIPIANI REGISTRABILI (CARCASSA PER ANTE SPEZZATE LEGNO E TUTTE LE ANTE VETRO) open high cabinet w 90 cms without adjustable shelves (structure for split wooden doors and all types glass doors)	H.260	PROF. CM 44,5 depth 44,5 cms	29 € 249,00
114 924 *	ANTA BASSA DX O SX SENZA SERRATURA (REVERSIBILE) right or left low wooden door without lock (reversible)	H.38	PER LIBRERIE SPALLA UNICA for bookcases with shared side panel	48 € 20,00
114 925 *	ANTA BASSA DX + SERR. right low wooden door + lock	H.76,4	PER LIBRERIE SPALLA UNICA for bookcases with shared side panel	48 € 34,00
114 926 *	ANTA BASSA SX + SERR. left low wooden door + lock	H.76,4	PER LIBRERIE SPALLA UNICA for bookcases with shared side panel	48 € 34,00
114 927 *	ANTA BASSA DX O SX right or left low wooden door	H.76,4	PER LIBRERIE SPALLA UNICA for bookcases with shared side panel	48 € 28,00
114 928 *	COPPIA ANTE BASSE + SERR. Set of 2 low wooden doors + lock	H.76,4	PER LIBRERIE SPALLA UNICA for bookcases with shared side panel	48 € 57,00
114 929 *	COPPIA ANTE BASSE Set of 2 low wooden doors	H.76,4	PER LIBRERIE SPALLA UNICA for bookcases with shared side panel	48 € 51,00
114 930 *	ANTA MEDIA SUPERIORE DX + SERRATURA right upper medium wooden door + lock	H.114,8	PER LIBRERIE SPALLA UNICA for bookcases with shared side panel	49 € 41,00
114 931 *	ANTA MEDIA SUPERIORE SX + SERRATURA left upper medium wooden door + lock	H.114,8	PER LIBRERIE SPALLA UNICA for bookcases with shared side panel	49 € 41,00
114 932 *	ANTA MEDIA SUPERIORE DX O SX right or left upper medium wooden door	H.114,8	PER LIBRERIE SPALLA UNICA for bookcases with shared side panel	49 € 34,00
114 933 *	COPPIA ANTE MEDIE SUPERIORI + SERRATURA set of 2 upper medium wooden doors + lock	H.114,8	PER LIBRERIE SPALLA UNICA for bookcases with shared side panel	49 € 72,00
114 934 *	COPPIA ANTE MEDIE SUPERIORI set of 2 upper medium wooden doors	H.114,8	PER LIBRERIE SPALLA UNICA for bookcases with shared side panel	49 € 66,00
114 935 *	COPPIA ANTE MEDIE + SERR. set of 2 medium wooden doors + lock	H.114,8	PER LIBRERIE SPALLA UNICA for bookcases with shared side panel	49 € 72,00
114 936 *	ANTA MEDIA DX H.153,2 + SERR. medium right wooden door h.153,2 + lock	H.153,2	PER LIBRERIE SPALLA UNICA for bookcases with shared side panel	50 € 58,00
114 937 *	ANTA MEDIA SX H.153,2 + SERR. medium left wooden door h.153,2 + lock	H.153,2	PER LIBRERIE SPALLA UNICA for bookcases with shared side panel	50 € 58,00

CONTENTORI UNIVERSALI EVO  
Universal Cabinets EVO

\* = INDICARE IL CODICE FINITURA  
 = complete with finish code

CODICE code	DESCRIZIONE description	PAG. page	PREZZO price	
114 938 *	ANTA MEDIA DX o SX H.153,2 right or left medium wooden door H.153,2	H.153,2	PER LIBRERIE SPALLA UNICA for bookcases with shared side panel	50 € 52,00
114 939 *	COPPIA ANTE MEDIE H.153,2 + SERR. set of 2 medium wooden doors H.153,2 + lock	H.153,2	PER LIBRERIE SPALLA UNICA for bookcases with shared side panel	50 € 94,00
114 940 *	COPPIA ANTE MEDIE H.153,2 set of 2 medium wooden doors H.153,2	H.153,2	PER LIBRERIE SPALLA UNICA for bookcases with shared side panel	50 € 88,00
114 941 *	ANTA MEDIA SUPERIORE DX + SERRATURA right upper medium wooden door + lock	H.153,2	PER LIBRERIE SPALLA UNICA for bookcases with shared side panel	51 € 58,00
114 942 *	ANTA MEDIA SUPERIORE SX + SERRATURA left upper medium wooden door + lock	H.153,2	PER LIBRERIE SPALLA UNICA for bookcases with shared side panel	51 € 58,00
114 943 *	ANTA MEDIA SUPERIORE DX o SX right or left upper medium wooden door	H.153,2	PER LIBRERIE SPALLA UNICA for bookcases with shared side panel	51 € 52,00
114 944 *	COPPIA ANTE MEDIE SUPERIORI + SERRATURA set of 2 upper medium wooden doors + lock	H.153,2	PER LIBRERIE SPALLA UNICA for bookcases with shared side panel	51 € 94,00
114 945 *	COPPIA ANTE MEDIE SUPERIORI set of 2 upper medium wooden doors	H.153,2	PER LIBRERIE SPALLA UNICA for bookcases with shared side panel	51 € 88,00
114 946 *	ANTA VETRO MEDIA DX PER MOBILI H.153,2 + SERR. right medium glass door for cabinets H.153,2 cms + lock	H.153,2	PER LIBRERIE SPALLA UNICA for bookcases with shared side panel	52 € 134,00
114 947 *	ANTA VETRO MEDIA SX PER MOBILI H.153,2 + SERR. left medium glass door for cabinet H.153,2 cms + lock	H.153,2	PER LIBRERIE SPALLA UNICA for bookcases with shared side panel	52 € 134,00
114 948 *	COPPIA ANTE VETRO MEDIE PER MOBILI H.153,2 + SERR. set of 2 medium glass doors for cabinets H.153,2 + lock	H.153,2	PER LIBRERIE SPALLA UNICA for bookcases with shared side panel	52 € 265,00
114 949 *	ANTA VETRO SUPERIORE DX PER MOBILI ALTI + SERR. right upper medium glass door for high cabinets + lock	H.114,8	PER LIBRERIE SPALLA UNICA for bookcases with shared side panel	52 € 107,00
114 950 *	ANTA VETRO SUPERIORE SX PER MOBILI ALTI + SERR. left upper medium glass door for high cabinets + lock	H.114,8	PER LIBRERIE SPALLA UNICA for bookcases with shared side panel	52 € 107,00
114 951 *	COPPIA ANTE VETRO SUPERIORI PER MOBILI ALTI + SERR. set of 2 upper medium glass doors for high cabinets + lock	H.114,8	PER LIBRERIE SPALLA UNICA for bookcases with shared side panel	52 € 210,00
114 952 *	COPPIA ANTE VETRO MEDIE + SERR. set of 2 medium glass doors + lock	H.114,8	PER LIBRERIE SPALLA UNICA for bookcases with shared side panel	52 € 210,00
114 954 *	BUSSOLOTTO L.90 PER MOBILI SPALLA UNICA modular unit w 90 cms for cabinets with shared side panel			47 € 141,00
114 956 *	CUSCINO PER CASSETTIERE SU RUOTE (CAT. A) cushion for pedestal on wheels (CAT.A)			10 € 44,00
114 956 *	CUSCINO PER CASSETTIERE SU RUOTE (CAT.F) cushion for pedestal on wheels (CAT.F)			10 € 51,00
114 957 *	CUSCINO PER MOBILI DI SERVIZIO ART.188-189 (CAT. A) cushion for service units art.188-189 (CAT. A)			10 € 52,00
114 957 *	CUSCINO PER MOBILI DI SERVIZIO ART.188-189 (CAT. F) cushion for service units art.188-189 (CAT. F)			10 € 63,00
114 980 *	KIT FISSAGGIO A MURO PER MOBILI ALTI fixing kit to the wall for high cabinets			42 € 14,00
114 981 *	KIT FISSAGGIO A MURO PER MOBILI SPALLA UNICA wall fixing kit for cabinets with shared element			47 € 14,00
114 986 *	MOBILE MEDIO CON ANTE SCORREVOLI + SERR. medium cabinet with sliding doors + lock	H.121,6		43 € 648,00
114 987 *	MOBILE ALTO CON ANTE SCORREVOLI + SERR. high cabinet with sliding doors + lock	H.198,5		43 € 911,00
<b>KIT FERRAMENTA / fittings kit</b>				
171 058 *	CHIAVE PER STRAZIONE CILINDRO SERRATURA key for extraction cylinder lock			42 € 10,00
171 059 *	CILINDRO SERRATURA ESTRAIBILE PER CHIAVI UGUALI extractable cylinder lock for keys alike			42 € 9,00
171 088 *	KIT COPRIFORI PER MOBILI set of hole cover caps for cabinets			42 € 5,00
<b>OYO</b>				
175 105 *	5° OPZIONALE NERA PER CASSETTIERA CLASSIFICATORE fifth optional black wheel for file-pedestal			9 € 13,00
175 131 *	RIPIANO IN METALLO PER MOBILI L.90 metal shelf for cabinets w 90 cms			31 € 46,00
175 132 *	RIPIANO IN METALLO PER MOBILI L.45 metal shelf for cabinets w 45 cms			31 € 35,00
175 186 *	PORTA CANCELLERIA INTERNO PER CASSETTIERE internal stationary holder for drawers			9 € 18,00



LISTINO 2018  
PRICE LIST

# POINT reception

Design  
STUDIO SI

Engineering  
C.S.R. LAS MOBILI

POINT  
reception

Conforme al DLGS 81/2008 (già 626/'94)  
apply to RULE 81/2008 (626/'94)

## IMPORTANTE / it's very important



Certificato 04/16

SULL'ORDINE INDICARE SEMPRE IL CODICE COMPLETO A 9 CIFRE  
always indicate on the order the complete 9-digit code

ESEMPIO: PER ORDINARE 1 RECEPTION **ART.019** BIANCA INDICARE IL CODICE =  
example: to order 1 RECEPTION **ART.019** WHITE indicate the code =

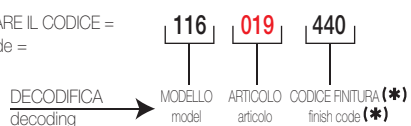

In vigore dal:  
Valid from:  
01/01/2018

Valido fino a nuova emissione  
Valid until new emission

---

---

## SOMMARIO / summary

<b>CARTELLA COLORI</b> .....	<b>3</b>
<i>colours samples card</i>	
<b>ABBINAMENTI COLORI</b> .....	<b>3</b>
<i>matching colours</i>	
<b>RECEPTION</b> .....	<b>4</b>
<i>reception</i>	
<b>ALLUNGHI RECEPTION</b> .....	<b>5</b>
<i>extension reception</i>	
<b>MENSOLE PER RECEPTION LINEARI e KIT LED</b> .....	<b>5</b>
<i>shelves for linear reception ad led kit</i>	
<b>ESEMPI DI COMBINABILITA'</b> .....	<b>6</b>
<i>examples of compositions</i>	
<b>VASCHETTA PASSACAVI e KIT ELETTRIFICAZIONE</b> .....	<b>7</b>
<i>cable-tray and electrification kit</i>	
<b>INDICE DEI CODICI</b> .....	<b>9</b>
<i>codes index</i>	

**N.B.: CASSETTIERE SU RUOTE, MOBILI CONTENITORI  
E LIBRERIE A SPALLA UNICA**

**SONO INSERITI NEL CAPITOLO "CONTENITORI UNIVERSALI EVO"**

**PLEASE NOTE: you can find pedestal on wheels, cabinet models  
and bookcases with shared side panel in the section "UNIVERSAL CABINETS EVO"**

**CARTELLA COLORI**  
colours samples card



COD. 03  
ROVERE | OAK



COD. 44  
STONE GREY | STONE GREY

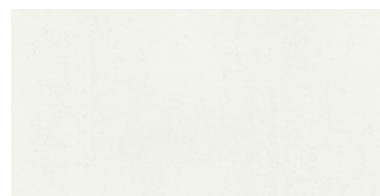

COD. 69  
BIANCO BR. | BR. WHITE



COD. 04  
ROVERE GREY | GREY OAK



COD. 45  
WENGÉ | WENGÉ



COD. 06  
NOCE PAVIA | PAVIA WALNUT



COD. 55  
ANTRACITE | ANTHRACITE

POINT  
reception

ABBINAMENTI COLORI <i>matching colours</i>	COLORI LEGNI <i>wooden colours</i>						
	ROVERE <i>oak</i>	ROVERE GREY <i>grey oak</i>	NOCE PAVIA <i>pavia walnut</i>	WENGÉ <i>wenge</i>	STONE GREY <i>stone grey</i>	ANTRACITE <i>anthracite</i>	BIANCO BR. <i>br. white</i>
COMPONENTI <i>components</i>							
PIANI DI LAVORO <i>desktop</i>	◇	◇	◇	◇	◇		◇
PANNELLI VERTICALI E FIANCHI SOTTOPIANO <i>vertical panels and undertop side panels</i>			◇		◇	◇	◇
MENSOLE <i>shelves</i>	◇	◇	◇	◇	◇	◇	◇

**RECEPTION**
**PIANI sp. 25mm**  
**tops thick. 25mm**

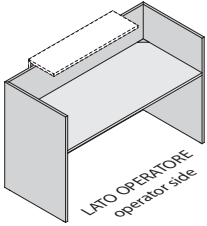
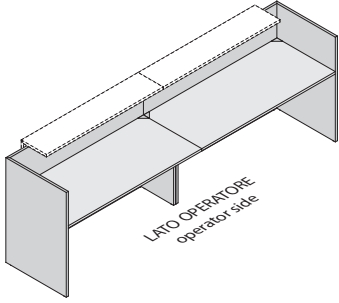
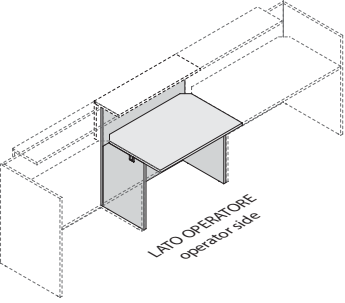
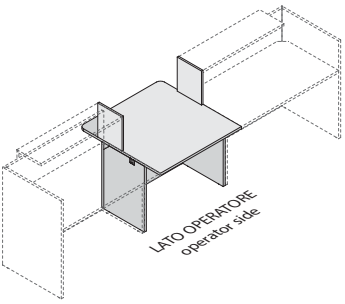
DESCRIZIONE description	L w	CODICE code	KG	M <sup>3</sup>	COLLI	PREZZO price	(*) CODICE FINITURA (*) finish code	
RECEPTION LINEARE SINGOLA <i>single linear reception</i>    L. x p.72,5 x H.105	L.125	<b>116 013 (*)</b>	62	0,178	4	<b>€ 390,00</b>		
	L.145	<b>116 014 (*)</b>	68	0,191	4	<b>€ 419,00</b>		
	L.165	<b>116 019 (*)</b>	79	0,219	4	<b>€ 437,00</b>		
	L.185	<b>116 020 (*)</b>	85	0,235	4	<b>€ 464,00</b>		
	<b>È POSSIBILE UTILIZZARE 1 MENSOLA</b> <i>you can use a shelf</i>							
RECEPTION LINEARE DOPPIA <i>double linear reception</i>    L. x p.72,5 x H.105	L.245	<b>116 022 (*)</b>	117	0,327	8	<b>€ 690,00</b>		
	L.285	<b>116 023 (*)</b>	129	0,361	8	<b>€ 746,00</b>		
	L.325	<b>116 024 (*)</b>	145	0,408	8	<b>€ 800,00</b>		
	L.365	<b>116 025 (*)</b>	159	0,437	8	<b>€ 856,00</b>		
	<b>È POSSIBILE UTILIZZARE 2 MENSOLE</b> <i>you can use two shelf</i>							
MODULO PROLUNGA CENTRALE <i>central module</i>    L.100 x p.72,5 x H.105	L.100	<b>116 027 (*)</b>	49	0,131	4	<b>€ 295,00</b>		
	<b>COMPLETARE SEMPRE CON 1 MENSOLA ART.045</b> <i>to be always complete with 1 shelf art.045</i>							
	<b>VERSIONE MONO-COLORE / single-color version</b>							
	(*)							
	166	NOCE PAVIA	pavia walnut					
	440	BIANCO BR.	br. white					
	844	STONE GREY	stone grey					
	<b>VERSIONE BI-COLORE / double-color version</b>							
	(*)	PIANO	STRUTTURA	top	structure			
	403	ROVERE	BIANCO BR.	oak	br. white			
	404	ROVERE GREY	BIANCO BR.	grey oak	br. white			
	444	STONE GREY	BIANCO BR.	stone grey	br. white			
	466	NOCE PAVIA	BIANCO BR.	pavia walnut	br. white			
	490	WENGE'	BIANCO BR.	wenge	br. white			
503	ROVERE	ANTRACITE	oak	anthracite				
504	ROVERE GREY	ANTRACITE	grey oak	anthracite				
541	BIANCO BR.	ANTRACITE	br. white	anthracite				
544	STONE GREY	ANTRACITE	stone grey	anthracite				
566	NOCE PAVIA	ANTRACITE	pavia walnut	anthracite				
591	WENGE'	ANTRACITE	wenge	anthracite				
803	ROVERE	STONE GREY	oak	stone grey				
804	ROVERE GREY	STONE GREY	grey oak	stone grey				
840	BIANCO BR.	STONE GREY	br. white	stone grey				
866	NOCE PAVIA	STONE GREY	pavia walnut	stone grey				
890	WENGE'	STONE GREY	wenge	stone grey				
MODULO CONVERSAZIONE CENTRALE <i>central conversation module</i>    L.100 x p.100 x H.105	L.100	<b>116 028 (*)</b>	54	0,123	5	<b>€ 326,00</b>		



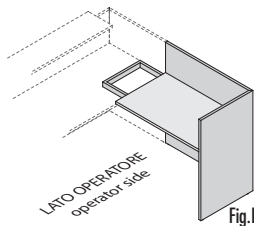

**ALLUNGHI RECEPTION**
**PIANI sp. 25mm**  
 tops thick. 25mm
*extension reception*

DESCRIZIONE <i>description</i>	L w	CODICE <i>code</i>	KG	M <sup>3</sup>	COLLI	PREZZO <i>price</i>	(*) CODICE FINITURA <i>(*) finish code</i>					
ALLUNGO RECEPTION DX <i>right extension reception</i>   LATO OPERATORE <i>operator side</i> Fig.DX/right  L.102,5 x p.62,5 x H.105	DX <i>right</i>	L.102,5	116 <b>038</b> (*)	49	0,167	4	€ 314,00	VERSIONE MONO-COLORE / <i>single-color version</i>				
								(*)				
								166	NOCE PAVIA	pavia walnut		
								440	BIANCO BR.	br. white		
								844	STONE GREY	stone grey		
								VERSIONE BI-COLORE / <i>double-color version</i>				
								(*)	PIANO	STRUTTURA	top	structure
								403	ROVERE	BIANCO BR.	oak	br. white
								404	ROVERE GREY	BIANCO BR.	grey oak	br. white
								444	STONE GREY	BIANCO BR.	stone grey	br. white
466	NOCE PAVIA	BIANCO BR.	pavia walnut	br. white								
490	WENGE'	BIANCO BR.	wenge	br. white								
503	ROVERE	ANTRACITE	oak	anthracite								
504	ROVERE GREY	ANTRACITE	grey oak	anthracite								
541	BIANCO BR.	ANTRACITE	br. white	anthracite								
544	STONE GREY	ANTRACITE	stone grey	anthracite								
566	NOCE PAVIA	ANTRACITE	pavia walnut	anthracite								
591	WENGE'	ANTRACITE	wenge	anthracite								
803	ROVERE	STONE GREY	oak	stone grey								
804	ROVERE GREY	STONE GREY	grey oak	stone grey								
840	BIANCO BR.	STONE GREY	br. white	stone grey								
866	NOCE PAVIA	STONE GREY	pavia walnut	stone grey								
890	WENGE'	STONE GREY	wenge	stone grey								

**MENSOLE PER RECEPTION LINEARI e KIT LED***shelves for linear reception ad led kit*

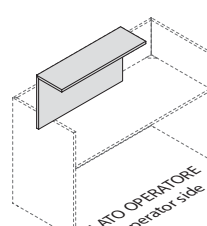
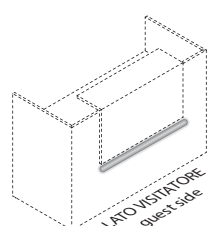
DESCRIZIONE <i>description</i>	L	CODICE <i>code</i>	KG	M <sup>3</sup>	COLLI	PREZZO <i>price</i>	(*) CODICE FINITURA <i>(*) finish code</i>				
MENSOLE PER RECEPTION LINEARI <i>shelf for linear reception</i>   LATO OPERATORE <i>operator side</i>  L. x p.30 x H.50		L.100	116 <b>045</b> (*)	13	0,044	2	€ 161,00	(*) MENSOLE <i>shelf</i> 166 NOCE PAVIA pavia walnut 440 BIANCO BR. br. white 551 ANTRACITE anthracite 704 ROVERE GREY grey oak 733 ROVERE oak 844 STONE GREY stone grey 900 WENGE' wenge			
		L.120	116 <b>046</b> (*)	15	0,052	2	€ 177,00				
		L.140	116 <b>047</b> (*)	17	0,059	2	€ 192,00				
		L.160	116 <b>048</b> (*)	17	0,067	2	€ 207,00				
		PROSPETTO INFORMATIVO <i>information sheet</i> RECEPTION → UTILIZZA MENSOLE <i>use shelves</i> ART.013 + Q.ty 1 x ART.045 ART.014 + Q.ty 1 x ART.045 ART.019 + Q.ty 1 x ART.046 ART.020 + Q.ty 1 x ART.047 ART.022 + Q.ty 2 x ART.045 ART.023 + Q.ty 2 x ART.046 ART.024 + Q.ty 2 x ART.047 ART.025 + Q.ty 2 x ART.048 ART.027 + Q.ty 1 x ART.045									
		KIT LED INFERIORE PER MENSOLE <i>lower led kit for shelves</i>   LATO VESTITORE <i>guest side</i>  L. <i>width</i>		L.100	116 <b>060</b> (*)	1	0,009		1	€ 144,00	(*) LED <i>led</i> 999 NEUTRO neuter
				L.120	116 <b>061</b> (*)	1	0,009		1	€ 155,00	
				L.140	116 <b>062</b> (*)	1,2	0,010		1	€ 165,00	
				L.160	116 <b>063</b> (*)	1,2	0,010		1	€ 175,00	

**ESEMPI DI COMPONENTABILITA'**

*examples of compositions*

RECEPTION LINEARE SINGOLA  
single linear reception

**ART.013+045**

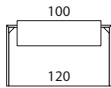

**ART.014+045**

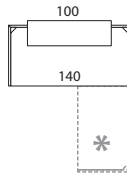

**ART.019+046**

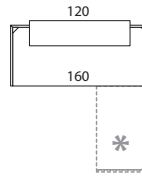

**ART.020+047**

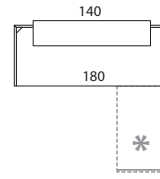

- VISTE IN PIANTA -  
- Top view -

\* = POSSIBILITA' DI UTILIZZO ALLUNGO RECEPTION DX O SX  
= Possibility to use the right or left extension reception

RECEPTION LINEARE DOPPIA  
double linear reception

**1 ART.022 + 2 ART.045**

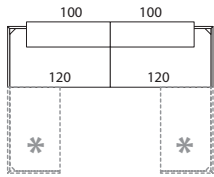

**1 ART.023 + 2 ART.046**

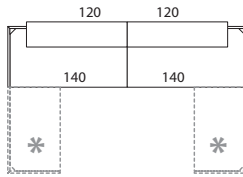

**1 ART.024 + 2 ART.047**

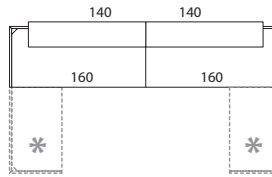

**1 ART.025 + 2 ART.048**

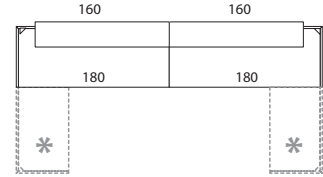

RECEPTION LINEARE CON MODULO PROLUNGA CENTRALE  
linear reception with central module

**1 ART.022 + 1 ART.027 + 3 ART.045**

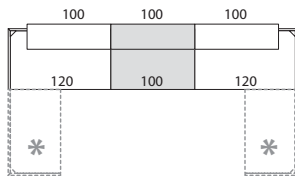

**1 ART.023 + 1 ART.027 + 1 ART.045 + 2 ART.046**

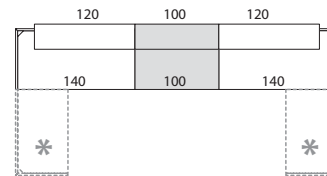

**1 ART.024 + 1 ART.027 + 1 ART.045 + 2 ART.047**

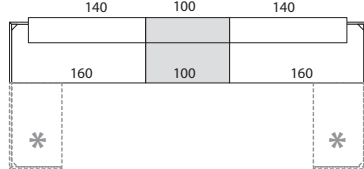

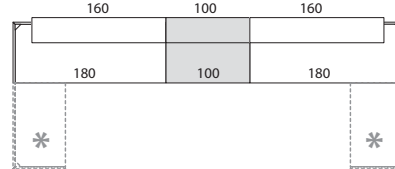

**1 ART.025 + 1 ART.027 + 1 ART.045 + 2 ART.048**

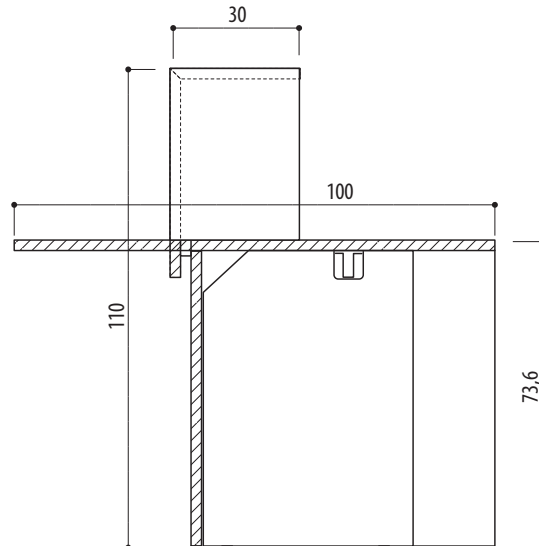
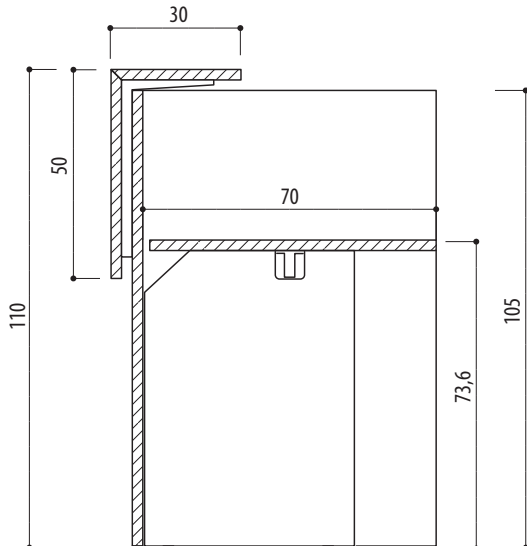

- SEZIONE VERTICALE -  
- Vertical section -

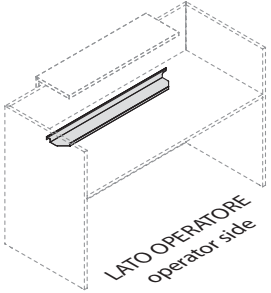
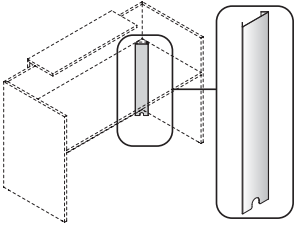
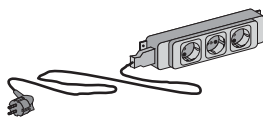
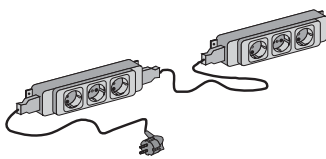

VASCHETTE PASSACAVI e KIT ELETTRIFICAZIONE										
cable-trays and electrification kit										
DESCRIZIONE description	L w	L w	CODICE code	KG	M <sup>3</sup>	COLLI	PREZZO price	(*) CODICE FINITURA (*) finish code		
<p>VASCHETTE PASSACAVI cable-trays</p>  <p>L. x p.12 x H.6</p>	<p>L. PORTACAVI w cable cannel</p> <p>UTILIZZARE SU RECEPTION use on reception</p>									
	L.79	L.100	148 <b>504</b> (*)	1,5	0,014	1	€ 30,00			
	L.89	L.120	148 <b>505</b> (*)	1,8	0,014	1	€ 31,00			
	L.109	L.140	148 <b>506</b> (*)	1,9	0,021	1	€ 34,00			
	L.129	L.160	148 <b>507</b> (*)	2,2	0,021	1	€ 37,00			
	L.149	L.180	148 <b>508</b> (*)	2,7	0,021	1	€ 41,00			
								(*)		
							440	BIANCO	white	
							551	ANTRACITE	anthracite	
							844	STONE GREY	stone grey	
<p>SALITA CAVI PER RECEPTION rising cable tray for reception</p>  <p>L.7 x p.7 x H.65</p>			148 <b>309</b> (*)	2	0,001	1	€ 25,00			
<p>KIT ELETTTRIF. SINGOLO CON PRESE SCHUKO E CAVO DI ALIMENTAZIONE DI MT. 2,00 single electrif. kit with SCHUKO sockets and power cable w 2 lmt.</p> 			175 <b>899</b> (*)	1	0,006	1	€ 86,00			
NON DISPONIBILE PER MERCATO U.S.A. not available for US market										
<p>KIT ELETTTRIF. DOPPIO CON PRESE SCHUKO E CAVO DI ALIMENTAZIONE DI MT. 2,00 double electrif. kit with SCHUKO sockets and power cable w 2 lmt.</p> 			175 <b>900</b> (*)	1	0,006	1	€ 160,00			
NON DISPONIBILE PER MERCATO U.S.A. not available for US market										
								(*)		
								500	NERO	black
<p>KIT PROLUNGA DI MT. 2,00 CON PRESA ENTRATA/1 USCITA extension kit of w 2 lmt. with an input-and-out-put-plug</p> 			175 <b>901</b> (*)	0,5	0,002	1	€ 30,00			
NON DISPONIBILE PER MERCATO U.S.A. not available for US market										

POINT  
reception

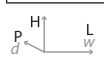

# POINT

## reception

### DESCRIZIONE TECNICA

#### RECEPTION

##### PIANI DI LAVORO

Sono realizzati in pannelli di particelle di legno sp. mm 25 nobilitati in melaminico e bordati perimetralmente in ABS mm 2 in tinta con la superficie.

I piani di lavoro sono disponibili nei colori: ROVERE 03, ROVERE GREY 04, NOCE PAVIA 06, STONE GREY 44, WENGE 45, BIANCO BR. 69.

I piani di lavoro sono forniti con trave orizzontale di sostegno realizzata in acciaio pressopiegato a sezione rettangolare 50 x 30 x sp. 1,5 verniciata a polveri epossidiche: BIANCO, ANTRACITE, STONE GREY.

##### MENSOLE

Sono realizzati in pannelli di particelle di legno sp. mm 25 nobilitati in melaminico e bordati perimetralmente in ABS mm 2 in tinta con la superficie.

Le mensole ,con taglio a 45° gradi e accoppiate fra loro, sono dotate di staffe metalliche per l'ancoraggio ai pannelli verticali.

Sono disponibili nei colori: ROVERE 03, ROVERE GREY 04, NOCE PAVIA 06, STONE GREY 44, WENGE 45, ANTRACITE 55, BIANCO BR. 69

Sono predisposte per l'alloggiamento di illuminazione a led, fornito come kit a parte.

##### PANNELLI VERTICALI E FIANCHI SOTTOPIANO

Sono realizzati in pannelli di particelle di legno sp. mm 25 nobilitati in melaminico e bordati perimetralmente in ABS mm 2 in tinta con la superficie.

Disponibili nei colori: NOCE PAVIA 06, STONE GREY 44, ANTRACITE 55, BIANCO BR. 69.

Nella parte a contatto con il pavimento sono inseriti i piedini livellatori.

Sono forniti con piastrini in plastica di disegno esclusivo che hanno la funzione di sostegno in caso di collegamento con i piani.

##### CANALE PORTACAVI

Optional in lamiera sp. mm 1 verniciata a polveri epossidiche: BIANCO, ANTRACITE, STONE GREY.

Consente l'alloggiamento di kit di elettrificazione marchiati "GS" completi di prese SCHUCO e la raccolta dei cavi in eccesso. Il montaggio avviene a sospensione sui piastrini reggi-piano.

##### IMBALLO

Tutti i componenti sono forniti smontati ed imballati con involucro pieghevole in cartone triplo, listelli di protezione perimetrale e per i riempimenti ove occorre. Gli angoli sono protetti , ove occorre, con parasigoli anti-urto. La chiusura dell'imballo avviene mediante nastro adesivo e reggetta in nylon termosaldato.

### TECHNICAL DESCRIPTION

#### WORK TOPS

The work tops are made in particleboards, thickness 25 mm, with melamine facing and edge-finishing in 2 mm ABS matching the main shade, available in the following colours: OAK 03, GREY OAK 04, PAVIA WALNUT 06, STONE GREY 44, WENGE 45, BR. WHITE 69.

Worktops are supplied with horizontal beam of support made in press-folded sheet metal 50 x 30 x thickness 1,5 painted with epoxy powder, available in the following colours: WHITE, ANTHRACITE, STONE GREY.

#### SHELVES

The shelves are made in particleboards, thickness 25 mm, with melamine facing and edge-finishing in 2 mm ABS matching the main shade, available in the following colours: OAK 03, GREY OAK 04, PAVIA WALNUT 06, STONE GREY 44, WENGE 45, ANTHRACITE 55, BR. WHITE 69.

The shelves ,with a 45 ° cut and coupled together, are supplied with metal stirrups for fixing to vertical panels.

They are prepared for the inclusion of LED lighting, supplied as a separate kit.

#### VERTICAL PANELS AND UNDERTOP SIDE PANELS

The panels are made in particleboards, thickness 25 mm, with melamine facing and edge-finishing in 2 mm ABS matching the main shade, available in the following colours: PAVIA WALNUT 06, STONE GREY 44, ANTHRACITE 55, BR. WHITE 69.

Levelling feet are fitted on the part in contact with the floor.

The fixing to the work tops is permitted by plastic elements of exclusive design which also provide a support function if connected to work tops.

#### CABLE CHANNEL:

Optional, in sheet metal, thickness 1 mm, powder-painted in epoxy resin, for housing the "GS" electrification kit complete with SCHUCO sockets and hiding excess cable lengths. Assembly by suspension on the plastic elements. Available in the following colours: WHITE, ANTHRACITE, STONE GREY.

#### PACKAGING

All the components are disassembled and packed when supplied, and have paper triple type folding packaging, fillets for the perimetrical protection and for the fillings up, where needed . The corners are protected, where needed, through shock resistant edges protector. The packing closure occurs through sticky tape and welded nylon strap.

**INDICE DEI CODICI**  
codes index

\* = INDICARE IL CODICE FINITURA  
= complete with finish code

INDICE DEI CODICI / codes index  
Mod.POINT

CODICE code	DESCRIZIONE description	PAG. page	PREZZO price
116 <b>013</b> *	RECEPTION LINEARE SINGOLA L.125 single linear reception w 125 cms	4	€ 390,00
116 <b>014</b> *	RECEPTION LINEARE SINGOLA L.145 single linear reception w 145 cms	4	€ 419,00
116 <b>019</b> *	RECEPTION LINEARE SINGOLA L.165 single linear reception w 165 cms	4	€ 437,00
116 <b>020</b> *	RECEPTION LINEARE SINGOLA L.185 single linear reception w 185 cms	4	€ 464,00
116 <b>022</b> *	RECEPTION LINEARE DOPPIA L.245 single linear reception w 245 cms	4	€ 690,00
116 <b>023</b> *	RECEPTION LINEARE DOPPIA L.285 single linear reception w 285 cms	4	€ 746,00
116 <b>024</b> *	RECEPTION LINEARE DOPPIA L.325 single linear reception w 325 cms	4	€ 800,00
116 <b>025</b> *	RECEPTION LINEARE DOPPIA L.365 single linear reception w 365 cms	4	€ 856,00
116 <b>027</b> *	MODULO PROLUNGA CENTRALE L.100 central module w 100 cms	4	€ 295,00
116 <b>028</b> *	MODULO CONVERSAZIONE CENTRALE L.100 central conversation module w 100 cms	4	€ 326,00
116 <b>038</b> *	ALLUNGO RECEPTION DX right extension reception	5	€ 314,00
116 <b>039</b> *	ALLUNGO RECEPTION SX left extension reception	5	€ 314,00
116 <b>045</b> *	MENSOLA L.100 shelf w 100 cms	5	€ 161,00
116 <b>046</b> *	MENSOLA L.120 shelf w 120 cms	5	€ 177,00
116 <b>047</b> *	MENSOLA L.140 shelf w 140 cms	5	€ 192,00
116 <b>048</b> *	MENSOLA L.160 shelf w 160 cms	5	€ 207,00
116 <b>060</b> *	KIT LED PER MENSOLA L.100 led kit for shelf w 100 cms	5	€ 144,00
116 <b>061</b> *	KIT LED PER MENSOLA L.120 led kit for shelf w 120 cms	5	€ 155,00
116 <b>062</b> *	KIT LED PER MENSOLA L.140 led kit for shelf w 140 cms	5	€ 165,00
116 <b>063</b> *	KIT LED PER MENSOLA L.160 led kit for shelf w 160 cms	5	€ 175,00
148 <b>309</b> *	SALITA CAVI PER RECEPTION rising cable tray for reception	7	€ 25,00
148 <b>504</b> *	VASCHETTA PASSACAVI L.79 cable-tray w 79 cms	7	€ 30,00
148 <b>505</b> *	VASCHETTA PASSACAVI L.89 cable-tray w 89 cms	7	€ 31,00
148 <b>506</b> *	VASCHETTA PASSACAVI L.109 cable-tray w 109 cms	7	€ 34,00
148 <b>507</b> *	VASCHETTA PASSACAVI L.129 cable-tray w 129 cms	7	€ 37,00
148 <b>508</b> *	VASCHETTA PASSACAVI L.149 cable-tray w 149 cms	7	€ 41,00
175 <b>899</b> *	KIT ELETTRIF. SINGOLO CON PRESE SCHUKO E CAVO DI ALIMENTAZIONE DI MT 2,00 single electrification kit with SCHUKO sockets and power cable of w 200 cms	7	€ 86,00
175 <b>900</b> *	KIT ELETTRIF. DOPPIO CON PRESE SCHUKO E CAVO DI ALIMENTAZIONE DI MT 2,00 double electrification kit with SCHUKO sockets and power cable of w 200 cms	7	€ 160,00
175 <b>901</b> *	KIT PROLUNGA DI MT 2,00 CON 1 PRESA ENTRATA / 1 USCITA extension kit of w 200 cms with an input-and-out-put-plug	7	€ 30,00

POINT  
reception





**LISTINO** 2018  
PRICE LIST

# NICE reception

Design: STUDIO SI      Engineering: C.S.R. LAS MOBILI

NICE  
reception



Certificato 04/16

### IMPORTANTE / it's very important

SULL'ORDINE INDICARE SEMPRE IL CODICE COMPLETO A 9 CIFRE  
always indicate on the order the complete 9-digit code

ESEMPIO: PER ORDINARE 1 MENSOLA ART.339 BIANCO BR. INDICARE IL CODICE =  
example: to order 1 SHELF ART.339 BR.WHITE indicate the code =

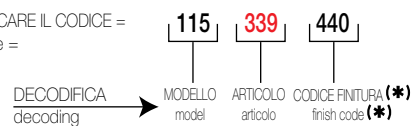

In vigore dal:  
Valid from:  
01/01/2018

Valido fino a nuova emissione  
Valid until new emission

## SOMMARIO / summary

<b>CARTELLA COLORI</b> .....	<b>3</b>
<i>colours samples card</i>	
<b>COMPONENTI</b> .....	<b>4</b>
<i>components</i>	
<b>MODULI BASE LINEARI</b> .....	<b>7</b>
<i>linear base modules</i>	
<b>MODULI CONVERSAZIONE</b> .....	<b>7</b>
<i>conversation modules</i>	
<b>MODULI BASE ANGOLARI</b> .....	<b>8</b>
<i>angular base modules</i>	
<b>FASCE SUPERIORI VETRO oppure POLICARBONATO CON LED</b> .....	<b>9</b>
<i>upper glass bands or polycarbonate with led</i>	
<b>KIT ACCENSIONE LED CENTRALIZZATA</b> .....	<b>10</b>
<i>power centralized kit</i>	
<b>ELEMENTI DI SUPPORTO</b> .....	<b>11</b>
<i>supporting elements</i>	
<b>TOP PER STORAGE</b> .....	<b>13</b>
<i>top for storage</i>	
<b>MENSOLE</b> .....	<b>14</b>
<i>shelves</i>	
<b>DIMENSIONI</b> .....	<b>15</b>
<i>dimensions</i>	
<b>CANALI PORTA-CAVI E KIT PER ELETRIFICAZIONE</b> .....	<b>16</b>
<i>cable channels and electrification kit</i>	
<b>CASSETTIERE SU RUOTE</b> .....	<b>17</b>
<i>pedestals on wheels</i>	
<b>MOBILI BASSI</b> .....	<b>17</b>
<i>low cabinets</i>	
<b>MOBILI MEDI</b> .....	<b>17</b>
<i>medium cabinets</i>	
<b>MOBILI ALTI</b> .....	<b>18</b>
<i>high cabinets</i>	
<b>TOPS + COPPIA DI FIANCHI FINALI</b> .....	<b>18</b>
<i>tops + set of 2 final side panels</i>	
<b>ESEMPI COMPOSIZIONI</b> .....	<b>19</b>
<i>examples compositions</i>	
<b>DESCRIZIONE TECNICA</b> .....	<b>20</b>
<b>TECHNICAL DESCRIPTION</b> .....	<b>22</b>
<b>INDICE DEI CODICI</b> .....	<b>24</b>
<i>codes index</i>	



**CARTELLA COLORI**  
colours samples card

**LEGNI | WOOD**

**STANDARD**



**COD. 29**   
**NOCE ITALIA** | ITALY WALNUT

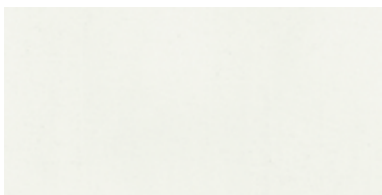

**COD. 69**   
**BIANCO BR.** | BR. WHITE



**COD. 85**   
**LARICE SABBIA** | SAND LARCH



**COD. 86**   
**LARICE MOKA** | MOKA LARCH

**NATUR MAT**

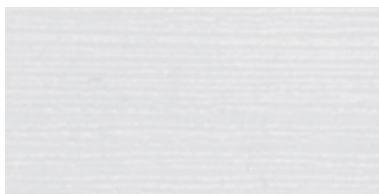

**COD. 15**   
**BIANCO NATUR MAT** | NATUR MAT WHITE



**COD. 16**   
**NERO NATUR MAT** | NATUR MAT BLACK

**HIGH GLOSS**



**COD. 48**   
**BIANCO HIGH GLOSS** | HIGH GLOSS WHITE



**COD. 49**   
**NERO HIGH GLOSS** | HIGH GLOSS BLACK



**COD. 50**   
**ZEBRANO HIGH GLOSS** | HIGH GLOSS ZEBRAWOOD

**STANDARD**

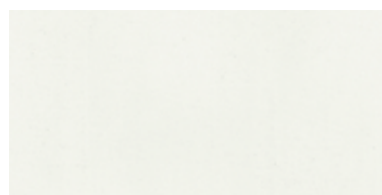

**COD. 69**   
**BIANCO BR.** | BR. WHITE

**CARCASSE CASSETTIERE SU RUOTE,  
MOBILI BASSI ,MEDI E E ALTI**

structure of pedestal on wheels,  
low, medium and high cabinets

**VETRI | GLASS**



**COD. 10**  
**NERO** | BLACK

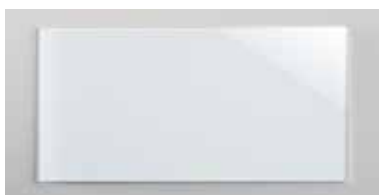

**COD. 78**  
**BIANCO EXTRA** | EXTRA WHITE



**COD. 99**  
**BIANCO SATINATO** | SATINED WHITE

											COLORI VETRI PER MENSOLE O FASCE <i>glass colours for shelves or bands</i>		
		STANDARD				NATUR MAT		HIGH GLOSS			RETROLACCATI <i>rearlacquered</i>		
		BIANCO BR. <i>br. white</i>	LARICE SABBIA <i>sand larch</i>	LARICE MOKA <i>moka larch</i>	NOCE ITALIA <i>italy walnut</i>	BIANCO NATUR MAT <i>natur mat white</i>	NERO NATUR MAT <i>natur mat black</i>	BIANCO HIGH GLOSS <i>high gloss white</i>	NERO HIGH GLOSS <i>high gloss black</i>	ZEBRANO HIGH GLOSS <i>high gloss zebra wood</i>	NERO <i>black</i>	BIANCO EXTRA <i>extra white</i>	BIANCO SATINATO <i>satined white</i>
COMPONENTI <i>components</i>													
MODULI BANCONE LINEARI O ANGOLARI <i>linear or angular counter desks</i>	PIANO DI LAVORO <i>desk top</i>	◇	◇	◇	◇	◇	◇	-----	-----	-----	-----	-----	-----
	FASCE FRONTALI <i>front bands</i>	-----	◇	◇	◇	-----	-----	◇	◇	◇	◇	◇	◇
MODULI CONVERSAZIONE <i>conversation modules</i>	PIANO DI LAVORO <i>desk top</i>	◇	◇	◇	◇	◇	◇	-----	-----	-----	-----	-----	-----
	FASCE FRONTALI <i>front bands</i>	-----	◇	◇	◇	-----	-----	◇	◇	◇	-----	-----	-----
MENSOLE <i>shelves</i>		◇	◇	◇	◇	◇	◇	-----	-----	-----	◇	◇	◇
FIANCHI TERMINALI O CENTRALI <i>central or end panels</i>		◇	-----	-----	◇	◇	◇	-----	-----	◇	-----	-----	-----
STORAGE <i>storage</i>	TOP	◇	◇	◇	◇	◇	◇	-----	-----	◇	◇	◇	-----
	STRUTTURA <i>structure</i>	◇	-----	-----	-----	◇	◇	-----	-----	◇	-----	-----	-----
CASSETTIERE SU RUOTE <i>pedestal on wheels</i>	TOP, FIANCHI FINALI, SCHIENA, FRONTALI <i>top, finalside panels, back panel, fronts</i>	◇	◇	◇	◇	◇	◇	-----	-----	◇	-----	-----	-----
	STRUTTURA <i>structure</i>	◇	-----	-----	-----	-----	-----	-----	-----	-----	-----	-----	-----
MOBILI BASSI, MEDI E ALTI <i>low, medium and high cabinets</i>	ANTE, TOP E FIANCHI FINALI <i>doors, top and final side panels</i>	◇	◇	◇	◇	◇	◇	-----	-----	◇	-----	-----	-----
	STRUTTURA <i>structure</i>	◇	-----	-----	-----	-----	-----	-----	-----	-----	-----	-----	-----

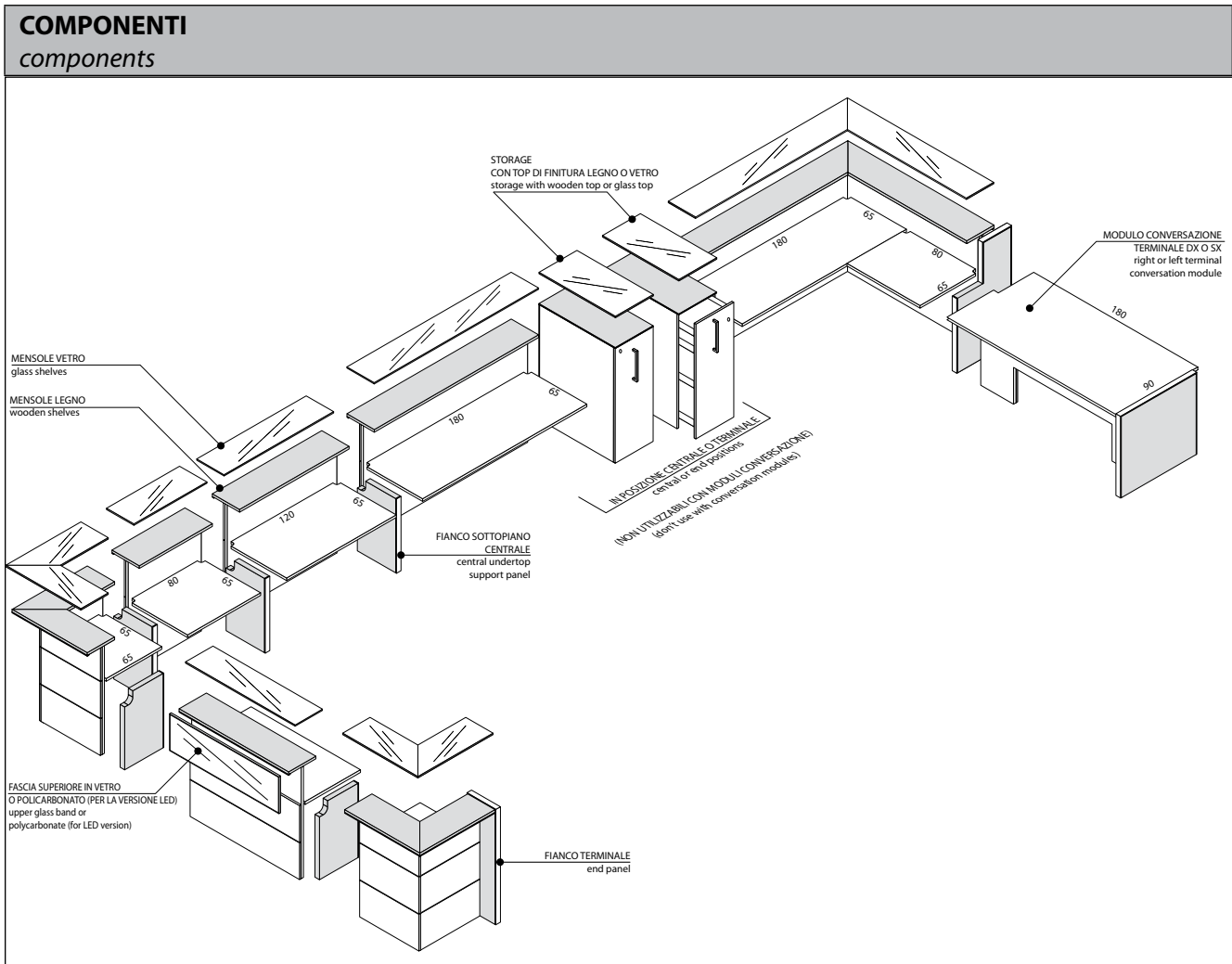

PER REALIZZARE UNA COMPOSIZIONE OCCORRE UTILIZZARE 1 O PIU' COMPONENTI DI TUTTE LE TIPOLOGIE SOTTO RIPORTATE E NELLA SEQUENZA INDICATA:

for assemble a composition use 1 or more components as described here below (any kind) in the following phases:

- A** moduli base (lineari o angolari)
- A1** (eventuali fasce superiori in vetro o policarbonato)
- B** 1 elemento di supporto centrale per ogni collegamento fra moduli
- C** 1 elemento di supporto terminale per ogni lato finale del bancone
- D** mensole legno o vetro
- E** (eventuale kit accensione centralizzata per lampade a led)

- A** base modules (linear or angular)
- A1** (if needed, upper glass or polycarbonate bands)
- B** 1 central supporting element for joint between modules
- C** 1 terminal supporting element for each reception's end side
- D** wooden or glass shelves
- E** (if needed, power centralized kit for led lamps)

<b>A</b>	<b>A1</b>	<b>B</b>	<b>C</b>	<b>D</b>	<b>E</b>
MODULI BASE LINEARI O ANGOLARI linear or angular base module	FASCIA SUPERIORE VETRO O POLICARBONATO upper glass or polycarbonate bands	ELEMENTI DI SUPPORTO CENTRALI central supporting elements	ELEMENTI DI SUPPORTO TERMINALI terminal supporting elements	MENSOLE LEGNO O VETRO wooden or glass shelves	KIT ACCENSIONE CENTRALIZZATA PER LAMPADE A LED power centralized kit for led lamps
	—		 idem		—
			 idem		<b>VEDI PAG.10</b> please see page 10
<b>TERMINALE DX O SX</b> right or left terminal 	—			—	—
	—		 idem		—
			 idem		<b>VEDI PAG.10</b> please see page 10
	—	 idem	 idem		—
		 idem	 idem		<b>VEDI PAG.10</b> please see page 10

ABBINAMENTI COLORI / matching colours						
(*)	PIANO	PANNELLO INTERNO	FASCE	top	internal panel	bands
419	NOCE ITALIA	BIANCO BR.	NOCE ITALIA	italy walnut	br. white	italy walnut
519	NOCE ITALIA	NERO	NOCE ITALIA	italywalnut	black	italy walnut
445	BIANCO NATUR MAT	BIANCO BR.	NERO H.G.	natur mat white	br. white	h.g. black
448	BIANCO NATUR MAT	BIANCO BR.	BIANCO H.G.	natur mat white	br. white	h.g. white
446	BIANCO BR.	BIANCO BR.	NERO H.G.	br. white	br. white	h.g. black
447	BIANCO BR.	BIANCO BR.	BIANCO H.G.	br. white	br. white	h.g. white
450	BIANCO BR.	BIANCO BR.	ZEBRANO H.G.	br. white	br. white	h.g. zebrawood
470	BIANCO BR.	BIANCO BR.	LARICE MOKA	br. white	br. white	moka larch
480	BIANCO BR.	BIANCO BR.	LARICE SABBIA	br. white	br. white	sand larch
549	NERO NATUR MAT	NERO	NERO H.G.	natur mat black	black	h.g. black
550	NERO NATUR MAT	NERO	ZEBRANO H.G.	natur mat black	black	h.g. zebrawood
700	LARICE MOKA	NERO	LARICE MOKA	moka larch	black	moka larch
740	LARICE MOKA	BIANCO BR.	LARICE MOKA	moka larch	br. white	moka larch
800	LARICE SABBIA	BIANCO BR.	LARICE SABBIA	sand larch	br. white	sand larch

ABBINAMENTI COLORI SU MODULI BASE LINEARI O ANGOLARI  
matching colours for linear or angular base modules

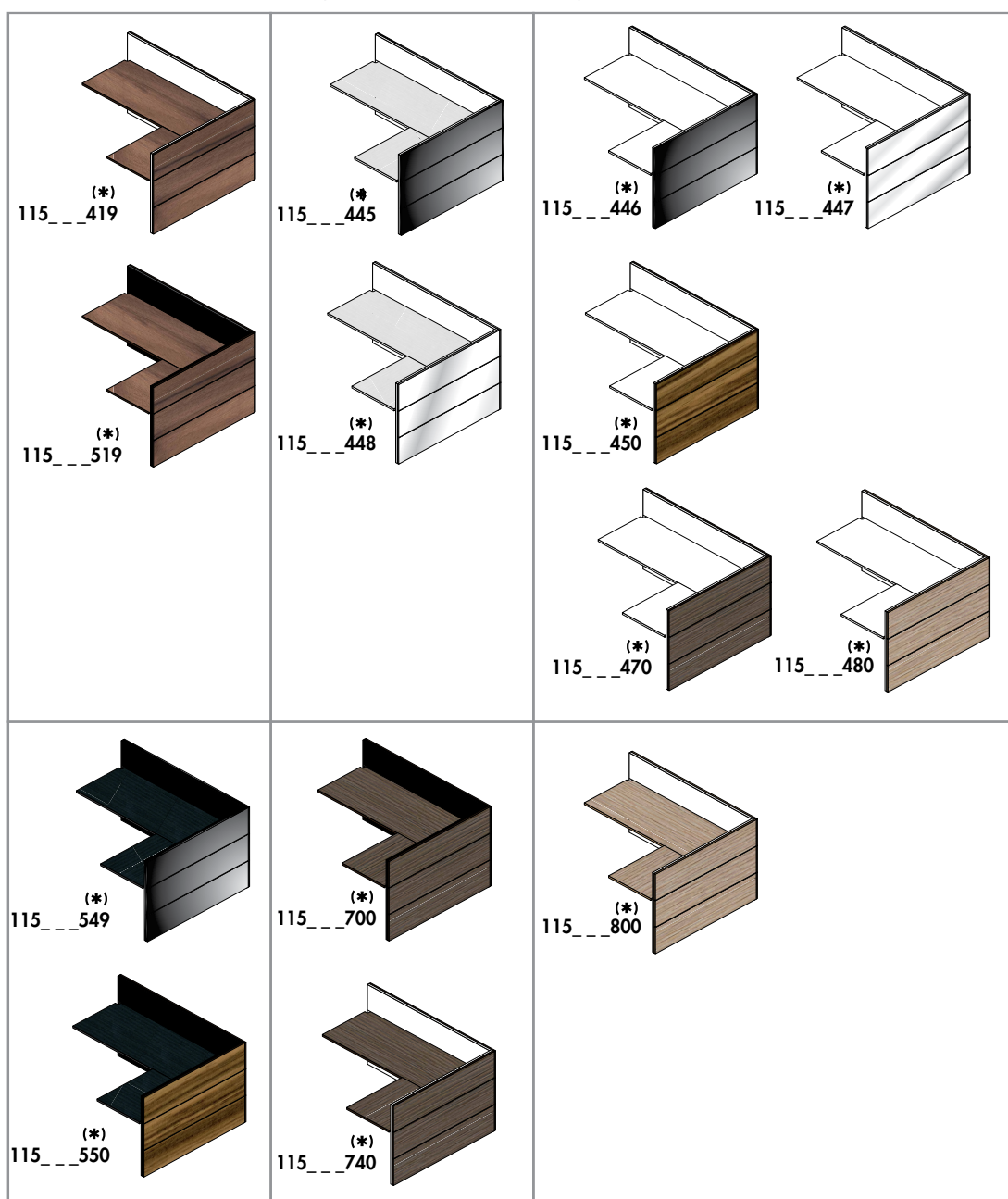



MODULI BASE LINEARI linear base modules							(*) CODICE FINITURA (*) finish code							
DESCRIZIONE description	L w	CODICE code	KG	M <sup>3</sup>	COLLI	PREZZO price								
MODULO BASE LINEARE 3 FASCE LEGNO linear base module with 3 wooden bands  	L.80	115 <b>330</b> (*)	44	0,108	4	€ 347,00								
	L.120	115 <b>331</b> (*)	61	0,153	4	€ 446,00								
	L.180	115 <b>332</b> (*)	89	0,234	4	€ 672,00								
								(*)	PIANO	PANNELLO INTERNO	FASCE	top	internal panel	bands
							419	NOCE ITALIA	BIANCO BR. NOCE ITALIA		italy walnut	br. white	italy walnut	
							519	NOCE ITALIA	NERO NOCE ITALIA		italy walnut	black	italy walnut	
							445	BIANCO NAT. MAT	BIANCO BR. NERO H.G.		natur mat white	br. white	h.g. black	
							448	BIANCO NAT. MAT	BIANCO BR. BIANCO H.G.		natur mat white	br. white	h.g. white	
							446	BIANCO BR.	BIANCO BR. NERO H.G.		br. white	br. white	h.g. black	
							447	BIANCO BR.	BIANCO BR. BIANCO H.G.		br. white	br. white	h.g. white	
							450	BIANCO BR.	BIANCO BR. ZEBRANO H.G.		br. white	br. white	h.g. zebra wood	
							470	BIANCO BR.	BIANCO BR. LARICE MOKA		br. white	br. white	moka larch	
							480	BIANCO BR.	BIANCO BR. LARICE SABBIA		br. white	br. white	sand larch	
							549	NERO NAT. MAT	NERO NERO H.G.		natur mat black	black	h.g. black	
							550	NERO NAT. MAT	NERO ZEBRANO H.G.		natur mat black	black	h.g. zebra wood	
							700	LARICE MOKA	NERO LARICE MOKA		moka larch	black	moka larch	
							740	LARICE MOKA	BIANCO BR. LARICE MOKA		moka larch	br. white	moka larch	
							800	LARICE SABBIA	BIANCO BR. LARICE SABBIA		sand larch	br. white	sand larch	
MODULO BASE LINEARE 2 FASCE LEGNO linear base module with 2 wooden bands  	L.80	115 <b>335</b> (*)	40	0,108	4	€ 313,00								
	L.120	115 <b>336</b> (*)	55	0,153	4	€ 396,00								
	L.180	115 <b>337</b> (*)	79	0,234	4	€ 597,00								
	COMPLETARE SEMPRE CON 1 FASCIA SUPERIORE IN VETRO ART.347-348-349 oppure POLICARBONATO CON LED ART.351-352-353 to be always complete with 1 upper glass band art.347-348-349 or polycarbonate with led art.351-352-353							<b>A1</b>						

**MODULI CONVERSAZIONE**  
conversation modules





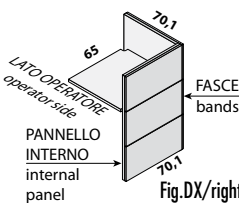
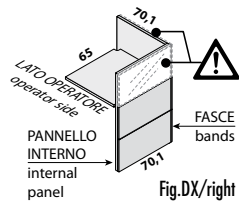
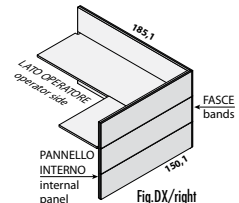
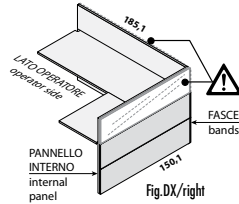

MODULO CONVERSAZIONE TERMINALE DX O SX right or left terminal conversation module							(*) CODICE FINITURA (*) finish code							
DESCRIZIONE description	L w	CODICE code	KG	M <sup>3</sup>	COLLI	PREZZO price								
MODULO CONVERSAZIONE TERMINALE DX O SX right or left terminal conversation module  	L.180	115 <b>367</b> (*)	75	0,207	4	€ 609,00								
	L.180	115 <b>368</b> (*)	75	0,207	4	€ 609,00								
	UTILIZZARE SEMPRE 1 FIANCONE CENTRALE SAGOMATO ART.439+1 FIANCO TERMINALE DX O SX ART.440-441 always use 1 shaped central panel art.439 + 1 right or left terminal panel art.440-441													
								(*)	PIANO	PANNELLO INTERNO	FASCE	top	internal panel	bands
							419	NOCE ITALIA	BIANCO BR. NOCE ITALIA		italy walnut	br. white	italy walnut	
							519	NOCE ITALIA	NERO NOCE ITALIA		italy walnut	black	italy walnut	
							445	BIANCO NAT. MAT	BIANCO BR. NERO H.G.		natur mat white	br. white	h.g. black	
							448	BIANCO NAT. MAT	BIANCO BR. BIANCO H.G.		natur mat white	br. white	h.g. white	
							446	BIANCO BR.	BIANCO BR. NERO H.G.		br. white	br. white	h.g. black	
							447	BIANCO BR.	BIANCO BR. BIANCO H.G.		br. white	br. white	h.g. white	
							450	BIANCO BR.	BIANCO BR. ZEBRANO H.G.		br. white	br. white	h.g. zebra wood	
							470	BIANCO BR.	BIANCO BR. LARICE MOKA		br. white	br. white	moka larch	
							480	BIANCO BR.	BIANCO BR. LARICE SABBIA		br. white	br. white	sand larch	
							549	NERO NAT. MAT	NERO NERO H.G.		natur mat black	black	h.g. black	
							550	NERO NAT. MAT	NERO ZEBRANO H.G.		natur mat black	black	h.g. zebra wood	
							700	LARICE MOKA	NERO LARICE MOKA		moka larch	black	moka larch	
							740	LARICE MOKA	BIANCO BR. LARICE MOKA		moka larch	br. white	moka larch	
							800	LARICE SABBIA	BIANCO BR. LARICE SABBIA		sand larch	br. white	sand larch	

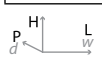
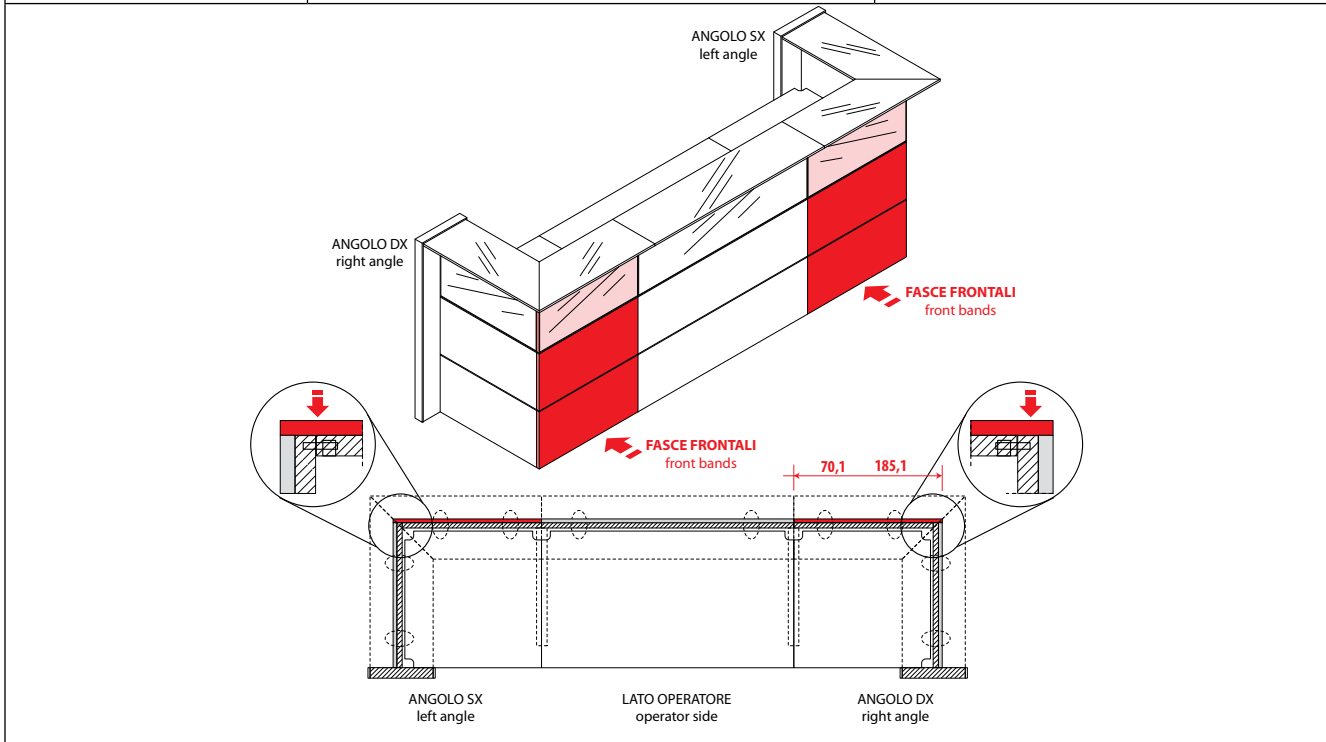
NICE  
reception

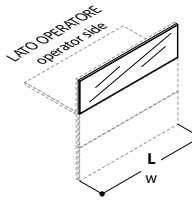
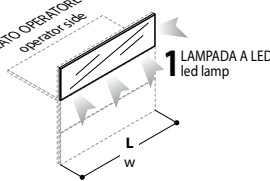

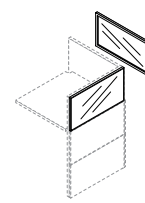
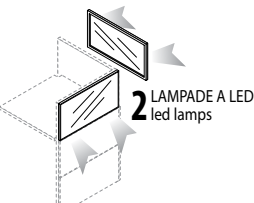
<b>MODULI BASE ANGOLARI</b> <i>angular base modules</i>													
DESCRIZIONE <i>description</i>	L <i>w</i>	CODICE <i>code</i>	KG	M <sup>3</sup>	COLLI	PREZZO <i>price</i>	(*) CODICE FINITURA <i>(*) finish code</i>						
MODULO BASE ANGOLARE 3 FASCE LEGNO <i>angular base module with 3 wooden bands</i>   L.70,1 x p.70,1 x H.106,5	DX <i>right</i>	115 369 (*)	65	0,128	4	€ 495,00							
	SX <i>left</i>	115 370 (*)											
MODULO BASE ANGOLARE 2 FASCE LEGNO <i>angular base module with 2 wooden bands</i>   L.70,1 x p.70,1 x H.106,5	DX <i>right</i>	115 371 (*)	57	0,128	4	€ 435,00	(*)	PIANO	PANNELLO INTERNO	FASCE	top	internal panel	bands
	SX <i>left</i>	115 372 (*)					COMPLETARE SEMPRE CON COPPIA FASCE SUPERIORI IN VETRO ART.378 oppure POLICARBONATO CON LED ART.379 <i>to be always complete with set of 2 upper glass bands art.378 or polycarbonate with led art.379</i>						
MODULO BASE ANGOLARE 3 FASCE LEGNO <i>angular base module with 3 wooden bands</i>   L.185,1 x p.150,1 x H.106,5	DX <i>right</i>	115 421 (*)	157	0,372	6	€ 1.134,00	419	NOCE ITALIA	BIANCO BR. NOCE ITALIA	italy walnut	br. white	italy walnut	
	SX <i>left</i>	115 422 (*)					COMPLETARE SEMPRE CON COPPIA FASCE SUPERIORI IN VETRO ART.378 oppure POLICARBONATO CON LED ART.379 <i>to be always complete with set of 2 upper glass bands art.378 or polycarbonate with led art.379</i>						
MODULO BASE ANGOLARE 2 FASCE LEGNO <i>angular module with 2 wooden bands</i>   L.185,1 x p.150,1 x H.106,5	DX <i>right</i>	115 424 (*)	140	0,372	6	€ 996,00	519	NOCE ITALIA	NERO NOCE ITALIA	italy walnut	black	italy walnut	
	SX <i>left</i>	115 425 (*)					COMPLETARE SEMPRE CON COPPIA FASCE SUPERIORI IN VETRO ART.432 oppure POLICARBONATO CON LED ART.433 <i>to be always complete with set of 2 upper glass bands art.432 or polycarbonate with led art.433</i>						
							445	BIANCO NAT. MAT	BIANCO BR. NERO H.G.	natur mat white	br. white	h.g. black	
							448	BIANCO NAT. MAT	BIANCO BR. BIANCO H.G.	natur mat white	br. white	h.g. white	
							446	BIANCO BR.	BIANCO BR. NERO H.G.	br. white	br. white	h.g. black	
							447	BIANCO BR.	BIANCO BR. BIANCO H.G.	br. white	br. white	h.g. white	
							450	BIANCO BR.	BIANCO BR. ZEBRANO H.G.	br. white	br. white	h.g. zebra wood	
							470	BIANCO BR.	BIANCO BR. LARICE MOKA	br. white	br. white	moka larch	
							480	BIANCO BR.	BIANCO BR. LARICE SABBIA	br. white	br. white	sand larch	
							549	NERO NAT. MAT	NERO NERO H.G.	natur mat black	black	h.g. black	
							550	NERO NAT. MAT	NERO ZEBRANO H.G.	natur mat black	black	h.g. zebra wood	
							700	LARICE MOKA	NERO LARICE MOKA	moka larch	black	moka larch	
							740	LARICE MOKA	BIANCO BR. LARICE MOKA	moka larch	br. white	moka larch	
							800	LARICE SABBIA	BIANCO BR. LARICE SABBIA	sand larch	br. white	sand larch	

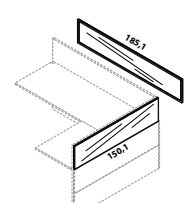
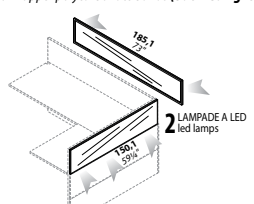

<b>FASCE SUPERIORI VETRO oppure POLICARBONATO CON LED</b> <i>upper glass bands or polycarbonate with led</i>										
DESCRIZIONE <i>description</i>	L <i>w</i>	CODICE <i>code</i>	KG	M <sup>3</sup>	COLLI 	PREZZO <i>price</i>	PREZZO <i>price</i>	(*) CODICE FINITURA <i>(*) finish code</i>		
FASCIA SUPERIORE IN VETRO <i>upper glass band</i>    L. x p.1,8 x H.35								<input checked="" type="radio"/> VETRO FLOAT TEMPERATO RETROLACCATO <i>tempered float glass rear-lacquered</i>		
								<input type="radio"/> FASCIA <i>band</i>		
								<input checked="" type="radio"/> 510 NERO <i>black</i>		
								<input type="radio"/> VETRO EXTRACHIARO TEMPERATO RETROLACCATO <i>tempered extraclear glass rear-lacquered</i>		
	L.80	115 <b>347</b> (*)	9	0,009	1	€ 121,00	€ 135,00	<input type="radio"/> FASCIA <i>band</i>		
	L.120	115 <b>348</b> (*)	11	0,016	1	€ 154,00	€ 174,00	<input checked="" type="radio"/> 478 BIANCO EXTRA <i>extra white</i>		
	L.180	115 <b>349</b> (*)	13	0,020	1	€ 198,00	€ 221,00			
FASCIA SUPERIORE IN POLICARBONATO <b>RETROILLUMINATO A LED</b> <i>upper polycarbonate band (back led lighting)</i>    L. x p.1,8 x H.35								<input checked="" type="radio"/> POLICARBONATO <i>polycarbonate</i>		
								<input type="radio"/> FASCIA <i>band</i>		
									<input checked="" type="radio"/> 499 BIANCO <i>white</i>	
									<input type="radio"/> VETRO EXTRACHIARO TEMPERATO RETROLACCATO <i>tempered extraclear glass rear-lacquered</i>	
		VERSIONE A LED <i>led version</i>								
	L.80	115 <b>351</b> (*)	3	0,009	1	€ 219,00				
	L.120	115 <b>352</b> (*)	5	0,016	1	€ 306,00				
	L.180	115 <b>353</b> (*)	9	0,020	1	€ 435,00				
 <b>COMPLETARE SEMPRE CON KIT ACCENSIONE CENTRALIZZATA</b> <i>to be always complete with power centralized kit</i>								<input checked="" type="radio"/> E		
COPPIA FASCE SUPERIORI IN VETRO <i>set of 2 upper glass bands</i>    L.70,1 x p.1,8 x H.35								<input checked="" type="radio"/> VETRO FLOAT TEMPERATO RETROLACCATO <i>tempered float glass rear-lacquered</i>		
								<input type="radio"/> FASCIA <i>band</i>		
									<input checked="" type="radio"/> 510 NERO <i>black</i>	
									<input type="radio"/> VETRO EXTRACHIARO TEMPERATO RETROLACCATO <i>tempered extraclear glass rear-lacquered</i>	
		115 <b>378</b> (*)	18	0,020	2	€ 224,00	€ 253,00	<input type="radio"/> FASCIA <i>band</i>		
								<input checked="" type="radio"/> 478 BIANCO EXTRA <i>extra white</i>		
COPPIA FASCE SUPERIORI IN POLICARBONATO <b>RETROILLUMINATO A LED</b> <i>set of 2 upper polycarbonate bands (back led lighting)</i>    L.70,1 x p.1,8 x H.35								<input checked="" type="radio"/> POLICARBONATO <i>polycarbonate</i>		
								<input type="radio"/> FASCIA <i>band</i>		
									<input checked="" type="radio"/> 499 BIANCO <i>white</i>	
									<input type="radio"/> VETRO EXTRACHIARO TEMPERATO RETROLACCATO <i>tempered extraclear glass rear-lacquered</i>	
		VERSIONE A LED <i>led version</i>								
		115 <b>379</b> (*)	21	0,030	2	€ 426,00				
 <b>COMPLETARE SEMPRE CON KIT ACCENSIONE CENTRALIZZATA</b> <i>to be always complete with power centralized kit</i>								<input checked="" type="radio"/> E		
COPPIA FASCE SUPERIORI IN VETRO <i>set of 2 upper glass bands</i>    L.185,1-150,1 x p.1,8 x H.35								<input checked="" type="radio"/> VETRO FLOAT TEMPERATO RETROLACCATO <i>tempered float glass rear-lacquered</i>		
								<input type="radio"/> FASCIA <i>band</i>		
									<input checked="" type="radio"/> 510 NERO <i>black</i>	
									<input type="radio"/> VETRO EXTRACHIARO TEMPERATO RETROLACCATO <i>tempered extraclear glass rear-lacquered</i>	
		115 <b>432</b> (*)	30	0,056	2	€ 366,00	€ 409,00	<input type="radio"/> FASCIA <i>band</i>		
								<input checked="" type="radio"/> 478 BIANCO EXTRA <i>extra white</i>		
COPPIA FASCE SUPERIORI IN POLICARBONATO <b>RETROILLUMINATO A LED</b> <i>set of 2 upper polycarbonate bands (back led lighting)</i>    L.185,1-150,1 x p.1,8 x H.35								<input checked="" type="radio"/> POLICARBONATO <i>polycarbonate</i>		
								<input type="radio"/> FASCIA <i>band</i>		
									<input checked="" type="radio"/> 499 BIANCO <i>white</i>	
									<input type="radio"/> VETRO EXTRACHIARO TEMPERATO RETROLACCATO <i>tempered extraclear glass rear-lacquered</i>	
		VERSIONE A LED <i>led version</i>								
		115 <b>433</b> (*)	33	0,056	2	€ 786,00				
 <b>COMPLETARE SEMPRE CON KIT ACCENSIONE CENTRALIZZATA</b> <i>to be always complete with power centralized kit</i>								<input checked="" type="radio"/> E		





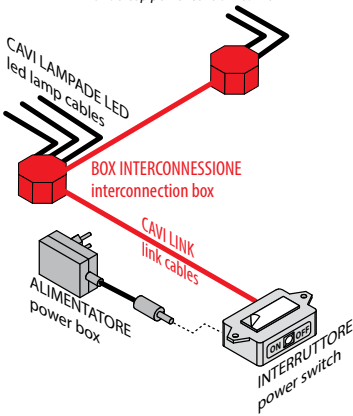

NICE  
reception

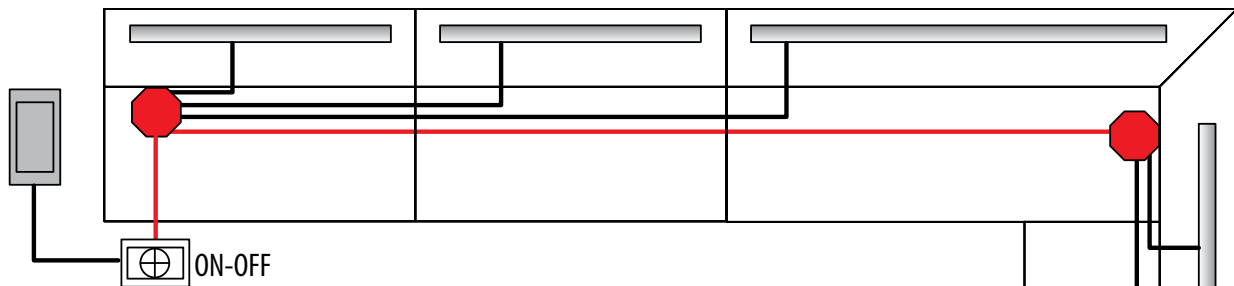

**KIT ACCENSIONE LED CENTRALIZZATA***power centralized kit*

DESCRIZIONE <i>description</i>	CODICE <i>code</i>	KG	M <sup>3</sup>	COLLI	PREZZO <i>price</i>	(*) CODICE FINITURA <i>(*) finish code</i>
ACCENSIONE CENTRALIZZATA SOTTOPIANO <i>undertop power centralized kit</i>  	X 1 LAMPADA LED <i>for 1 led lamp</i>	115 461 (*)	1	0,020	1	€ 85,00
	FINO A 5 LAMP. LED <i>until 5 led lamps</i>	115 462 (*)	2	0,030	1	€ 269,00
	FINO A 10 LAMP. LED <i>until 10 led lamps</i>	115 463 (*)	3	0,040	1	€ 425,00
						(*)
						000 NEUTRO <i>neuter</i>

**ESEMPI ACCENSIONE LED CENTRALIZZATA***examples of power centralized led lamps***ACCENSIONE CENTRALIZZATA SOTTOPIANO  
undertop power centralized kit****LEGENDA / key list**

-  = LAMPADA A LED / led lamps
-  = CAVI PER LAMPADA LED / cables for led lamps
-  = BOX INTERCONNESSIONE / interconnection box
-  = INTERRUTTORE / power switch
-  = ALIMENTATORE / power box
-  = CAVI LINK / link cables



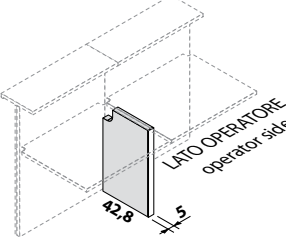
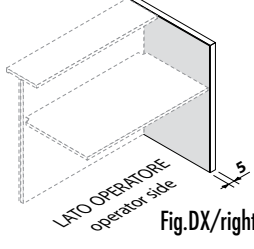

**ELEMENTI DI SUPPORTO**
*supporting elements*

DESCRIZIONE <i>description</i>	L w	CODICE <i>code</i>	KG 	M <sup>3</sup> 	COLLI 	PREZZO <i>price</i>	(*) CODICE FINITURA <i>(*) finish code</i>
FIANCO SOTTOPIANO CENTRALE <i>central undertop panel</i>    LATO OPERATORE <i>operator side</i>  L.5 x p.42,8 x H.71		115 435 (*)	12	0,025	1	€ 139,00	
FIANCONE TERMINALE DX O SX <i>right or left end panel</i>    LATO OPERATORE <i>operator side</i>  Fig.DX/right  L.5 x p.83,7 x H.110,3	DX <i>right</i>	115 437 (*)	32	0,075	1	€ 282,00	
	SX <i>left</i>	115 438 (*)					
							(*)
							190 NOCE ITALIA <i>italy walnut</i>
							415 BIANCO NATUR MAT <i>natur mat white</i>
							440 BIANCO BR. <i>br. white</i>
							516 NERO NATUR MAT <i>natur mat black</i>
							650 ZEBRANO HIGH GLOSS <i>high glass zebra wood</i>

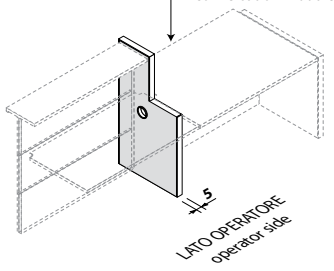
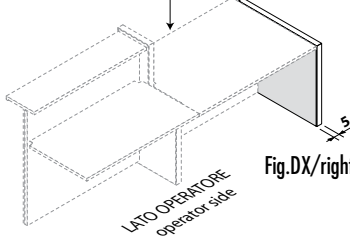
**ELEMENTI DI SUPPORTO PER MODULI CONVERSAZIONE**
*supporting elements for conversation modules*

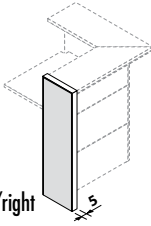
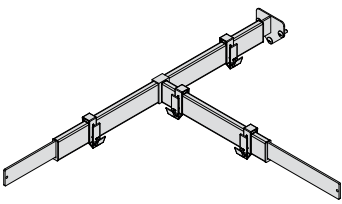

FIANCONE SAGOMATO CENTRALE PER MODULI CONVERSAZIONE <i>shaped central panel for conversation modules</i>  MODULO CONVERSAZIONE TERMINALE DX O SX <i>right or left terminal conversation modules</i>    LATO OPERATORE <i>operator side</i>  L.5 x p.59,8 x H.110,3		115 439 (*)	22	0,050	1	€ 273,00	
FIANCO DX O SX PER MODULI CONVERSAZIONE TERMINALI <i>right or left panel for terminal conversation modules</i>  MODULO CONVERSAZIONE TERMINALE DX O SX <i>right or left terminal conversation modules</i>    LATO OPERATORE <i>operator side</i>  Fig.DX/right  L.5 x p.83,7 x H.74,3	DX <i>right</i>	115 440 (*)	22	0,059	1	€ 231,00	
	SX <i>left</i>	115 441 (*)					
							(*)
							190 NOCE ITALIA <i>italy walnut</i>
							415 BIANCO NATUR MAT <i>natur mat white</i>
							440 BIANCO BR. <i>br. white</i>
							516 NERO NATUR MAT <i>natur mat black</i>
							650 ZEBRANO HIGH GLOSS <i>high glass zebra wood</i>

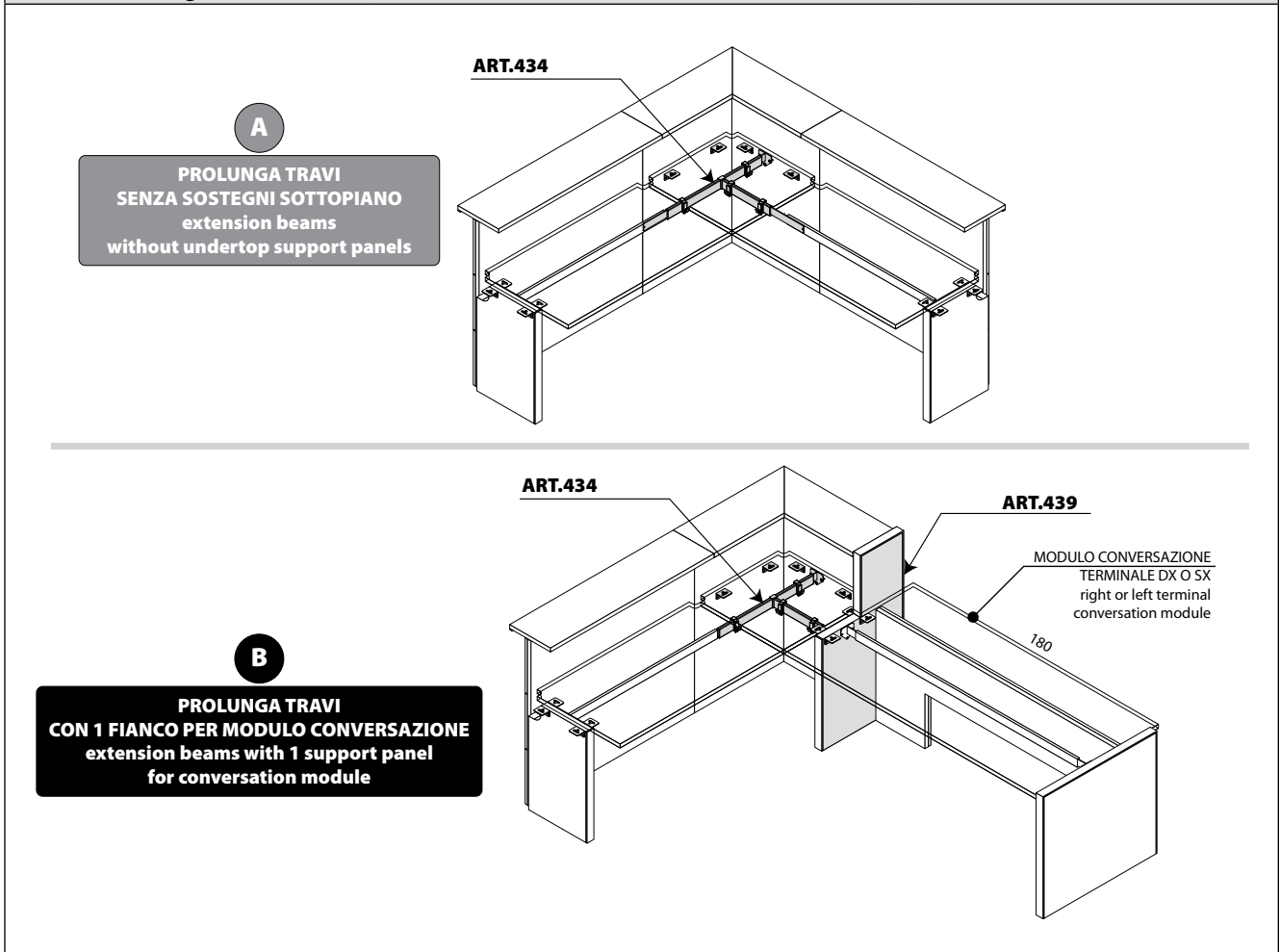

**ELEMENTI DI SUPPORTO**
*supporting elements*

DESCRIZIONE <i>description</i>	L <i>w</i>	CODICE <i>code</i>	KG 	M <sup>3</sup> 	COLLI 	PREZZO <i>price</i>	(*) CODICE FINITURA <i>(*) finish code</i>
FIANCO TERMINALE DX O SX PER MODULO ANGOLARE L.70,1x70,1 <i>right or left end panel for angular module w 70,1x70,1 cms</i>    Fig.DX/right  L.5 x p.31,6 x H.110,3							
	DX <i>right</i> SX <i>left</i>	115 <b>443</b> (*) 115 <b>444</b> (*)	12	0,029	1	<b>€ 148,00</b>	(*) <b>190</b> NOCE ITALIA <i>italy walnut</i> <b>415</b> BIANCO NATUR MAT <i>natur mat white</i> <b>440</b> BIANCO BR. <i>br. white</i> <b>516</b> NERO NATUR MAT <i>natur mat black</i> <b>650</b> ZEBRANO HIGH GLOSS <i>high gloss zebrawood</i>
KIT PROLUNGA TRAVI PER MODULO ANGOLARE L.70,1x70,1 <i>beams extension kit for angular module w 70,1x70,1 cms</i>  							
		115 <b>434</b> (*)	4	0,010	1	<b>€ 105,00</b>	(*) <b>000</b> ARGENTO METALLIZZATO <i>metallic silver</i>

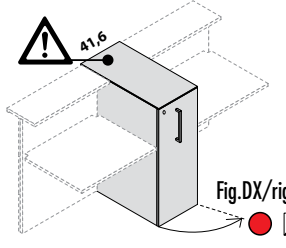
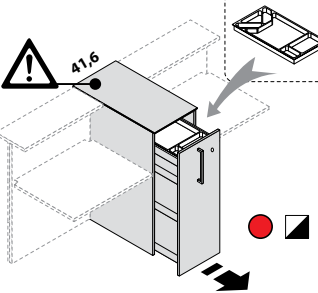
**SCHEMA DI UTILIZZO PROLUNGA TRAVI**
*scheme of using extension beams*

**B** **C**

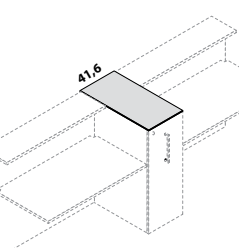
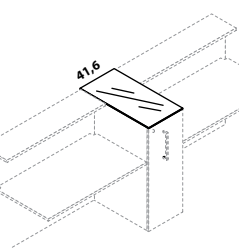
ELEMENTI DI SUPPORTO supporting elements																									
DESCRIZIONE description	L w	CODICE code	KG	M <sup>3</sup>	COLLI	PREZZO price	(*) CODICE FINITURA (* finish code)																		
STORAGE CON 1 ANTA LEGNO CON SERRATURA storage with 1 wooden door with lock   Fig.DX/right																									
	DX right	115 471 (*)	61	0,171	4	€ 449,00																			
	SX left	115 472 (*)																							
▲ COMPLETARE SEMPRE CON TOP ART.487-488 to be always complete with top ART.487-488																									
<table border="1"> <thead> <tr> <th>(*)</th> <th>TOP</th> <th>top</th> </tr> </thead> <tbody> <tr> <td>190</td> <td>NOCE ITALIA</td> <td>italy walnut</td> </tr> <tr> <td>415</td> <td>BIANCO NATUR. MAT</td> <td>natur mat white</td> </tr> <tr> <td>440</td> <td>BIANCO BR.</td> <td>br. white</td> </tr> <tr> <td>516</td> <td>NERO NATUR. MAT</td> <td>natur mat black</td> </tr> <tr> <td>650</td> <td>ZEBRANO HIGH GLOSS</td> <td>high gloss zebra wood</td> </tr> </tbody> </table>								(*)	TOP	top	190	NOCE ITALIA	italy walnut	415	BIANCO NATUR. MAT	natur mat white	440	BIANCO BR.	br. white	516	NERO NATUR. MAT	natur mat black	650	ZEBRANO HIGH GLOSS	high gloss zebra wood
(*)	TOP	top																							
190	NOCE ITALIA	italy walnut																							
415	BIANCO NATUR. MAT	natur mat white																							
440	BIANCO BR.	br. white																							
516	NERO NATUR. MAT	natur mat black																							
650	ZEBRANO HIGH GLOSS	high gloss zebra wood																							
L.41,6 x p.83,7 x H.110,3																									
STORAGE STANDARD CON SERRATURA (DOTATO DI VASCHETTA PORTA-CANCELLERIA) standard storage with lock (with stationary tray)  																									
		115 474 (*)	83	0,233	5	€ 719,00																			
	▲ COMPLETARE SEMPRE CON TOP ART.487-488 to be always complete with top ART.487-488																								
L.41,6 x p.83,7 x H.110,3																									

TOP PER STORAGE top for storage																															
DESCRIZIONE description	L w	CODICE code	KG	M <sup>3</sup>	COLLI	PREZZO price	PREZZO price	(*) CODICE FINITURA (* finish code)																							
TOP IN LEGNO PER STORAGE wooden top for storage  																															
		115 487 (*)	7	0,016	1	€ 38,00																									
	<table border="1"> <thead> <tr> <th>(*)</th> <th>TOP</th> <th>top</th> </tr> </thead> <tbody> <tr> <td>190</td> <td>NOCE ITALIA</td> <td>italy walnut</td> </tr> <tr> <td>415</td> <td>BIANCO NATUR. MAT</td> <td>natur mat white</td> </tr> <tr> <td>440</td> <td>BIANCO BR.</td> <td>br. white</td> </tr> <tr> <td>516</td> <td>NERO NATUR. MAT</td> <td>natur mat black</td> </tr> <tr> <td>650</td> <td>ZEBRANO HIGH GLOSS</td> <td>high gloss zebra wood</td> </tr> <tr> <td>700</td> <td>LARICE MOKA</td> <td>moka larch</td> </tr> <tr> <td>800</td> <td>LARICE SABBIA</td> <td>sand larch</td> </tr> </tbody> </table>								(*)	TOP	top	190	NOCE ITALIA	italy walnut	415	BIANCO NATUR. MAT	natur mat white	440	BIANCO BR.	br. white	516	NERO NATUR. MAT	natur mat black	650	ZEBRANO HIGH GLOSS	high gloss zebra wood	700	LARICE MOKA	moka larch	800	LARICE SABBIA
(*)	TOP	top																													
190	NOCE ITALIA	italy walnut																													
415	BIANCO NATUR. MAT	natur mat white																													
440	BIANCO BR.	br. white																													
516	NERO NATUR. MAT	natur mat black																													
650	ZEBRANO HIGH GLOSS	high gloss zebra wood																													
700	LARICE MOKA	moka larch																													
800	LARICE SABBIA	sand larch																													
L.41,6 x p.83,7 x H.1,8																															
TOP IN VETRO PER STORAGE glass top for storage  																															
		115 488 (*)	8	0,020	1	€ 137,00	€ 173,00																								
	<table border="1"> <thead> <tr> <th>(*)</th> <th>TOP VETRO</th> <th>glass top</th> </tr> </thead> <tbody> <tr> <td>510</td> <td>NERO</td> <td>black</td> </tr> </tbody> </table> <table border="1"> <thead> <tr> <th>(*)</th> <th>TOP VETRO</th> <th>glass top</th> </tr> </thead> <tbody> <tr> <td>478</td> <td>BIANCO EXTRA</td> <td>extra white</td> </tr> </tbody> </table>								(*)	TOP VETRO	glass top	510	NERO	black	(*)	TOP VETRO	glass top	478	BIANCO EXTRA	extra white											
(*)	TOP VETRO	glass top																													
510	NERO	black																													
(*)	TOP VETRO	glass top																													
478	BIANCO EXTRA	extra white																													
L.41,6 x p.83,7 x H.0,6																															

NICE  
reception

**MENSOLE**  
*shelves*

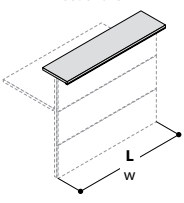
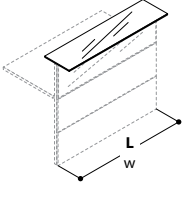
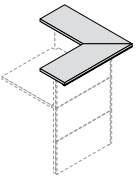
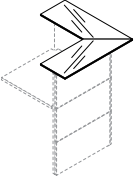
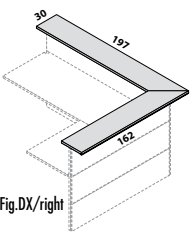
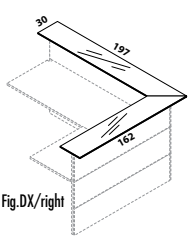
DESCRIZIONE <i>description</i>	L <i>w</i>	CODICE <i>code</i>	KG	M <sup>3</sup>	COLLI	PREZZO <i>price</i>	PREZZO <i>price</i>	(*) CODICE FINITURA <i>(*) finish code</i>
MENSOLA LEGNO <i>wooden shelf</i>  L x p.30 x H.2,5+0,5	L.80 w 31½"	115 <b>339</b> (*)	8	0,017	2	€ 93,00		(*) MENSOLE shelves
	L.120 w 47¼"	115 <b>340</b> (*)	11	0,025	2	€ 137,00		190 NOCE ITALIA <i>italy walnut</i>
	L.180 w 71"	115 <b>341</b> (*)	14	0,037	2	€ 174,00		415 BIANCO NATUR. MAT <i>natur mat white</i>
								440 BIANCO BR. <i>br. white</i>
								516 NERO NATUR. MAT <i>natur mat black</i>
								700 LARICE MOKA <i>moka larch</i>
								800 LARICE SABBIA <i>sand larch</i>
MENSOLA IN VETRO <i>glass shelf</i>  L x p.30 x H.1,2+1,8	L.80 w 31½"	115 <b>343</b> (*)	8,1	0,016	2	€ 215,00	€ 241,00	(*) MENSOLE shelves
	L.120 w 47¼"	115 <b>344</b> (*)	11,7	0,022	2	€ 278,00	€ 315,00	499 BIANCO SATINATO <i>satinated white</i>
	L.180 w 71"	115 <b>345</b> (*)	17,1	0,032	2	€ 381,00	€ 439,00	510 NERO <i>black</i>
								(*) MENSOLE shelves
								478 BIANCO EXTRA <i>extra white</i>
COPPIA MENSOLE ANGOLARI IN LEGNO <i>set of 2 angular wooden shelves</i>  L.82 x p.82 x H.2,5+0,5		115 <b>375</b> (*)	13	0,025	2	€ 194,00		(*) MENSOLE shelves
								190 NOCE ITALIA <i>italy walnut</i>
								415 BIANCO NATUR. MAT <i>natur mat white</i>
								440 BIANCO BR. <i>br. white</i>
								516 NERO NATUR. MAT <i>natur mat black</i>
								700 LARICE MOKA <i>moka larch</i>
								800 LARICE SABBIA <i>sand larch</i>
COPPIA MENSOLE ANGOLARI IN VETRO <i>set of 2 angular glass shelves</i>  L.82 x p.82 x H.1,2+1,8		115 <b>376</b> (*)	15,6	0,022	3	€ 562,00	€ 606,00	(*) MENSOLE shelves
								499 BIANCO SATINATO <i>satinated white</i>
								510 NERO <i>black</i>
								(*) MENSOLE shelves
								478 BIANCO EXTRA <i>extra white</i>
COPPIA MENSOLE ANGOLARI IN LEGNO <i>set of 2 angular wooden shelves</i>  Fig.DX/right L.197 x p.162 x H.2,5+0,5	DX right	115 <b>427</b> (*)	25	0,057	2	€ 340,00		(*) MENSOLE shelves
	SX left	115 <b>428</b> (*)						
								415 BIANCO NATUR. MAT <i>natur mat white</i>
								440 BIANCO BR. <i>br. white</i>
								516 NERO NATUR. MAT <i>natur mat black</i>
								700 LARICE MOKA <i>moka larch</i>
								800 LARICE SABBIA <i>sand larch</i>
COPPIA MENSOLE ANGOLARI IN VETRO <i>set of 2 angular glass shelves</i>  Fig.DX/right L.197 x p.162 x H.1,2+1,8	DX right	115 <b>429</b> (*)	33,2	0,058	3	€ 930,00	€ 1.018,00	(*) MENSOLE shelves
	SX left	115 <b>430</b> (*)						
								510 NERO <i>black</i>
								(*) MENSOLE shelves
								478 BIANCO EXTRA <i>extra white</i>



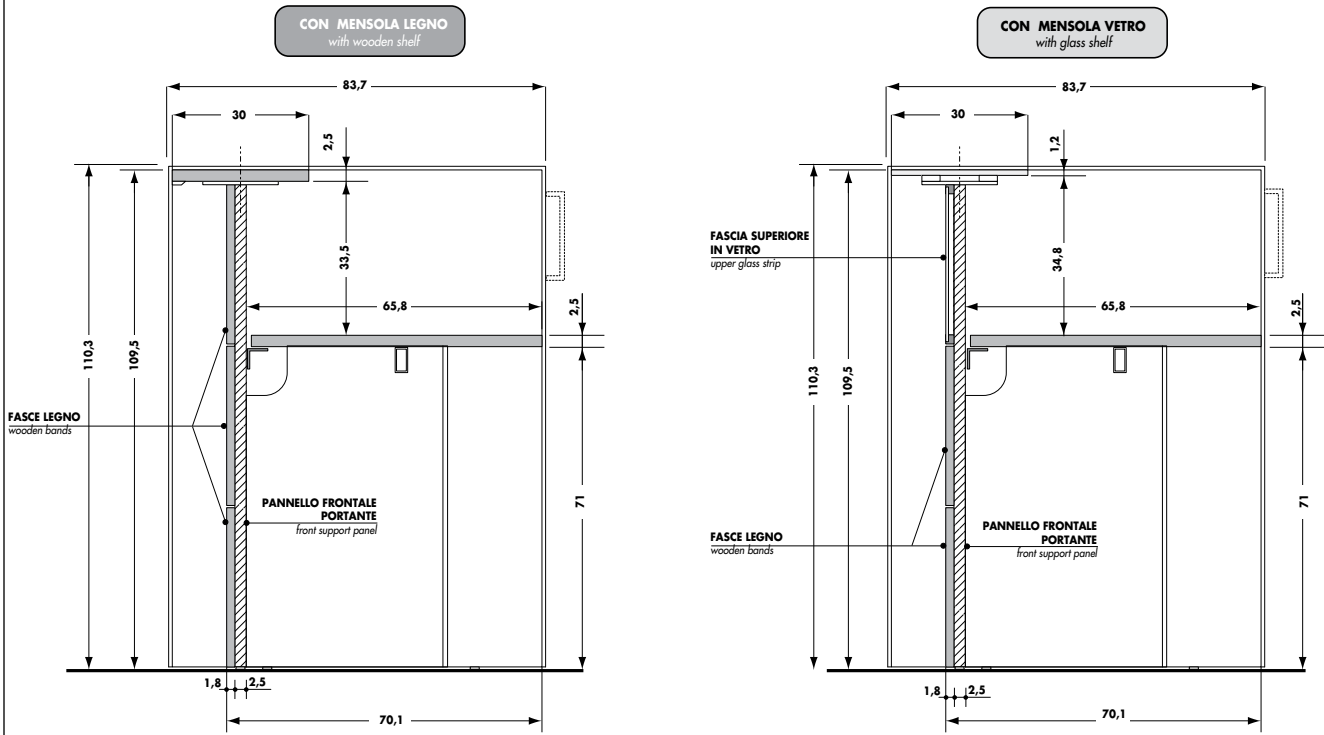

**DIMENSIONI**  
dimensions

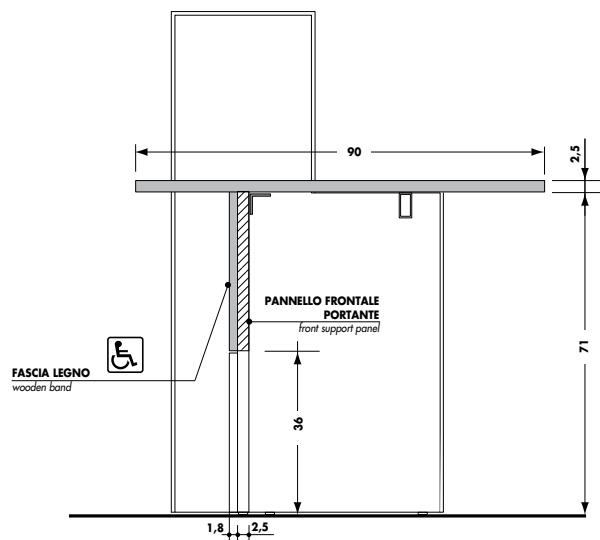

**MODULI CONVERSAZIONE**  
conversation modules

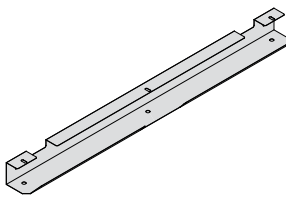
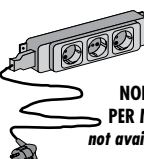
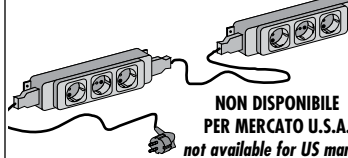

NICE  
reception

CANALI PORTA-CAVI E KIT PER ELETTRIFICAZIONE cable channels and electrification kit							
DESCRIZIONE description	L w	CODICE code	KG	M <sup>3</sup>	COLLI	PREZZO price	(*) CODICE FINITURA (*) finish code
CANALI PORTA-CAVI IN LAMIERA plate cable channels  							(*)
							000 ARGENTO silver
							450 BIANCO white
							551 ANTRACITE anthracite
							844 STONE GREY stone grey
							PROSPETTO INFORMATIVO information sheet
						CANALE PORTA-CAVI cable channel	UTILIZZABILE SU MODULI BASE usable on base modules
						2 pz. ART.451	ANGOLO L.70,1 x p.70,1 corner w 70,1 x d 70,1 cms
						ART.453	L.80
						ART.456	L.120
						ART.459	L.180
						ART.459+ ART.457	ANGOLO L.185,1 x p.150,1 corner w 185,1 x d 150,1 cms
KIT ELETTTRIF. SINGOLO CON PRESE SCHUKO E CAVO DI ALIMENTAZIONE DI MT. 2,00 single electrif. kit with <b>SCHUKO</b> sockets and power cable w 2 lmt.   <b>NON DISPONIBILE PER MERCATO U.S.A. not available for US market</b>		175 899 (*)	1	0,006	1	€ 86,00	
KIT ELETTTRIF. DOPPIO CON PRESE SCHUKO E CAVO DI ALIMENTAZIONE DI MT. 2,00 double electrif. kit with <b>SCHUKO</b> sockets and power cable w 2 lmt.   <b>NON DISPONIBILE PER MERCATO U.S.A. not available for US market</b>		175 900 (*)	1	0,006	1	€ 160,00	(*)
							500 NERO black
KIT PROLUNGA DI MT. 2,00 CON PRESA ENTRATA/1 USCITA extension kit of w 2 lmt. with an input-and-out-put-plug   <b>NON DISPONIBILE PER MERCATO U.S.A. not available for US market</b>		175 901 (*)	0,5	0,002	1	€ 30,00	

**ESEMPIO DI UTILIZZO CANALI PORTA CAVI**  
Examples for using cable channels

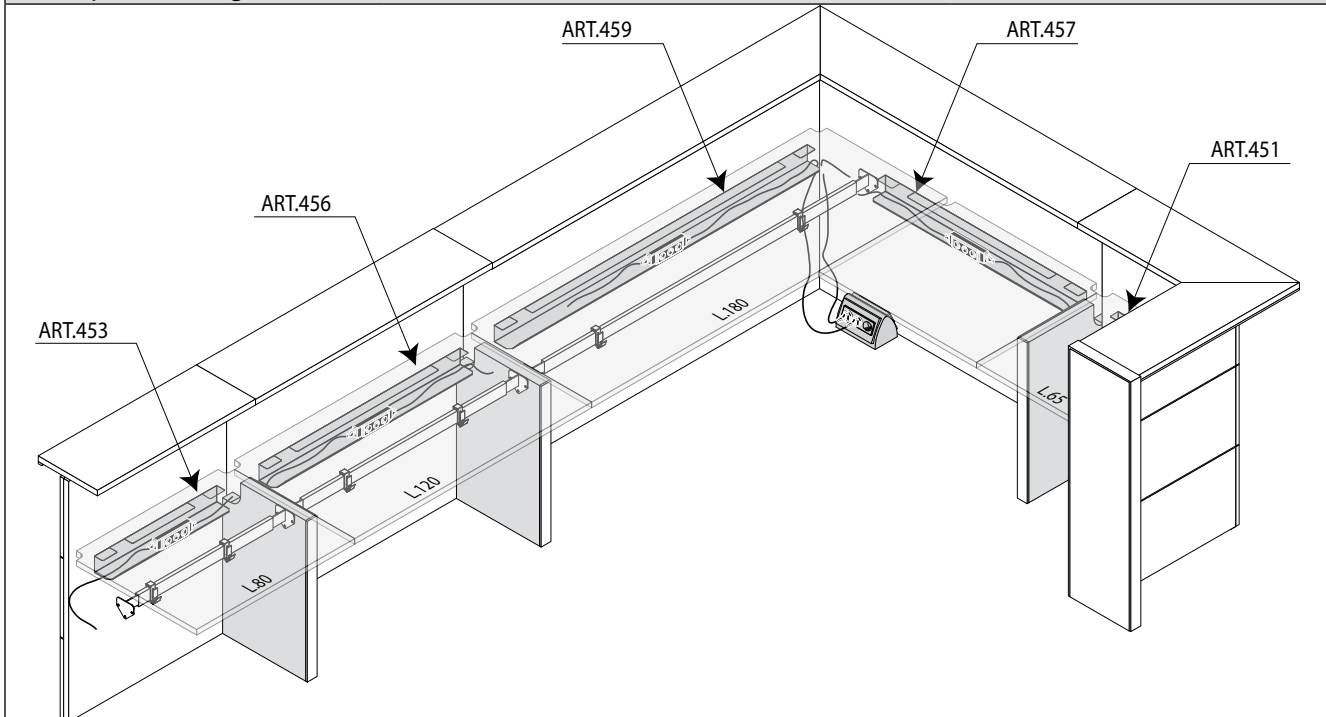

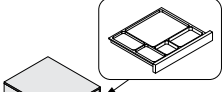
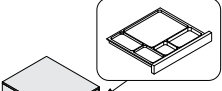
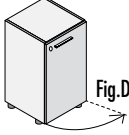
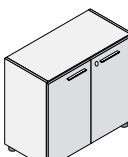
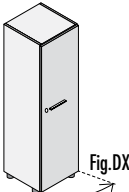
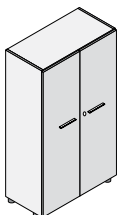
CASSETTIERE SU RUOTE pedestals on wheels							
DESCRIZIONE description	L w	CODICE code	KG	M <sup>3</sup>	COLLI	PREZZO price	(*) CODICE FINITURA (* finish code)
CASSETTIERA SU RUOTE 2 CASSETTI (CON 1 PORTA-CANCELLERIA INTERNO) pedestal on wheels with 2 drawers (with 1 internal stationery-tray)	L44,2	115 792 (*)	24	0,140	1	€ 448,00	
	 <p>APERTURA "PREMI-APRI" opening with "push-open" system</p> <p>L.44,2 x p.53,1 x H.59,7</p>						(*) 190 NOCE ITALIA italy walnut 415 BIANCO NATUR MAT natur mat white 440 BIANCO BR. br. white 516 NERO NATUR MAT natur mat black
CASSETTIERA-CLASSIFICATORE SU RUOTE (CON 1 PORTA-CANCELLERIA INTERNO) pedestal on wheels with 1 file-drawer (with 1 internal stationery-tray)	L44,2	115 793 (*)	22	0,140	1	€ 470,00	
	 <p>APERTURA "PREMI-APRI" opening with "push-open" system</p> <p>L.44,2 x p.53,1 x H.59,7</p>						650 ZEBRANO HIGH GLOSS high gloss zebra wood 700 LARICE MOKA moka larch 800 LARICE SABBIA sand larch  STRUTTURA INTERNA: BIANCO BR. internal structure: br. white
<b>MOBILI BASSI</b> low cabinets							
TUTTE LE COMPOSIZIONI CON I MOBILI CONTENITORI DEVONO ESSERE COMPLETATE CON TOP + 2 FIANCHI FINALI (VEDI PAG. 18) always complete the compositions with top + 2 final side panels (please see page 18)							
MOBILE BASSO L.45 CON 1 ANTA LEGNO CON CHIUSURA AMMORTIZZATA E SERRATURA low cabinet w 17 1/2" with 1 soft-close wooden door and lock	DX right L.45	115 952 (*)	27	0,071	4	€ 166,00	
	SX left L.45	115 953 (*)					(*) ANTE STRUTTURA doors structure 415 BIANCO NATUR MAT BIANCO BR. natur mat white br. white 416 NERO NATUR MAT BIANCO BR. natur mat black br. white 419 NOCE ITALIA BIANCO BR. italy walnut br. white 440 BIANCO BR. BIANCO BR. br. white br. white 450 ZEBRANO HIGH GLOSS BIANCO BR. high gloss zebra wood br. white 470 LARICE MOKA BIANCO BR. moka larch br. white 480 LARICE SABBIA BIANCO BR. sand larch br. white
 <p>Fig.DX/right</p> <p>L.45 x p.46,3 x H.81,5</p>							
MOBILE BASSO L.90 CON 2 ANTE LEGNO CON CHIUSURA AMMORTIZZATA E SERRATURA low cabinet w 35 1/2" with 2 soft-close wooden doors and lock	L.90	115 954 (*)	43	0,107	4	€ 277,00	
	 <p>L.90 x p.46,3 x H.81,5</p>						
<b>MOBILI MEDI</b> medium cabinets							
TUTTE LE COMPOSIZIONI CON I MOBILI CONTENITORI DEVONO ESSERE COMPLETATE CON TOP + 2 FIANCHI FINALI (VEDI PAG. 18) always complete the compositions with top + 2 final side panels (please see page 18)							
MOBILE MEDIO L.45 CON 1 ANTA LEGNO CON CHIUSURA AMMORTIZZATA E SERRATURA medium cabinet w 17 1/2" with 1 soft-close wooden door and lock	DX right L.45	115 955 (*)	47	0,134	5	€ 286,00	
	SX left L.45	115 956 (*)					(*) ANTE STRUTTURA doors structure 415 BIANCO NATUR MAT BIANCO BR. natur mat white br. white 416 NERO NATUR MAT BIANCO BR. natur mat black br. white 419 NOCE ITALIA BIANCO BR. italy walnut br. white 440 BIANCO BR. BIANCO BR. br. white br. white 450 ZEBRANO HIGH GLOSS BIANCO BR. high gloss zebra wood br. white 470 LARICE MOKA BIANCO BR. moka larch br. white 480 LARICE SABBIA BIANCO BR. sand larch br. white
 <p>Fig.DX/right</p> <p>L.45 x p.46,3 x H.158,3</p>							
MOBILE MEDIO L.90 CON 2 ANTE LEGNO CON CHIUSURA AMMORTIZZATA E SERRATURA medium cabinet w 35 1/2" with 2 soft-close wooden doors and lock	L.90	115 957 (*)	78	0,202	5	€ 476,00	
	 <p>L.90 x p.46,3 x H.158,3</p>						

NICE reception

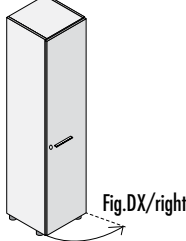
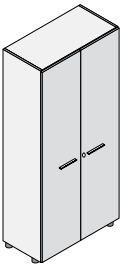
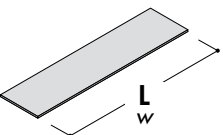
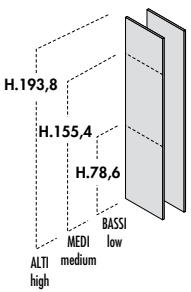

<b>MOBILI ALTI</b> <i>high cabinets</i>		<b>TUTTE LE COMPOSIZIONI CON I MOBILI CONTENITORI DEVONO ESSERE COMPLETATE CON TOP + 2 FIANCHI FINALI (VEDI SOTTO)</b> always complete the compositions with <b>top + 2 final side panels</b> (please see below page)																																													
DESCRIZIONE <i>description</i>	L <i>w</i>	CODICE <i>code</i>	KG	M <sup>3</sup>	COLLI	PREZZO <i>price</i>	(*) CODICE FINITURA <i>(*) finish code</i>																																								
MOBILE ALTO L.45 CON 1 ANTA LEGNO CON CHIUSURA AMMORTIZZATA E SERRATURA <i>high cabinet w 17¼" with 1 soft-close wooden door and lock</i>  Fig.DX/right L.45 x p.46,3 x H.196,7	<table border="1"> <tr> <td>DX <i>right</i></td> <td>L.45</td> <td>115 958 (*)</td> <td rowspan="2">59</td> <td rowspan="2">0,149</td> <td rowspan="2">5</td> <td rowspan="2">€ 366,00</td> </tr> <tr> <td>SX <i>left</i></td> <td>L.45</td> <td>115 959 (*)</td> </tr> </table>	DX <i>right</i>	L.45	115 958 (*)	59	0,149	5	€ 366,00	SX <i>left</i>	L.45	115 959 (*)																																				
DX <i>right</i>	L.45	115 958 (*)	59	0,149					5	€ 366,00																																					
SX <i>left</i>	L.45	115 959 (*)																																													
MOBILE ALTO L.90 CON 2 ANTE LEGNO CON CHIUSURA AMMORTIZZATA E SERRATURA <i>high cabinet w 35½" with 2 soft-close wooden doors and lock</i>  L.90 x p.46,3 x H.196,7	<table border="1"> <tr> <td>L.90</td> <td>115 960 (*)</td> <td>98</td> <td>0,249</td> <td>5</td> <td>€ 594,00</td> </tr> </table>	L.90	115 960 (*)	98	0,249	5	€ 594,00																																								
L.90	115 960 (*)	98	0,249	5	€ 594,00																																										
<table border="1"> <thead> <tr> <th>(*)</th> <th>ANTE</th> <th>STRUTTURA</th> <th>doors</th> <th>structure</th> </tr> </thead> <tbody> <tr> <td>415</td> <td>BIANCO NATUR MAT</td> <td>BIANCO BR.</td> <td>natur mat white</td> <td>br. white</td> </tr> <tr> <td>416</td> <td>NERO NATUR MAT</td> <td>BIANCO BR.</td> <td>natur mat black</td> <td>br. white</td> </tr> <tr> <td>419</td> <td>NOCE ITALIA</td> <td>BIANCO BR.</td> <td>italy walnut</td> <td>br. white</td> </tr> <tr> <td>440</td> <td>BIANCO BR.</td> <td>BIANCO BR.</td> <td>br. white</td> <td>br. white</td> </tr> <tr> <td>450</td> <td>ZEBRANO HIGH GLOSS</td> <td>BIANCO BR.</td> <td>high gloss zebrawood</td> <td>br. white</td> </tr> <tr> <td>470</td> <td>LARICE MOKA</td> <td>BIANCO BR.</td> <td>moka larch</td> <td>br. white</td> </tr> <tr> <td>480</td> <td>LARICE SABBIA</td> <td>BIANCO BR.</td> <td>sand larch</td> <td>br. white</td> </tr> </tbody> </table>								(*)	ANTE	STRUTTURA	doors	structure	415	BIANCO NATUR MAT	BIANCO BR.	natur mat white	br. white	416	NERO NATUR MAT	BIANCO BR.	natur mat black	br. white	419	NOCE ITALIA	BIANCO BR.	italy walnut	br. white	440	BIANCO BR.	BIANCO BR.	br. white	br. white	450	ZEBRANO HIGH GLOSS	BIANCO BR.	high gloss zebrawood	br. white	470	LARICE MOKA	BIANCO BR.	moka larch	br. white	480	LARICE SABBIA	BIANCO BR.	sand larch	br. white
(*)	ANTE	STRUTTURA	doors	structure																																											
415	BIANCO NATUR MAT	BIANCO BR.	natur mat white	br. white																																											
416	NERO NATUR MAT	BIANCO BR.	natur mat black	br. white																																											
419	NOCE ITALIA	BIANCO BR.	italy walnut	br. white																																											
440	BIANCO BR.	BIANCO BR.	br. white	br. white																																											
450	ZEBRANO HIGH GLOSS	BIANCO BR.	high gloss zebrawood	br. white																																											
470	LARICE MOKA	BIANCO BR.	moka larch	br. white																																											
480	LARICE SABBIA	BIANCO BR.	sand larch	br. white																																											
<b>TOPS + COPPIA DI FIANCHI FINALI</b> <i>tops + set of 2 final side panels</i>																																															
TOPS PER MOBILI <i>tops for cabinets</i>  L. x p.46,6 x H.1,8	<table border="1"> <tr> <td>L.93,8</td> <td>115 963 (*)</td> <td>8</td> <td>0,023</td> <td>1</td> <td>€ 80,00</td> </tr> <tr> <td>L.138,8</td> <td>115 964 (*)</td> <td>11</td> <td>0,032</td> <td>1</td> <td>€ 114,00</td> </tr> <tr> <td>L.183,8</td> <td>115 965 (*)</td> <td>14</td> <td>0,041</td> <td>1</td> <td>€ 144,00</td> </tr> <tr> <td>L.228,8</td> <td>115 966 (*)</td> <td>17</td> <td>0,046</td> <td>1</td> <td>€ 181,00</td> </tr> <tr> <td>L.273,8</td> <td>115 967 (*)</td> <td>19</td> <td>0,060</td> <td>1</td> <td>€ 218,00</td> </tr> </table>	L.93,8	115 963 (*)	8	0,023	1	€ 80,00	L.138,8	115 964 (*)	11	0,032	1	€ 114,00	L.183,8	115 965 (*)	14	0,041	1	€ 144,00	L.228,8	115 966 (*)	17	0,046	1	€ 181,00	L.273,8	115 967 (*)	19	0,060	1	€ 218,00																
L.93,8	115 963 (*)	8	0,023	1	€ 80,00																																										
L.138,8	115 964 (*)	11	0,032	1	€ 114,00																																										
L.183,8	115 965 (*)	14	0,041	1	€ 144,00																																										
L.228,8	115 966 (*)	17	0,046	1	€ 181,00																																										
L.273,8	115 967 (*)	19	0,060	1	€ 218,00																																										
<b>COMPLETARE SEMPRE CON FIANCHI FINALI</b> <i>always complete with final side panels</i> <b>ART.968-969-970</b>																																															
COPPIA FIANCHI FINALI PER MOBILI BASSI, MEDI E ALTI <i>set of 2 final side panels for low, medium and high cabinets</i>  H.193,8 H.155,4 H.78,6 ALTI medium high MEDI low BASSI sp.1,8 x p.46,6 x H.	<table border="1"> <tr> <td>H.78,6</td> <td>115 968 (*)</td> <td>16</td> <td>0,027</td> <td>1</td> <td>€ 137,00</td> </tr> <tr> <td>H.155,4</td> <td>115 969 (*)</td> <td>19</td> <td>0,051</td> <td>1</td> <td>€ 206,00</td> </tr> <tr> <td>H.193,8</td> <td>115 970 (*)</td> <td>23</td> <td>0,068</td> <td>1</td> <td>€ 319,00</td> </tr> </table>	H.78,6	115 968 (*)	16	0,027	1	€ 137,00	H.155,4	115 969 (*)	19	0,051	1	€ 206,00	H.193,8	115 970 (*)	23	0,068	1	€ 319,00																												
H.78,6	115 968 (*)	16	0,027	1	€ 137,00																																										
H.155,4	115 969 (*)	19	0,051	1	€ 206,00																																										
H.193,8	115 970 (*)	23	0,068	1	€ 319,00																																										
<b>COMPLETARE SEMPRE CON TOP</b> <i>always complete with top</i> <b>ART. 963-964-965-966-967</b>																																															
<table border="1"> <thead> <tr> <th>(*)</th> <th></th> <th></th> </tr> </thead> <tbody> <tr> <td>190</td> <td>NOCE ITALIA</td> <td>italy walnut</td> </tr> <tr> <td>415</td> <td>BIANCO NATUR MAT</td> <td>natur mat white</td> </tr> <tr> <td>440</td> <td>BIANCO BR.</td> <td>br. white</td> </tr> <tr> <td>516</td> <td>NERO NATUR MAT</td> <td>natur mat black</td> </tr> <tr> <td>650</td> <td>ZEBRANO HIGH GLOSS</td> <td>high gloss zebrawood</td> </tr> <tr> <td>700</td> <td>LARICE MOKA</td> <td>moka larch</td> </tr> <tr> <td>800</td> <td>LARICE SABBIA</td> <td>sand larch</td> </tr> </tbody> </table>								(*)			190	NOCE ITALIA	italy walnut	415	BIANCO NATUR MAT	natur mat white	440	BIANCO BR.	br. white	516	NERO NATUR MAT	natur mat black	650	ZEBRANO HIGH GLOSS	high gloss zebrawood	700	LARICE MOKA	moka larch	800	LARICE SABBIA	sand larch																
(*)																																															
190	NOCE ITALIA	italy walnut																																													
415	BIANCO NATUR MAT	natur mat white																																													
440	BIANCO BR.	br. white																																													
516	NERO NATUR MAT	natur mat black																																													
650	ZEBRANO HIGH GLOSS	high gloss zebrawood																																													
700	LARICE MOKA	moka larch																																													
800	LARICE SABBIA	sand larch																																													



# ESEMPI COMPOSIZIONI

examples compositions

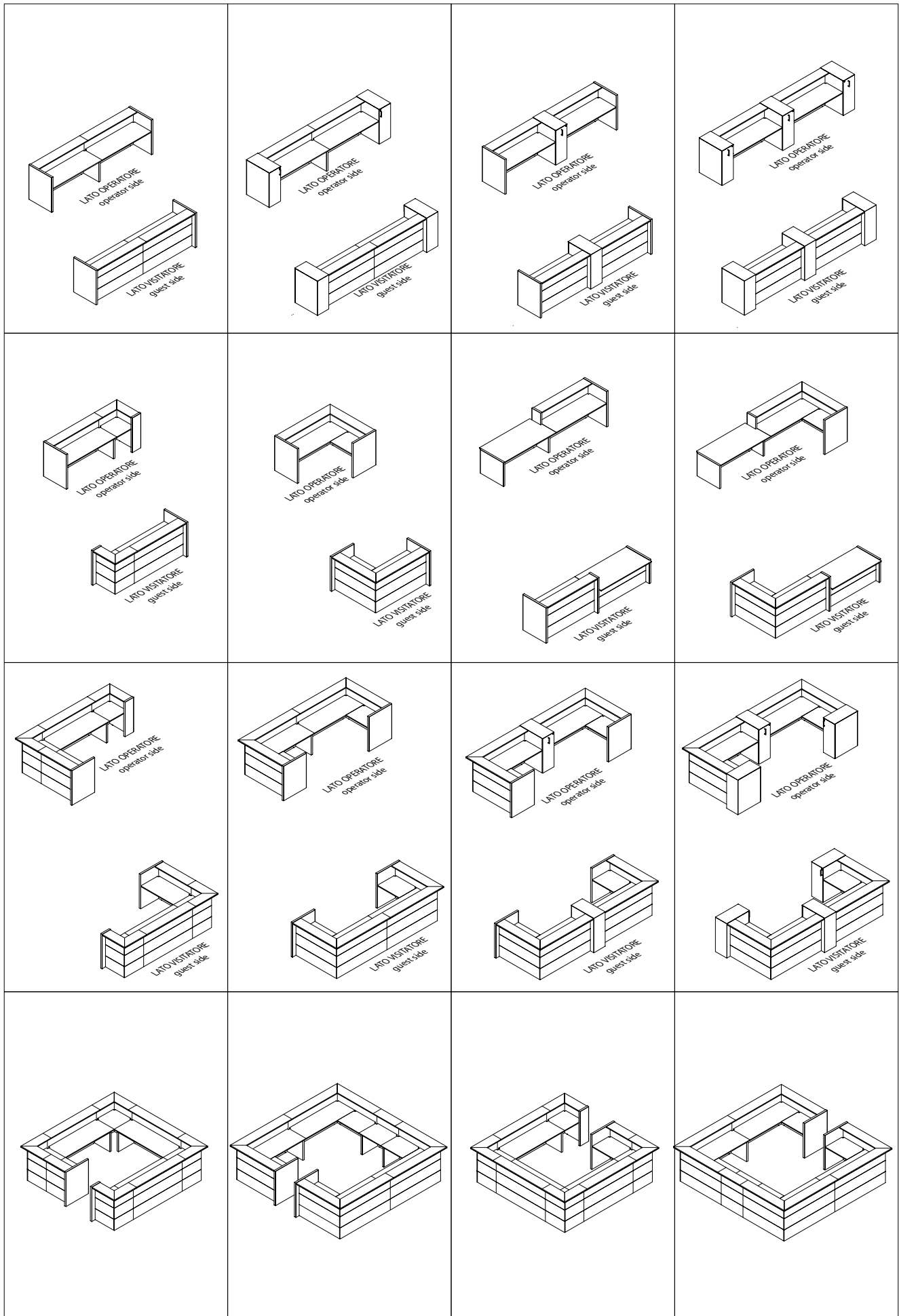

NICE  
reception

# NICE

## DESCRIZIONE TECNICA

### PIANI DI LAVORO:

Realizzati con pannelli in MDF spessore mm 25, rivestiti con 3d-foil. Sono disponibili nei colori: NOCE ITALIA 29, BIANCO BR. 69, BIANCO NATUR MAT 15, NERO NATUR MAT 16, LARICE MOKA 86, LARICE SABBIA 85. Gli angoli adiacenti al pannello verticale, presentano delle forature per il passaggio dei cablaggi. I piani di lavoro sono forniti con trave orizzontale di sostegno realizzata in tubolare metallico a sezione rettangolare 50 x 15x sp. 1,5 verniciata a polveri epossidiche ARGENTO METALLIZZATO.

### MENSOLE:

Sono disponibili in due tipologie:

A) --Finitura Legno : realizzati con pannelli in MDF spessore mm 25, rivestiti con 3d-foil. Sono disponibili nei colori: NOCE ITALIA 29 , BIANCO BR. 69, BIANCO NATUR MAT 15, NERO NATUR MAT 16, LARICE MOKA 86, LARICE SABBIA 85. La mensola legno ,sul lato visitatore, presenta motivo decorativo sottopiano realizzato in profilo di alluminio estruso nel colore CROMO SATINATO.

B) -- Cristallo: tipo Float, spessore mm 12, temperato, bordi perimetrali lavorati a filo lucido e supporti torniti in acciaio inox.

Sono disponibili nei colori: NERO 10 e BIANCO EXTRA 78 retrolaccati coprenti , oppure BIANCO SATINATO 99.

Entrambe le tipologie di mensola sono dotate di staffe metalliche per il fissaggio al pannello verticale.

### PANNELLO PORTANTE FRONTALE

Realizzato con pannello di particelle di legno spessore mm 25, nobilitato in melaminico, disponibile nei colori: BIANCO BR. 69 o NERO rifinito perimetralmente con bordo in melaminico spessore mm 0,4 in tinta con la superficie. Il pannello verticale è dotato di piedini livellatori in nylon nero ed è rivestito da fasce decorative orizzontali in legno o vetro.

### FASCE DECORATIVE ORIZZONTALI:

Sono disponibili in tre tipologie:

A) --Finitura Legno : realizzate con pannelli in MDF spessore mm 18, rivestiti con 3d-foil. Sono disponibili nei colori: NOCE ITALIA 29, ZEBRANO HIGH GLOSS 50, BIANCO HIGH GLOSS 48, NERO HIGH GLOSS 49, LARICE MOKA 86, LARICE SABBIA 85.

B) -- Cristallo: tipo Float, spessore mm 4, temperato, bordi perimetrali lavorati a filo lucido, disponibili nei colori: NERO 10 e BIANCO EXTRA 78 retrolaccati coprenti.

C) -- Policarbonato con retroilluminazione a LED: spessore mm 4, disponibili nel colore BIANCO.

Le fasce in cristallo e in policarbonato sono dotate di telaio perimetrale in alluminio estruso nel colore CROMO SATINATO.

### FIANCHI DI SOSTEGNO

Realizzati con pannello di particelle di legno spessore mm 50, rivestiti con 3d-foil. Sono disponibili nei colori: NOCE ITALIA 29, BIANCO BR. 69, BIANCO NATUR MAT 15, NERO NATUR MAT 16, ZEBRANO HIGH GLOSS 50. I bordi perimetrali sono rifiniti con profilo in alluminio estruso nel colore CROMATO SATINATO. Tutti i fianchi sono dotati di piedini livellatori in nylon nero e staffe metalliche per l'ancoraggio ai piani di lavoro.

### STORAGE

Utilizzabili come sostegno per i piani di lavoro (completi di staffe in dotazione) oppure come freestanding).

Sono disponibili in due tipologie:

- con anta dx o sx (con serratura)

- con cassetto estraibile (con serratura)

Realizzati con pannelli esterni in MDF spessore mm 18, rivestiti con 3d-foil. Sono disponibili nei colori: NOCE ITALIA 29, BIANCO BR. 69, BIANCO NATUR MAT 15, NERO NATUR MAT 16, ZEBRANO HIGH GLOSS 50.

**La versione storage con anta** è dotato di un ripiano registrabile sp. mm25 , una base e un cappello sp. mm 18, realizzati con pannelli di particelle di legno nobilitato in melaminico nel colore argento golf.

**La versione storage con cassetto estraibile** ha una struttura interna in lamiera metallica e nella parte superiore una vaschetta porta-cancelleria. Tutti gli storage sono dotati di piedini livellatori e maniglione verticale.

Gli storage sono da completare sempre con top di finitura!

### TOPS DI FINITURA PER STORAGE

Sono disponibili in due tipologie:

A) --Finitura Legno : realizzato con pannello in MDF spessore mm 18, rivestiti con 3d-foil. E' disponibile nei colori: NOCE ITALIA 29, BIANCO BR. 69, BIANCO NATUR MAT 15, NERO NATUR MAT 16, LARICE MOKA 86, LARICE SABBIA 85, ZEBRANO HIGH GLOSS 50.

B) -- Cristallo: tipo Float, spessore mm 6, temperato, bordi perimetrali lavorati a filo lucido. E' disponibile nei colori: NERO 10 e BIANCO EXTRA 78 retrolaccati coprenti.

### CASSETTIERE SU RUOTE

La struttura interna è realizzata con pannelli di particelle di legno sp. mm 18 nobilitati in melaminico colore BIANCO BR. 69 rifiniti perimetralmente con bordo melaminico sp. mm 0,4 in tinta con la superficie. Essa poggia su ruote pivottanti gemellate in nylon rivestito in gomma, con perno di supporto e rivestimento laterale cromato, freno stabilizzatore per le ruote anteriori.

Il top, fianchi finali, schiena e frontali sono realizzati con pannelli di fibre di legno tipo MDF sp. mm 18 con il lato interno nobilitato bianco e le parti a vista sono rivestite in foglia calandrata monostrato di PVC termoformabile nei colori: NOCE ITALIA 29, BIANCO BR. 69, BIANCO NATUR MAT 15, NERO NATUR MAT 16, LARICE MOKA 86, LARICE SABBIA 85, ZEBRANO HIGH GLOSS 50.

La struttura interna dei cassetti è costituita da spondine e fondo in fibra rivestiti in 3d-foil nero che scorrono su guide metalliche con cuscinetti in nylon dotati di fine corsa in apertura e self-closing in chiusura. L'apertura è senza maniglia perché le guide sono dotate di sistema premi-apri.

Le cassettiere su ruote sono dotate di porta-cancelleria estraibile posizionato all'interno del cassetto superiore, realizzato in MDF rivestito con foglia 3d-foil con scomparti per I-PAD e telefoni cellulari.

### MOBILI CONTENITORI

Sono disponibili nelle larghezze cm 45 e cm 90 ed in 3 diverse tipologie in altezza: bassi, medi e alti.

La struttura è realizzata con pannelli di particelle di legno composite decorate sp. mm 18(sp. mm 25 per i ripiani) colore BIANCO BR.69 , rifiniti perimetralmente con bordo melaminico sp. mm 0,4 in tinta con la superficie ed è dotata di piedini livellatori.

Le ante sono realizzate con pannelli di fibre di legno tipo MDF sp. mm 18 con il lato interno nobilitato bianco e le parti a vista sono rivestite in foglia calandrata monostrato di PVC termoformabile nei colori: NOCE ITALIA 29, BIANCO BR. 69, BIANCO NATUR MAT 15, NERO NATUR MAT 16, LARICE MOKA 86, LARICE SABBIA 85, ZEBRANO HIGH GLOSS 50.

Le ante legno basse e medie sono dotate di serratura a paletto, le ante alte sono dotate di serratura ad aste rotanti con 2 punti di chiusura.

Le maniglie sono metalliche con finitura cromata.

Le composizioni dei mobili sono da completare sempre con top+fianchi finali .

### TOP DI FINITURA E FIANCHI FINALI PER MOBILI BASSI, MEDI E ALTI

I tops sono realizzati con pannelli di fibre di legno tipo MDF sp. mm 18 con il lato interno nobilitato alluminio e le parti a vista sono rivestite in foglia calandrata monostrato di PVC termoformabile nei colori: NOCE ITALIA 29, BIANCO BR. 69, BIANCO NATUR MAT 15, NERO NATUR MAT 16, LARICE MOKA 86, LARICE SABBIA 85, ZEBRANO HIGH GLOSS 50.

### IMBALLO

Tutti i componenti sono forniti smontati ed imballati con involucro pieghevole in cartone triplo, listelli di protezione perimetrale e per i riempimenti ove occorre. Gli angoli sono protetti, ove occorre, con parasigoli anti-urto. La chiusura dell'imballo avviene mediante nastro adesivo e reggetta in nylon termosaldato.

CARATTERISTICHE FISICO-MECCANICHE DEI PANNELLI DI PARTICELLE DI LEGNO DI SPESSORE mm 18 NOBILITATI IN MELAMINICO:		
DESCRIZIONE	VALORE MINIMO	NORMA DI RIFERIMENTO
Massa volumica	650 Kg / m <sup>3</sup> ± 10%	UNI EN 323 :1994
Umidità relativa	5 - 13%	UNI EN 322 :1994
Tolleranza spessore	± 0,3 mm	UNI EN 324-1/1994
Rigonfiamento a 24 ore	15%	UNI EN 317 :1994
Distacco strati esterni	0,8 Mpa	UNI EN 311 :2003
Flessione statica	16 Mpa	UNI EN 310 :1994
Modulo di elasticità	1600 Mpa	UNI EN 310 :1994
Estrazione viti sui bordi	> 400 N	UNI EN 320 :1994
Contenuto di formaldeide	≤ a 3,5 mg H <sub>2</sub> CO (m <sup>2</sup> x h)	UNI EN ISO 12460 - 3:2015

Emesso da Ufficio Tecnico  
LAS MOBILI  
Data ultima revisione:  
GENNAIO 2018

# NICE

## TECHNICAL DESCRIPTION

### WORKTOPS:

Made with MDF panels mm 25 covered with 3d-foil. Available in colours: ITALY WALNUT 29, BR. WHITE 69, NATUR MAT WHITE 15, NATUR MAT BLACK 16, MOKA LARCH 86, SAND LARCH 85. The edges adjoining to the vertical panel show perforations for cables crossing. Worktops are supplied with horizontal beam of support made in rectangular metal tubular 50 x 15x thickness 1,5 painted with METALIZED SILVER epoxy powder.

### SHELVES:

Available in two types:

A) --Wood Finish: Made with MDF panels thickness mm 25, covered with 3d-foil. Available in colours: ITALY WALNUT 29, BR. WHITE 69, NATUR MAT WHITE 15, NATUR MAT BLACK 16, MOKA LARCH 86, SAND LARCH 85. The wooden shelves, on the side of the visitor, has a decorative motive undersurface made in extruded aluminum profile in the colour CHROME SATINIZED.

B) -- Cristal: type Float, thickness mm 12, tempered, edges in mat polish and support refined in stainless steel.

Available in the colours: BLACK 10 e EXTRA WHITE 78 rear lacquered covering, or SATINED WHITE 99.

Both types of shelves are provided with metal bands for fixing to the vertical panel.

### FRONT BEARING PANEL

Made with wooden particles panel thickness mm 25, melamine ennobled, available in colours: BR. WHITE 69 or BLACK perimetrically finished with melamine edge thickness mm 0,4 In the same colour of the surface. The vertical panel is provided with leveler feet in black nylon and is covered by horizontal decorative bands in wood or glass.

### HORIZONTAL DECORATIVE BANDS:

Available in three types:

A) --Wood Finish: made with MDF panels, thickness mm 18, covered with 3d-foil. Available in colours: ITALY WALNUT 29, HIGH GLOSS ZEBRAWOOD 50, HIGH GLOSS WHITE 48, HIGH GLOSS BLACK 49, MOKA LARCH 86, SAND LARCH 85.

B) ) -- Cristal: type Float, thickness mm 4, tempered, the edges in mat polish, available in colours: BLACK 10 and EXTRA WHITE 78 rear lacquered covering.

C) ) -- Polycarbonate with LED backlight: thickness mm 4, available in colour WHITE.

Cristal bands or polycarbonate bands are provided with extruded aluminum edge frame in the colour CHROME SATINIZED.

### SUPPORTING SIDE PANELS

Made with wooden particles panel thickness mm 50, covered with 3d-foil. Available in colours: ITALY WALNUT 29, BR. WHITE 69, NATUR MAT WHITE 15, NATUR MAT BLACK 16 , HIGH GLOSS ZEBRAWOOD 50.

The edges are finished with extruded aluminum profile in the colour CHROME SATINIZED.

All side panels are provided with leveler feet in black nylon and metal bands for anchorage to worktops.

### STORAGE

Can be used as support for worktops (supplied with bands) or as freestanding.

Two types available:

- with right or left door (with lock)

- with extractable drawer (with lock)

Made with external MDF panels thickness mm 18, covered with 3d-foil. Available in colours: ITALY WALNUT 29, BR. WHITE 69, NATUR MAT WHITE 15, NATUR MAT BLACK 16 , HIGH GLOSS ZEBRAWOOD 50.

**The version storage with door** is provided with adjustable shelf thickness mm 25 , one base and one hat thickness mm 18, made with wooden particles panel melamine ennobled in colour silver golf.

**The version storage with extractable drawer** has an internal sheet metal structure and on the upper part a basket for office material. All storage are provided with leveler feet and vertical handler.

The storage should always be completed with finishing top!

### FINISHING TOPS FOR STORAGE:

Available in two types:

A) --Wood Finish: Made with MDF panels thickness mm 18, covered with 3d-foil. Available in colours: ITALY WALNUT 29, BR. WHITE 69, NATUR MAT WHITE 15, NATUR MAT BLACK 16, MOKA LARCH 86, SAND LARCH 85, HIGH GLOSS ZEBRAWOOD 50.

B) -- Cristal: type Float, thickness mm 6, tempered, edges in mat polish and support refined in stainless steel. Available in the colours: BLACK 10 e EXTRA WHITE 78 rear lacquered covering.

### PEDESTALS ON WHEELS

The inside structure are made of melamine bloomed BR.WHITE 69 colour particleboard panels of 18mm thick perimetrically finished with a melamine edge of 0.4mm thick in the same colour as the surface. The structure rests on pirouetting nylon wheels covered in rubber with a supporting pin and a chromed side finish, with a stabilizer brake for the front wheels.

The tops, final side panels, back panel and frontals are made with MDF type fibreboard panels of 18mm thick with WHITE bloomed internal sides, with the outer sides covered in 3d-foil in the following colours: ITALY WALNUT 29, BR. WHITE 69, NATUR MAT WHITE 15, NATUR MAT BLACK 16, MOKA LARCH 86, SAND LARCH 85, HIGH GLOSS ZEBRAWOOD 50.

The drawers internal structure has small side fibreboard panels and base covered in white 3d-foil that slides on metal guides with nylon bearings fitted with runners for opening and self-closing in the lockup. The opening is no handle because the guides are equipped with push-open system.

The pedestals on wheels are fitted with pull-out stationery holder placed inside the upper drawer, made of MDF covered with thermoformed polymeric sheet (PVC) with compartments for I-PAD and mobile phones.

### CABINETS

Are available in the width 45cm and 90cm and in 3 different height measurements: low, medium and high cabinets.

The structure is made from 18mm thick (25mm thick for shelves) decorated wood based panels and only available in BR. WHITE 69, perimetrically finished with melamine edge of 0.4mm thick in the same colour as the surface and fitted with leveler feet.

The doors are made with MDF type fibreboard panels of 18mm thick with WHITE bloomed internal sides, with the outer sides covered in 3d-foil in the following colours: BR. WHITE 69, NATUR MAT WHITE 15, NATUR MAT BLACK 16, MOKA LARCH 86, SAND LARCH 85, HIGH GLOSS ZEBRAWOOD 50.

The low and medium wooden doors are fitted with sliding bar locks , the high doors are fitted with a rotating rod lock with 2 locking points.

The handles are made of metal with a chrome finish.

ATTENTION! The cabinets are always completed with top finish + final sides!

**FINISHING TOPS AND FINAL SIDE PANELS FOR LOW, MEDIUM AND HIGH CABINETS**

The tops are made with MDF type fibreboard panels of 18mm thick with a WHITE bloomed internal sides with the visible parts covered in 3d-foil in the following colours: BR. WHITE 69, NATUR MAT WHITE 15, NATUR MAT BLACK 16, MOKA LARCH 86, SAND LARCH 85, HIGH GLOSS ZEBRAWOOD 50.

**PACKAGING**

All components are supplied disassembled and packed with paper triple type folding packaging, fillets for the perimetrical protection and for the fillings up, where needed. The corners are protected, where needed, through shock resistant edges protector. The packing closure occurs through sticky tape and welded nylon strap.

PHYSICAL-MECHANICAL CHARACTERISTICS OF 18 MM THICK PARTICLEBOARD PANELS, MELAMINE-FACED:		
DESCRIPTION	MINIMUM VALUE	STANDARD NUMBERS
Volume Mass	650 Kg / m <sup>3</sup> ± 10%	UNI EN 323 :1994
Relative Humidity	5 - 13%	UNI EN 322 :1994
Thickness Allowance	± 0,3 mm	UNI EN 324-1/1994
24 hour Swelling	15%	UNI EN 317 :1994
External Surfaces Detachment	0,8 Mpa	UNI EN 311 :2003
Static Flexure	16 Mpa	UNI EN 310 :1994
Elastic Modulus	1600 Mpa	UNI EN 310 :1994
Edge Screws Extraction	> 400 N	UNI EN 320 :1994
Formaldehyde Content	≤ a 3,5 mg H <sub>2</sub> CO (m <sup>2</sup> x h)	UNI EN ISO 12460 - 3:2015

Released by the Technical Office  
of LAS MOBILI  
last revision date:  
JANUARY 2018

**INDICE DEI CODICI**  
codes index

\* = INDICARE IL CODICE FINITURA  
= complete with finish code

INDICE DEI CODICI / codes index  
Mod. NICE

CODICE code	DESCRIZIONE description	PAG. page	PREZZO price
115 330 *	MODULO BASE LINEARE 3 FASCE LEGNO L.80 linear base module with 3 wooden bands w 80 cms	7	€ 347,00
115 331 *	MODULO BASE LINEARE 3 FASCE LEGNO L.120 linear base module with 3 wooden bands w 120 cms	7	€ 446,00
115 332 *	MODULO BASE LINEARE 3 FASCE LEGNO L.180 linear base module with 3 wooden bands w 180 cms	7	€ 672,00
115 335 *	MODULO BASE LINEARE 2 FASCE LEGNO L.80 linear base module with 2 wooden bands w 80 cms	7	€ 313,00
115 336 *	MODULO BASE LINEARE 2 FASCE LEGNO L.120 linear base module with 2 wooden bands w 120 cms	7	€ 396,00
115 337 *	MODULO BASE LINEARE 2 FASCE LEGNO L.180 linear base module with 2 wooden bands w 180 cms	7	€ 597,00
115 339 *	MENSOLA LEGNO L.80 wooden shelves w 80 cms	14	€ 93,00
115 340 *	MENSOLA LEGNO L.120 wooden shelves w 120 cms	14	€ 137,00
115 341 *	MENSOLA LEGNO L.180 wooden shelves w 180 cms	14	€ 174,00
115 343 *	MENSOLA VETRO L.80 glass shelves w 80 cms	14	€ 215,00
115 343 478	MENSOLA VETRO L.80 glass shelves w 80 cms	14	€ 241,00
115 344 *	MENSOLA VETRO L.120 glass shelves w 120 cms	14	€ 278,00
115 344 478	MENSOLA VETRO L.120 glass shelves w 120 cms	14	€ 315,00
115 345 *	MENSOLA VETRO L.180 glass shelves w 180 cms	14	€ 381,00
115 345 478	MENSOLA VETRO L.180 glass shelves w 180 cms	14	€ 439,00
115 347 510	FASCIA SUPERIORE IN VETRO L.80 upper glass band w 80 cms	9	€ 121,00
115 347 478	FASCIA SUPERIORE IN VETRO L.80 upper glass band w 80 cms	9	€ 135,00
115 348 510	FASCIA SUPERIORE IN VETRO L.120 upper glass band w 120 cms	9	€ 154,00
115 348 478	FASCIA SUPERIORE IN VETRO L.120 upper glass band w 120 cms	9	€ 174,00
115 349 510	FASCIA SUPERIORE IN VETRO L.180 upper glass band w 180 cms	9	€ 198,00
115 349 478	FASCIA SUPERIORE IN VETRO L.180 upper glass band w 180 cms	9	€ 221,00
115 351 499	FASCIA SUPERIORE IN POLICARBONATO RETROILLUMINATO A LED L.80 upper polycarbonate band w 80 cms (back led lighting)	9	€ 219,00
115 352 499	FASCIA SUPERIORE IN POLICARBONATO RETROILLUMINATO A LED L.120 upper polycarbonate band w 120 cms (back led lighting)	9	€ 306,00
115 353 499	FASCIA SUPERIORE IN POLICARBONATO RETROILLUMINATO A LED L.180 upper polycarbonate band w 180 cms (back led lighting)	9	€ 435,00
115 367 *	MODULO CONVERSAZIONE TERMINALE DX L.180 (PER UTILIZZATORI DIVERSAMENTE ABILI) right terminal conversation module w 180 cms (for disabled people)	7	€ 609,00
115 368 *	MODULO CONVERSAZIONE TERMINALE SX L.180 (PER UTILIZZATORI DIVERSAMENTE ABILI) left terminal conversation module w 180 cms (for disabled people)	7	€ 609,00
115 369 *	MODULO BASE ANGOLARE 3 FASCE LEGNO L.70,1 x p.70,1 DX right angular base module with 3 wooden bands w 70,1 x d 70,1 cms	8	€ 495,00
115 370 *	MODULO BASE ANGOLARE 3 FASCE LEGNO L.70,1 x p.70,1 SX left angular base module with 3 wooden bands w 70,1 x d 70,1 cms	8	€ 495,00
115 371 *	MODULO BASE ANGOLARE 2 FASCE LEGNO L.70,1 x p.70,1 DX right angular base module with 2 wooden bands w 70,1 x d 70,1 cms	8	€ 435,00
115 372 *	MODULO BASE ANGOLARE 2 FASCE LEGNO L.70,1 x p.70,1 SX left angular base module with 2 wooden bands w 70,1 x d 70,1 cms	8	€ 435,00
115 375 *	COPPIA MENSOLE ANGOLARI IN LEGNO PER MODULO BASE ANGOLARE L.70,1 x p.70,1 set of 2 angular wooden shelves for angular base module w 70,1 x d 70,1 cms	14	€ 194,00
115 376 *	COPPIA MENSOLE ANGOLARI IN VETRO PER MODULO BASE ANGOLARE L.70,1 x p.70,1 set of 2 angular glass shelves for angular base module w 70,1 x d 70,1 cms	14	€ 562,00
115 376 478	COPPIA MENSOLE ANGOLARI IN VETRO PER MODULO BASE ANGOLARE L.70,1 x p.70,1 set of 2 angular glass shelves for angular base module w 70,1 x d 70,1 cms	14	€ 606,00
115 378 *	COPPIA FASCE SUPERIORI IN VETRO PER MODULO BASE ANGOLARE L.70,1 x p.70,1 set of 2 upper glass bands for angular base module w 70,1 x d 70,1 cms	9	€ 224,00
115 378 478	COPPIA FASCE SUPERIORI IN VETRO PER MODULO BASE ANGOLARE L.70,1 x p.70,1 set of 2 upper glass bands for angular base module w 70,1 x d 70,1 cms	9	€ 253,00
115 379 *	COPPIA FASCE SUPERIORI IN POLICARBONATO RETROILLUMINATO A LED PER MODULO BASE ANGOLARE L.70,1 x p.70,1 set of 2 upper polycarbonate bands for angular base module w 70,1 x d 70,1 cms (back led lighting)	9	€ 426,00
115 421 *	MODULO BASE ANGOLARE 3 FASCE LEGNO L.185,1 x p.150,1 DX right angular base module with 3 wooden bands w 185,1 x d 150,1 cms	8	€ 1.134,00
115 422 *	MODULO BASE ANGOLARE 3 FASCE LEGNO L.185,1 x p.150,1 SX left angular base module with 3 wooden bands w 185,1 x d 150,1 cms	8	€ 1.134,00
115 424 *	MODULO BASE ANGOLARE 2 FASCE LEGNO L.185,1 x p.150,1 DX right angular base module with 2 wooden bands w 185,1 x d 150,1 cms	8	€ 996,00
115 425 *	MODULO BASE ANGOLARE 2 FASCE LEGNO L.185,1 x p.150,1 SX left angular base module with 2 wooden bands w 185,1 x d 150,1 cms	8	€ 996,00
115 427 *	COPPIA MENSOLE ANGOLARI IN LEGNO PER MODULO BASE ANGOLARE L.185,1 x p.150,1 DX set of 2 angular wooden shelves for angular base module w 185,1 x d 150,1 cms (right)	14	€ 340,00
115 428 *	COPPIA MENSOLE ANGOLARI IN LEGNO PER MODULO BASE ANGOLARE L.185,1 x p.150,1 SX set of 2 angular wooden shelves for angular base module w 185,1 x d 150,1 cms (left)	14	€ 340,00
115 429 *	COPPIA MENSOLE ANGOLARI IN VETRO PER MODULO BASE ANGOLARE L.185,1 x p.150,1 DX set of 2 angular glass shelves for angular base module w 185,1 x d 150,1 cms (right)	14	€ 930,00
115 429 478	COPPIA MENSOLE ANGOLARI IN VETRO PER MODULO BASE ANGOLARE L.185,1 x p.150,1 DX set of 2 angular glass shelves for angular base module w 185,1 x d 150,1 cms (right)	14	€ 1.018,00
115 430 *	COPPIA MENSOLE ANGOLARI IN VETRO PER MODULO BASE ANGOLARE L.185,1 x p.150,1 SX set of 2 angular glass shelves for angular base module w 185,1 x d 150,1 cms (left)	14	€ 930,00
115 430 478	COPPIA MENSOLE ANGOLARI IN VETRO PER MODULO BASE ANGOLARE L.185,1 x p.150,1 SX set of 2 angular glass shelves for angular base module w 185,1 x d 150,1 cms (left)	14	€ 1.018,00
115 432 *	COPPIA FASCE SUPERIORI IN VETRO PER MODULO BASE ANGOLARE L.185,1 x p.150,1 set of 2 upper glass bands for angular base module w 185,1 x d 150,1 cms	9	€ 366,00
115 432 478	COPPIA FASCE SUPERIORI IN VETRO PER MODULO BASE ANGOLARE L.185,1 x p.150,1 set of 2 upper glass bands for angular base module w 185,1 x d 150,1 cms	9	€ 409,00
115 433 499	COPPIA FASCE SUPERIORI IN POLICARBONATO RETROILLUMINATO A LED PER MODULO BASE ANGOLARE L.185,1 x p.150,1 set of 2 upper polycarbonate bands for angular base module w 185,1 x d 150,1 cms (back led lighting)	9	€ 786,00
115 434 *	KIT PROLUNGA TRAVI PER MODULO ANGOLARE L.70,1 x p.70,1 beams extension kit for angular module w 70,1 x d 70,1	12	€ 105,00
115 435 *	FIANCO SOTTOPIANO CENTRALE central underlop panel	11	€ 139,00

\* = INDICARE IL CODICE FINITURA  
= complete with finish code

INDICE DEI CODICI / codes index  
Mod. NICE

CODICE code	DESCRIZIONE description	PAG. page	PREZZO price
115 437 *	FIANCONE TERMINALE DX right end panel	11	€ 282,00
115 438 *	FIANCONE TERMINALE SX left end panel	11	€ 282,00
115 439 *	FIANCONE SAGOMATO CENTRALE PER MODULI CONVERSAZIONE shaped central panel for conversation modules	11	€ 273,00
115 440 *	FIANCO DX PER MODULI CONVERSAZIONE TERMINALI DX right panel for right conversation modules	11	€ 231,00
115 441 *	FIANCO SX PER MODULI CONVERSAZIONE TERMINALI SX left panel for right conversation modules	11	€ 231,00
115 443 *	FIANCO TERMINALE DX PER MODULO BASE ANGOLARE L.70,1 x p.70,1 right end panel for angular base module w 70,1 x d 70,1 cms	12	€ 148,00
115 444 *	FIANCO TERMINALE SX PER MODULO BASE ANGOLARE L.70,1 x p.70,1 left end panel for angular base module w 70,1 x d 70,1 cms	12	€ 148,00
115 461 *	KIT ACCENSIONE CENTRALIZZATA SOTTOPIANO PER 1 LAMPADA LED undertop power cantralized kit for 1 led lamp	10	€ 85,00
115 462 *	KIT ACCENSIONE CENTRALIZZATA SOTTOPIANO FINO A 5 LAMPADE LED undertop power cantralized kit until 5 led lamps	10	€ 269,00
115 463 *	KIT ACCENSIONE CENTRALIZZATA SOTTOPIANO FINO A 10 LAMPADE LED undertop power cantralized kit until 10 led lamps	10	€ 425,00
115 471 *	STORAGE CON 1 ANTA LEGNO DX CON SERRATURA storage with 1 right wooden door with lock	13	€ 449,00
115 472 *	STORAGE CON 1 ANTA LEGNO SX CON SERRATURA storage with 1 left wooden door with lock	13	€ 449,00
115 474 *	STORAGE STANDARD CON SERRATURA standard storage with lock	13	€ 719,00
115 487 *	TOP IN LEGNO PER STORAGE wooden top for storage	13	€ 38,00
115 488 510	TOP IN VETRO PER STORAGE glass top for storage	13	€ 137,00
115 488 478	TOP IN VETRO PER STORAGE glass top for storage	13	€ 173,00
115 792 *	CASSETTIERA SU RUOTE 2 CASSETTI (CON 1 PORTA-CANCELLERIA INTERNO) pedestal on wheels with 2 drawers (with 1 internal stationery-tray)	17	€ 448,00
115 793 *	CASSETTIERA CLASSIFICATORE SU RUOTE (CON 1 PORTA-CANCELLERIA INTERNO) pedestal on wheels with 1 file-drawer (with 1 internal stationery-tray)	17	€ 470,00
115 952 *	MOBILE BASSO L.45 CON 1 ANTA LEGNO DX CON CHIUSURA AMMORTIZZATA E SERRATURA low cabinet w 45 cms with 1 soft-close right wooden door and lock	17	€ 166,00
115 953 *	MOBILE BASSO L.45 CON 1 ANTA LEGNO SX CON CHIUSURA AMMORTIZZATA E SERRATURA low cabinet w 45 cms with 1 soft-close left wooden door and lock	17	€ 166,00
115 954 *	MOBILE BASSO L.90 CON 2 ANTE LEGNO CON CHIUSURA AMMORTIZZATA E SERRATURA low cabinet w 90 cms with 2 soft-close wooden doors and lock	17	€ 277,00
115 955 *	MOBILE MEDIO L.45 CON 1 ANTA LEGNO DX CON CHIUSURA AMMORTIZZATA E SERRATURA medium cabinet w 45 cms with 1 soft-close right wooden door and lock	17	€ 286,00
115 956 *	MOBILE MEDIO L.45 CON 1 ANTA LEGNO SX CON CHIUSURA AMMORTIZZATA E SERRATURA medium cabinet w 45 cms with 1 soft-close left wooden door and lock	17	€ 286,00
115 957 *	MOBILE MEDIO L.90 CON 2 ANTE LEGNO CON CHIUSURA AMMORTIZZATA E SERRATURA medium cabinet w 90 cms with 2 soft-close wooden doors and lock	17	€ 476,00
115 958 *	MOBILE ALTO L.45 CON 1 ANTA LEGNO DX CON CHIUSURA AMMORTIZZATA E SERRATURA high cabinet w 45 cms with 1 soft-close right wooden door and lock	18	€ 366,00
115 959 *	MOBILE ALTO L.45 CON 1 ANTA LEGNO SX CON CHIUSURA AMMORTIZZATA E SERRATURA high cabinet w 45 cms with 1 soft-close left wooden door and lock	18	€ 366,00
115 960 *	MOBILE ALTO L.90 CON 2 ANTE LEGNO CON CHIUSURA AMMORTIZZATA E SERRATURA high cabinet w 90 cms with 2 soft-close wooden doors and lock	18	€ 594,00
115 963 *	TOP L.93,8 top w 93,8 cms	18	€ 80,00
115 964 *	TOP L.138,8 top w 138,8 cms	18	€ 114,00
115 965 *	TOP L.183,8 top w 183,8 cms	18	€ 144,00
115 966 *	TOP L.228,8 top w 228,8 cms	18	€ 181,00
115 967 *	TOP L.273,8 top w 273,8 cms	18	€ 218,00
115 968 *	FIANCHI FINALI PER MOBILI BASSI final side-panels for low cabinets	18	€ 137,00
115 969 *	FIANCHI FINALI PER MOBILI MEDI final side-panels for medium cabinets	18	€ 206,00
115 970 *	FIANCHI FINALI PER MOBILI ALTI final side-panels for high cabinets	18	€ 319,00
<b>OYO ACCESSORI / OYO accessories</b>			
175 451 *	CANALE PORTA-CAVI IN LAMIERA L.48 plate cable channel w 48 cms	16	€ 18,00
175 453 *	CANALE PORTA-CAVI IN LAMIERA L.68 plate cable channel w 68 cms	16	€ 19,00
175 456 *	CANALE PORTA-CAVI IN LAMIERA L.108 plate cable channel w 108 cms	16	€ 25,00
175 457 *	CANALE PORTA-CAVI IN LAMIERA L.128 plate cable channel w 128 cms	16	€ 31,00
175 459 *	CANALE PORTA-CAVI IN LAMIERA L.168 plate cable channel w 168 cms	16	€ 38,00
175 899 *	KIT ELETTRIF. SINGOLO CON PRESE SCHUKO E CAVO DI ALIMENTAZIONE DI MT 2,00 single electrification kit with SCHUKO sockets and power cable of w 200 cms	16	€ 86,00
175 900 *	KIT ELETTRIF. DOPIO CON PRESE SCHUKO E CAVO DI ALIMENTAZIONE DI MT 2,00 double electrification kit with SCHUKO sockets and power cable of w 200 cms	16	€ 160,00
175 901 *	KIT PROLUNGA DI MT 2,00 CON 1 PRESA ENTRATA / 1 USCITA extension kit of w 200 cms with an input-and-out-put-plug	16	€ 30,00

NICE  
reception







**LISTINO** 2018  
PRICE LIST

# LOUNGE & MEETING TABLES

(operative selection)



Certificato 04/16

### IMPORTANTE / it's very important

SULL'ORDINE INDICARE SEMPRE IL CODICE COMPLETO A 9 CIFRE  
always indicate on the order the complete 9-digit code

ESEMPIO: PER ORDINARE 1 TAVOLO **ART.473** BIANCO BR. INDICARE IL CODICE =  
example: to order 1 TABLE **ART.473** BR.WHITE indicate the code =

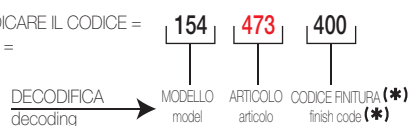

LOUNGE &  
MEETING TABLES

In vigore dal:  
Valid from:  
01/01/2018

Valido fino a nuova emissione  
Valid until new emission

**CARTELLA COLORI**  
*colours samples card*



**COD. 01**  
ARGENTO GOLF | GOLF SILVER



**COD. 06**  
NOCE PAVIA | PAVIA WALNUT



**COD. 45**  
WENGÉ | WENGÉ



**COD. 03**  
ROVERE | OAK



**COD. 42**  
GRIGIO | GREY



**COD. 58**  
ACERO TAKI | TAKI MAPLE



**COD. 04**  
ROVERE GREY | GREY OAK



**COD. 44**  
STONE GREY | STONE GREY

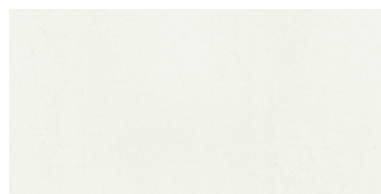

**COD. 69**  
BIANCO BR. | BR. WHITE

**N.B.: CASSETTIERE SU RUOTE, MOBILI CONTENITORI  
E LIBRERIE A SPALLA UNICA  
SONO INSERITI NEL CAPITOLO "CONTENITORI UNIVERSALI EVO"  
PLEASE NOTE: you can find pedestal on wheels, cabinet models  
and bookcases with shared side panel in the section "UNIVERSAL CABINETS EVO"**

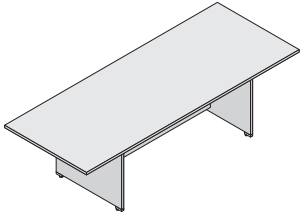
TAVOLO DA SALOTTO <i>coffee table</i>		PIANI sp. 25mm tops thick. 25mm					Mod. OXI				
DESCRIZIONE <i>description</i>	L w	CODICE <i>code</i>	KG	M <sup>3</sup>	COLLI	PREZZO <i>price</i>	(*) CODICE FINITURA <i>(*) finish code</i>				
TAVOLO DA SALOTTO L.60 <i>coffee table w 60 cms</i>    L.60 x p.60 x H.38	L.60	148 563 (*)	19	0,037	1	€ 130,00	(*) CODICE FINITURA <i>(*) finish code</i>				
							(*)	PIANO	STRUTTURA	top	structure
							003	ROVERE	ARGENTO GOLF	oak	golf silver
							025	GRIGIO	ARGENTO GOLF	grey	golf silver
							040	BIANCO BR.	ARGENTO GOLF	br. white	golf silver
							066	NOCE PAVIA	ARGENTO GOLF	pavia walnut	golf silver
							166	NOCE PAVIA	NOCE PAVIA	pavia walnut	pavia walnut
							403	ROVERE	BIANCO BR.	oak	br. white
							440	BIANCO BR.	BIANCO BR.	br. white	br. white
							466	NOCE PAVIA	BIANCO BR.	pavia walnut	br. white
							803	ROVERE	STONE GREY	oak	stone grey
							844	STONE GREY	STONE GREY	stone grey	stone grey
866	NOCE PAVIA	STONE GREY	pavia walnut	stone grey							
TAVOLI RIUNIONE BASAMENTO LEGNO <i>meeting table with panel base</i>		PIANI sp. 25mm tops thick. 25mm					Mod. OXI				
TAVOLO RIUNIONE RETTANGOLARE CON BASAMENTO LEGNO <i>rectangular meeting table with panels base</i>    L. x p.100 x H.73,6	L.210	148 566 (*)	53	0,196	3	€ 204,00	(*) CODICE FINITURA <i>(*) finish code</i>				
							(*)	PIANO	STRUTTURA	top	structure
							003	ROVERE	ARGENTO GOLF	oak	golf silver
							025	GRIGIO	ARGENTO GOLF	grey	golf silver
							040	BIANCO BR.	ARGENTO GOLF	br. white	golf silver
							066	NOCE PAVIA	ARGENTO GOLF	pavia walnut	golf silver
							166	NOCE PAVIA	NOCE PAVIA	pavia walnut	pavia walnut
							403	ROVERE	BIANCO BR.	oak	br. white
							440	BIANCO BR.	BIANCO BR.	br. white	br. white
							466	NOCE PAVIA	BIANCO BR.	pavia walnut	br. white
							803	ROVERE	STONE GREY	oak	stone grey
							844	STONE GREY	STONE GREY	stone grey	stone grey
866	NOCE PAVIA	STONE GREY	pavia walnut	stone grey							



# TAVOLI RIUNIONE BASAMENTO METALLICO

meeting table with metal base

PIANI sp. 25mm  
tops thick. 25mm

Mod. OXI

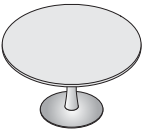
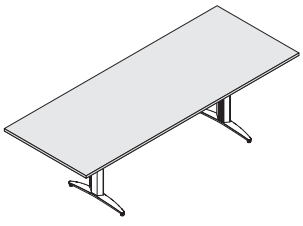
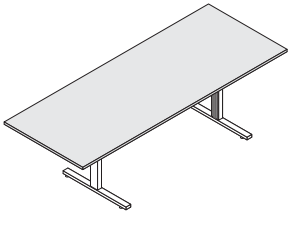
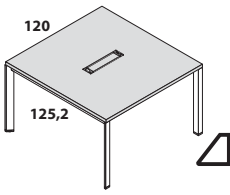
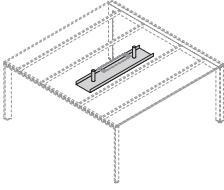
DESCRIZIONE description	L w	CODICE code	KG	M <sup>3</sup>	COLLI	PREZZO price	(*) CODICE FINITURA (*) finish code				
TAVOLO RIUNIONE CIRCOLARE CON BASAMENTO METALLICO round meeting table with metal base    Ø x H.73,6	Ø 80	148 568 (*)	29	0,108	3	€ 356,00	(*)	PIANO	GAMBA	top	leg
	Ø 100	148 569 (*)	32	0,134	3	€ 381,00	003	ROVERE	ARGENTO	oak	silver
	Ø 120	148 570 (*)	39	0,158	3	€ 403,00	025	GRIGIO	ARGENTO	grey	silver
							040	BIANCO BR.	ARGENTO	br. white	silver
TAVOLO RIUNIONE RETTANGOLARE CON GAMBE A "T" rectangular meeting table with "T" metal legs    L. x p.100 x H.73,6	L.210	148 571 (*)	41	0,226	4	€ 246,00	066	NOCE PAVIA	ARGENTO	pavia walnut	silver
	L.260	148 572 (*)	58	0,216	4	€ 289,00	403	ROVERE	BIANCO	oak	white
							440	BIANCO BR.	BIANCO	br. white	white
							466	NOCE PAVIA	BIANCO	pavia walnut	white
TAVOLO RIUNIONE RETTANGOLARE CON GAMBE A "T" rectangular meeting table with "T" metal legs    L. x p.100 x H.73,6	L.210	148 573 (*)	46	0,246	4	€ 270,00	003	ROVERE	ARGENTO	oak	silver
	L.260	148 574 (*)	63	0,236	4	€ 313,00	040	BIANCO BR.	ARGENTO	br. white	silver
							066	NOCE PAVIA	ARGENTO	pavia walnut	silver
							403	ROVERE	BIANCO	oak	white
TAVOLO RIUNIONE L.120 x p.125,2 CON TOP ACCESS meeting table w 120 x d 125,2 cms with top access    L.120 x p.125,2 x H.73,6	L.120	148 575 (*)	49	0,184	4	€ 426,00	440	BIANCO BR.	BIANCO	br. white	white
							466	NOCE PAVIA	BIANCO	pavia walnut	white
VASCHETTA CENTRALE PASSACAVI PER TAVOLO RIUNIONE ART.575 central cable tray for meeting tables ART.575    L.90 x p.20 x H.10	L.90	148 576 (*)	1,5	0,013	1	€ 54,00	(*)				
							000	ARGENTO		silver	
							440	BIANCO		white	



# TAVOLI RIUNIONE

meeting tables

PIANI sp. 25mm  
tops thick. 25mm

Mod. LOGIC

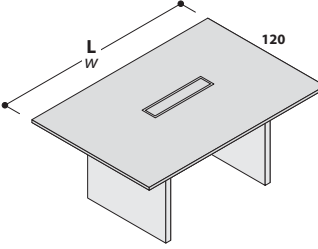
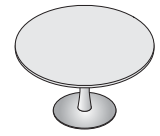
DESCRIZIONE description	L w	CODICE code	KG	M <sup>3</sup>	COLLI	PREZZO price	(*) CODICE FINITURA (*) finish code																				
TAVOLO RIUNIONE RETTANGOLARE rectangular meeting table    L x p.120 x H.72	<b>CON PASSACAVO</b> with wire-manager																										
	L.180	154 <b>598</b> (*)	76	0,221	4	€ 531,00																					
	L.240	154 <b>599</b> (*)	94	0,248	4	€ 600,00																					
TAVOLO RIUNIONE CIRCOLARE Ø 120 rounded meeting table Ø 120 cms    Ø 120 x H.72							<table border="1"> <thead> <tr> <th>(*)</th> <th>PIANO</th> <th>BORDO E BASAMENTO</th> <th>top</th> <th>edge and base</th> </tr> </thead> <tbody> <tr> <td>400</td> <td>BIANCO BR.</td> <td>BIANCO BR.</td> <td>br. white</td> <td>br. white</td> </tr> <tr> <td>403</td> <td>ROVERE</td> <td>BIANCO BR.</td> <td>oak</td> <td>br. white</td> </tr> <tr> <td>466</td> <td>NOCE PAVIA</td> <td>BIANCO BR.</td> <td>pavia walnut</td> <td>br. white</td> </tr> </tbody> </table>	(*)	PIANO	BORDO E BASAMENTO	top	edge and base	400	BIANCO BR.	BIANCO BR.	br. white	br. white	403	ROVERE	BIANCO BR.	oak	br. white	466	NOCE PAVIA	BIANCO BR.	pavia walnut	br. white
	(*)	PIANO	BORDO E BASAMENTO	top	edge and base																						
	400	BIANCO BR.	BIANCO BR.	br. white	br. white																						
403	ROVERE	BIANCO BR.	oak	br. white																							
466	NOCE PAVIA	BIANCO BR.	pavia walnut	br. white																							
Ø120	154 <b>473</b> (*)	39	0,158	3	€ 414,00																						

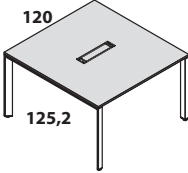
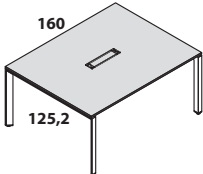

**TAVOLI RIUNIONE (PIANI SP.18 MM)**
*meeting tables (tops thick.18 mm)*
**Mod. 5TH ELEMENT**

DESCRIZIONE <i>description</i>	L <i>w</i>	CODICE <i>code</i>	KG 	M <sup>3</sup> 	COLLI 	PREZZO <i>price</i>	PREZZO <i>price</i>	(*) CODICE FINITURA <i>(*) finish code</i>																																																																																																																																											
TAVOLI RIUNIONE L.120 x p.125,2 <i>meeting table w 120 x d 125,2 cms</i>    L.120 x p.125,2 x H.72,8	L.120	153 180 (*)	46	0,261	5	€ 500,00	€ 954,00	<input checked="" type="radio"/> <b>GAMBE VERNICIATE</b> ★ <i>painted legs</i>	<input type="radio"/> <b>GAMBE CROMATE</b> ○ <i>chromed legs</i>																																																																																																																																										
								<input checked="" type="radio"/> <b>GAMBE VERNICIATE / painted legs</b>		<table border="1"> <thead> <tr> <th>(*)</th> <th>PIANO</th> <th>STRUTTURA</th> <th>top</th> <th>structure</th> </tr> </thead> <tbody> <tr><td>003</td><td>ROVERE</td><td>ARGENTO</td><td>oak</td><td>silver</td></tr> <tr><td>004</td><td>ROVERE GREY</td><td>ARGENTO</td><td>grey oak</td><td>silver</td></tr> <tr><td>020</td><td>ACERO TAKI</td><td>ARGENTO</td><td>taki maple</td><td>silver</td></tr> <tr><td>040</td><td>BIANCO BR.</td><td>ARGENTO</td><td>br. white</td><td>silver</td></tr> <tr><td>044</td><td>STONE GREY</td><td>ARGENTO</td><td>stone grey</td><td>silver</td></tr> <tr><td>066</td><td>NOCE PAVIA</td><td>ARGENTO</td><td>pavia walnut</td><td>silver</td></tr> <tr><td>090</td><td>WENGÈ</td><td>ARGENTO</td><td>wengè</td><td>silver</td></tr> <tr><td>400</td><td>BIANCO BR.</td><td>BIANCO</td><td>br. white</td><td>white</td></tr> <tr><td>403</td><td>ROVERE</td><td>BIANCO</td><td>oak</td><td>white</td></tr> <tr><td>404</td><td>ROVERE GREY</td><td>BIANCO</td><td>grey oak</td><td>white</td></tr> <tr><td>420</td><td>ACERO TAKI</td><td>BIANCO</td><td>taki maple</td><td>white</td></tr> <tr><td>444</td><td>STONE GREY</td><td>BIANCO</td><td>stone grey</td><td>white</td></tr> <tr><td>466</td><td>NOCE PAVIA</td><td>BIANCO</td><td>pavia walnut</td><td>white</td></tr> <tr><td>490</td><td>WENGÈ</td><td>BIANCO</td><td>wengè</td><td>white</td></tr> <tr><td>503</td><td>ROVERE</td><td>ANTRACITE</td><td>oak</td><td>anthracite</td></tr> <tr><td>504</td><td>ROVERE GREY</td><td>ANTRACITE</td><td>grey oak</td><td>anthracite</td></tr> <tr><td>521</td><td>ACERO TAKI</td><td>ANTRACITE</td><td>taki maple</td><td>anthracite</td></tr> <tr><td>541</td><td>BIANCO BR.</td><td>ANTRACITE</td><td>br. white</td><td>anthracite</td></tr> <tr><td>544</td><td>STONE GREY</td><td>ANTRACITE</td><td>stone grey</td><td>anthracite</td></tr> <tr><td>566</td><td>NOCE PAVIA</td><td>ANTRACITE</td><td>pavia walnut</td><td>anthracite</td></tr> <tr><td>591</td><td>WENGÈ</td><td>ANTRACITE</td><td>wengè</td><td>anthracite</td></tr> <tr><td>803</td><td>ROVERE</td><td>STONE GREY</td><td>oak</td><td>stone grey</td></tr> <tr><td>804</td><td>ROVERE GREY</td><td>STONE GREY</td><td>grey oak</td><td>stone grey</td></tr> <tr><td>820</td><td>ACERO TAKI</td><td>STONE GREY</td><td>taki maple</td><td>stone grey</td></tr> <tr><td>840</td><td>BIANCO BR.</td><td>STONE GREY</td><td>br. white</td><td>stone grey</td></tr> <tr><td>844</td><td>STONE GREY</td><td>STONE GREY</td><td>stone grey</td><td>stone grey</td></tr> <tr><td>866</td><td>NOCE PAVIA</td><td>STONE GREY</td><td>pavia walnut</td><td>stone grey</td></tr> <tr><td>890</td><td>WENGÈ</td><td>STONE GREY</td><td>wengè</td><td>stone grey</td></tr> </tbody> </table>	(*)	PIANO	STRUTTURA	top	structure	003	ROVERE	ARGENTO	oak	silver	004	ROVERE GREY	ARGENTO	grey oak	silver	020	ACERO TAKI	ARGENTO	taki maple	silver	040	BIANCO BR.	ARGENTO	br. white	silver	044	STONE GREY	ARGENTO	stone grey	silver	066	NOCE PAVIA	ARGENTO	pavia walnut	silver	090	WENGÈ	ARGENTO	wengè	silver	400	BIANCO BR.	BIANCO	br. white	white	403	ROVERE	BIANCO	oak	white	404	ROVERE GREY	BIANCO	grey oak	white	420	ACERO TAKI	BIANCO	taki maple	white	444	STONE GREY	BIANCO	stone grey	white	466	NOCE PAVIA	BIANCO	pavia walnut	white	490	WENGÈ	BIANCO	wengè	white	503	ROVERE	ANTRACITE	oak	anthracite	504	ROVERE GREY	ANTRACITE	grey oak	anthracite	521	ACERO TAKI	ANTRACITE	taki maple	anthracite	541	BIANCO BR.	ANTRACITE	br. white	anthracite	544	STONE GREY	ANTRACITE	stone grey	anthracite	566	NOCE PAVIA	ANTRACITE	pavia walnut	anthracite	591	WENGÈ	ANTRACITE	wengè	anthracite	803	ROVERE	STONE GREY	oak	stone grey	804	ROVERE GREY	STONE GREY	grey oak	stone grey	820	ACERO TAKI	STONE GREY	taki maple	stone grey	840	BIANCO BR.	STONE GREY	br. white	stone grey	844	STONE GREY	STONE GREY	stone grey	stone grey	866	NOCE PAVIA
(*)	PIANO	STRUTTURA	top	structure																																																																																																																																															
003	ROVERE	ARGENTO	oak	silver																																																																																																																																															
004	ROVERE GREY	ARGENTO	grey oak	silver																																																																																																																																															
020	ACERO TAKI	ARGENTO	taki maple	silver																																																																																																																																															
040	BIANCO BR.	ARGENTO	br. white	silver																																																																																																																																															
044	STONE GREY	ARGENTO	stone grey	silver																																																																																																																																															
066	NOCE PAVIA	ARGENTO	pavia walnut	silver																																																																																																																																															
090	WENGÈ	ARGENTO	wengè	silver																																																																																																																																															
400	BIANCO BR.	BIANCO	br. white	white																																																																																																																																															
403	ROVERE	BIANCO	oak	white																																																																																																																																															
404	ROVERE GREY	BIANCO	grey oak	white																																																																																																																																															
420	ACERO TAKI	BIANCO	taki maple	white																																																																																																																																															
444	STONE GREY	BIANCO	stone grey	white																																																																																																																																															
466	NOCE PAVIA	BIANCO	pavia walnut	white																																																																																																																																															
490	WENGÈ	BIANCO	wengè	white																																																																																																																																															
503	ROVERE	ANTRACITE	oak	anthracite																																																																																																																																															
504	ROVERE GREY	ANTRACITE	grey oak	anthracite																																																																																																																																															
521	ACERO TAKI	ANTRACITE	taki maple	anthracite																																																																																																																																															
541	BIANCO BR.	ANTRACITE	br. white	anthracite																																																																																																																																															
544	STONE GREY	ANTRACITE	stone grey	anthracite																																																																																																																																															
566	NOCE PAVIA	ANTRACITE	pavia walnut	anthracite																																																																																																																																															
591	WENGÈ	ANTRACITE	wengè	anthracite																																																																																																																																															
803	ROVERE	STONE GREY	oak	stone grey																																																																																																																																															
804	ROVERE GREY	STONE GREY	grey oak	stone grey																																																																																																																																															
820	ACERO TAKI	STONE GREY	taki maple	stone grey																																																																																																																																															
840	BIANCO BR.	STONE GREY	br. white	stone grey																																																																																																																																															
844	STONE GREY	STONE GREY	stone grey	stone grey																																																																																																																																															
866	NOCE PAVIA	STONE GREY	pavia walnut	stone grey																																																																																																																																															
890	WENGÈ	STONE GREY	wengè	stone grey																																																																																																																																															
TAVOLO RIUNIONE L.160 x p.125,2 <i>meeting table w 160 x d 125,2 cms</i>    L.160 x p.125,2 x H.72,8	L.160	153 194 (*)	54	0,293	5	€ 550,00	€ 1.004,00	<input type="radio"/> <b>GAMBE CROMATE</b> ○ <i>chromed legs</i>																																																																																																																																											
								<table border="1"> <tbody> <tr><td>903</td><td>ROVERE</td><td>CROMATO</td><td>oak</td><td>chromed</td></tr> <tr><td>904</td><td>ROVERE GREY</td><td>CROMATO</td><td>grey oak</td><td>chromed</td></tr> <tr><td>920</td><td>ACERO TAKI</td><td>CROMATO</td><td>taki maple</td><td>chromed</td></tr> <tr><td>940</td><td>BIANCO BR.</td><td>CROMATO</td><td>br. white</td><td>chromed</td></tr> <tr><td>944</td><td>STONE GREY</td><td>CROMATO</td><td>stone grey</td><td>chromed</td></tr> <tr><td>966</td><td>NOCE PAVIA</td><td>CROMATO</td><td>pavia walnut</td><td>chromed</td></tr> <tr><td>990</td><td>WENGÈ</td><td>CROMATO</td><td>wengè</td><td>chromed</td></tr> </tbody> </table>	903	ROVERE	CROMATO	oak	chromed	904	ROVERE GREY	CROMATO	grey oak	chromed	920	ACERO TAKI	CROMATO	taki maple	chromed	940	BIANCO BR.	CROMATO	br. white	chromed	944	STONE GREY	CROMATO	stone grey	chromed	966	NOCE PAVIA	CROMATO	pavia walnut	chromed	990	WENGÈ	CROMATO	wengè	chromed																																																																																																								
903	ROVERE	CROMATO	oak	chromed																																																																																																																																															
904	ROVERE GREY	CROMATO	grey oak	chromed																																																																																																																																															
920	ACERO TAKI	CROMATO	taki maple	chromed																																																																																																																																															
940	BIANCO BR.	CROMATO	br. white	chromed																																																																																																																																															
944	STONE GREY	CROMATO	stone grey	chromed																																																																																																																																															
966	NOCE PAVIA	CROMATO	pavia walnut	chromed																																																																																																																																															
990	WENGÈ	CROMATO	wengè	chromed																																																																																																																																															



# TAVOLI RIUNIONE (PIANI SP.18 MM)

meeting tables (tops thick. 18 mm)

# Mod. 5TH ELEMENT

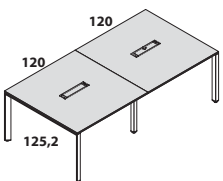
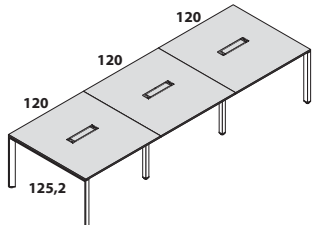
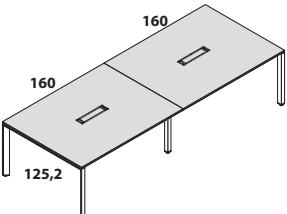
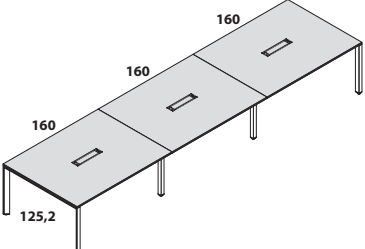
DESCRIZIONE description	L w	CODICE code	KG	M <sup>3</sup>	COLLI	PREZZO price	(*) CODICE FINITURA (*) finish code																																																																																																																																																	
TAVOLO RIUNIONE L.240 x p.125,2 meeting table w 240 x d 125,2 cms    L.240 x p.125,2 x H.72,8	L.240	153 <b>136</b> (*)	81	0,477	9	€ 850,00																																																																																																																																																		
								<b>GAMBE VERNICIATE</b> ★ painted legs																																																																																																																																																
								PER KIT WIRE-MANAGER VEDI ART. 738 A PAGINA SEGUENTE for wire-manager kit , please see art.738 to next page																																																																																																																																																
TAVOLO RIUNIONE L.360 x p.125,2 meeting table w 360 x d 125,2 cms    L.360 x p.125,2 x H.72,8	L.360	153 <b>137</b> (*)	116	0,692	13	€ 1.200,00																																																																																																																																																		
								<b>GAMBE VERNICIATE / painted legs</b>																																																																																																																																																
								PER KIT WIRE-MANAGER VEDI ART. 738 A PAGINA SEGUENTE for wire-manager kit , please see art.738 to next page																																																																																																																																																
TAVOLO RIUNIONE L.320 x p.125,2 meeting table w 320 x d 125,2 cms    L.320 x p.125,2 x H.72,8	L.320	153 <b>181</b> (*)	97	0,540	9	€ 950,00																																																																																																																																																		
								<b>GAMBE VERNICIATE / painted legs</b>																																																																																																																																																
								PER KIT WIRE-MANAGER VEDI ART. 738 A PAGINA SEGUENTE for wire-manager kit , please see art.738 to next page																																																																																																																																																
TAVOLO RIUNIONE L.480 x p.125,2 meeting table w 480 x d 125,2 cms    L.480 x p.125,2 x H.72,8	L.480	153 <b>182</b> (*)	140	0,788	13	€ 1.350,00																																																																																																																																																		
								<b>GAMBE VERNICIATE / painted legs</b>																																																																																																																																																
								PER KIT WIRE-MANAGER VEDI ART. 738 A PAGINA SEGUENTE for wire-manager kit , please see art.738 to next page																																																																																																																																																
<table border="1"> <thead> <tr> <th>(*)</th> <th>PIANO</th> <th>STRUTTURA</th> <th>top</th> <th>structure</th> </tr> </thead> <tbody> <tr><td>003</td><td>ROVERE</td><td>ARGENTO</td><td>oak</td><td>silver</td></tr> <tr><td>004</td><td>ROVERE GREY</td><td>ARGENTO</td><td>grey oak</td><td>silver</td></tr> <tr><td>020</td><td>ACERO TAKI</td><td>ARGENTO</td><td>taki maple</td><td>silver</td></tr> <tr><td>040</td><td>BIANCO BR.</td><td>ARGENTO</td><td>br. white</td><td>silver</td></tr> <tr><td>044</td><td>STONE GREY</td><td>ARGENTO</td><td>stone grey</td><td>silver</td></tr> <tr><td>066</td><td>NOCE PAVIA</td><td>ARGENTO</td><td>pavia walnut</td><td>silver</td></tr> <tr><td>090</td><td>WENGÈ</td><td>ARGENTO</td><td>wengè</td><td>silver</td></tr> <tr><td>400</td><td>BIANCO BR.</td><td>BIANCO</td><td>br. white</td><td>white</td></tr> <tr><td>403</td><td>ROVERE</td><td>BIANCO</td><td>oak</td><td>white</td></tr> <tr><td>404</td><td>ROVERE GREY</td><td>BIANCO</td><td>grey oak</td><td>white</td></tr> <tr><td>420</td><td>ACERO TAKI</td><td>BIANCO</td><td>taki maple</td><td>white</td></tr> <tr><td>444</td><td>STONE GREY</td><td>BIANCO</td><td>stone grey</td><td>white</td></tr> <tr><td>466</td><td>NOCE PAVIA</td><td>BIANCO</td><td>pavia walnut</td><td>white</td></tr> <tr><td>490</td><td>WENGÈ</td><td>BIANCO</td><td>wengè</td><td>white</td></tr> <tr><td>503</td><td>ROVERE</td><td>ANTRACITE</td><td>oak</td><td>anthracite</td></tr> <tr><td>504</td><td>ROVERE GREY</td><td>ANTRACITE</td><td>grey oak</td><td>anthracite</td></tr> <tr><td>521</td><td>ACERO TAKI</td><td>ANTRACITE</td><td>taki maple</td><td>anthracite</td></tr> <tr><td>541</td><td>BIANCO BR.</td><td>ANTRACITE</td><td>br. white</td><td>anthracite</td></tr> <tr><td>544</td><td>STONE GREY</td><td>ANTRACITE</td><td>stone grey</td><td>anthracite</td></tr> <tr><td>566</td><td>NOCE PAVIA</td><td>ANTRACITE</td><td>pavia walnut</td><td>anthracite</td></tr> <tr><td>591</td><td>WENGÈ</td><td>ANTRACITE</td><td>wengè</td><td>anthracite</td></tr> <tr><td>803</td><td>ROVERE</td><td>STONE GREY</td><td>oak</td><td>stone grey</td></tr> <tr><td>804</td><td>ROVERE GREY</td><td>STONE GREY</td><td>grey oak</td><td>stone grey</td></tr> <tr><td>820</td><td>ACERO TAKI</td><td>STONE GREY</td><td>taki maple</td><td>stone grey</td></tr> <tr><td>840</td><td>BIANCO BR.</td><td>STONE GREY</td><td>br. white</td><td>stone grey</td></tr> <tr><td>844</td><td>STONE GREY</td><td>STONE GREY</td><td>stone grey</td><td>stone grey</td></tr> <tr><td>866</td><td>NOCE PAVIA</td><td>STONE GREY</td><td>pavia walnut</td><td>stone grey</td></tr> <tr><td>890</td><td>WENGÈ</td><td>STONE GREY</td><td>wengè</td><td>stone grey</td></tr> </tbody> </table>								(*)	PIANO	STRUTTURA	top	structure	003	ROVERE	ARGENTO	oak	silver	004	ROVERE GREY	ARGENTO	grey oak	silver	020	ACERO TAKI	ARGENTO	taki maple	silver	040	BIANCO BR.	ARGENTO	br. white	silver	044	STONE GREY	ARGENTO	stone grey	silver	066	NOCE PAVIA	ARGENTO	pavia walnut	silver	090	WENGÈ	ARGENTO	wengè	silver	400	BIANCO BR.	BIANCO	br. white	white	403	ROVERE	BIANCO	oak	white	404	ROVERE GREY	BIANCO	grey oak	white	420	ACERO TAKI	BIANCO	taki maple	white	444	STONE GREY	BIANCO	stone grey	white	466	NOCE PAVIA	BIANCO	pavia walnut	white	490	WENGÈ	BIANCO	wengè	white	503	ROVERE	ANTRACITE	oak	anthracite	504	ROVERE GREY	ANTRACITE	grey oak	anthracite	521	ACERO TAKI	ANTRACITE	taki maple	anthracite	541	BIANCO BR.	ANTRACITE	br. white	anthracite	544	STONE GREY	ANTRACITE	stone grey	anthracite	566	NOCE PAVIA	ANTRACITE	pavia walnut	anthracite	591	WENGÈ	ANTRACITE	wengè	anthracite	803	ROVERE	STONE GREY	oak	stone grey	804	ROVERE GREY	STONE GREY	grey oak	stone grey	820	ACERO TAKI	STONE GREY	taki maple	stone grey	840	BIANCO BR.	STONE GREY	br. white	stone grey	844	STONE GREY	STONE GREY	stone grey	stone grey	866	NOCE PAVIA	STONE GREY	pavia walnut	stone grey	890	WENGÈ	STONE GREY	wengè	stone grey
(*)	PIANO	STRUTTURA	top	structure																																																																																																																																																				
003	ROVERE	ARGENTO	oak	silver																																																																																																																																																				
004	ROVERE GREY	ARGENTO	grey oak	silver																																																																																																																																																				
020	ACERO TAKI	ARGENTO	taki maple	silver																																																																																																																																																				
040	BIANCO BR.	ARGENTO	br. white	silver																																																																																																																																																				
044	STONE GREY	ARGENTO	stone grey	silver																																																																																																																																																				
066	NOCE PAVIA	ARGENTO	pavia walnut	silver																																																																																																																																																				
090	WENGÈ	ARGENTO	wengè	silver																																																																																																																																																				
400	BIANCO BR.	BIANCO	br. white	white																																																																																																																																																				
403	ROVERE	BIANCO	oak	white																																																																																																																																																				
404	ROVERE GREY	BIANCO	grey oak	white																																																																																																																																																				
420	ACERO TAKI	BIANCO	taki maple	white																																																																																																																																																				
444	STONE GREY	BIANCO	stone grey	white																																																																																																																																																				
466	NOCE PAVIA	BIANCO	pavia walnut	white																																																																																																																																																				
490	WENGÈ	BIANCO	wengè	white																																																																																																																																																				
503	ROVERE	ANTRACITE	oak	anthracite																																																																																																																																																				
504	ROVERE GREY	ANTRACITE	grey oak	anthracite																																																																																																																																																				
521	ACERO TAKI	ANTRACITE	taki maple	anthracite																																																																																																																																																				
541	BIANCO BR.	ANTRACITE	br. white	anthracite																																																																																																																																																				
544	STONE GREY	ANTRACITE	stone grey	anthracite																																																																																																																																																				
566	NOCE PAVIA	ANTRACITE	pavia walnut	anthracite																																																																																																																																																				
591	WENGÈ	ANTRACITE	wengè	anthracite																																																																																																																																																				
803	ROVERE	STONE GREY	oak	stone grey																																																																																																																																																				
804	ROVERE GREY	STONE GREY	grey oak	stone grey																																																																																																																																																				
820	ACERO TAKI	STONE GREY	taki maple	stone grey																																																																																																																																																				
840	BIANCO BR.	STONE GREY	br. white	stone grey																																																																																																																																																				
844	STONE GREY	STONE GREY	stone grey	stone grey																																																																																																																																																				
866	NOCE PAVIA	STONE GREY	pavia walnut	stone grey																																																																																																																																																				
890	WENGÈ	STONE GREY	wengè	stone grey																																																																																																																																																				

LOUNGE & MEETING TABLES

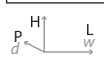

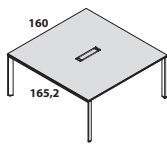
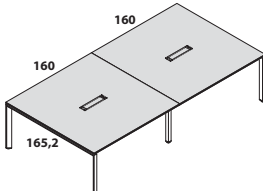
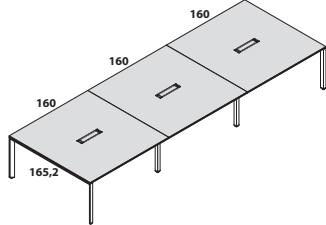
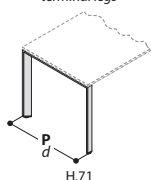
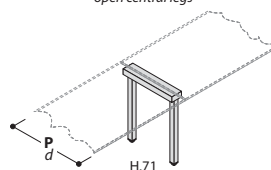
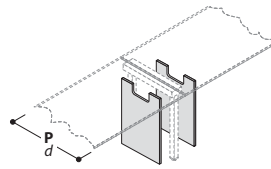
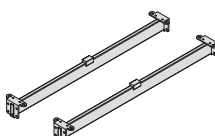
TAVOLI RIUNIONE (PIANI SP.18 MM) meeting tables (tops thick. 18 mm)							Mod. 5TH ELEMENT				
DESCRIZIONE description	L w	CODICE code	KG	M <sup>3</sup>	COLLI	PREZZO price	(*) CODICE FINITURA (*) finish code				
TAVOLO RIUNIONE L.160 x p.165,2 meeting table w 160 x d 165,2 cms    L.160 x p.165,2 x H.72,8	L.160	153 185 (*)	58	0,361	5	€ 625,00	<b>GAMBE VERNICIATE</b> ★ painted legs				
							<b>★ GAMBE VERNICIATE / painted legs</b>				
TAVOLO RIUNIONE L.320 x p.165,2 meeting table w 320 x d 165,2 cms    L.320 x p.165,2 x H.72,8	L.320	153 186 (*)	105	0,676	9	€ 1.066,00	<b>PER KIT WIRE-MANAGER VEDI ART. 739 IN BASSO</b> <i>for wire-manager kit, please see art.739 to below page</i>				
							<b>PER KIT WIRE-MANAGER VEDI ART. 739 IN BASSO</b> <i>for wire-manager kit, please see art.739 to below page</i>				
TAVOLO RIUNIONE L.480 x p.165,2 meeting table w 480 x d 165,2    L.480 x p.165,2 x H.72,8	L.480	153 187 (*)	152	0,991	13	€ 1.507,00	<b>PER KIT WIRE-MANAGER VEDI ART. 739 IN BASSO</b> <i>for wire-manager kit, please see art.739 to below page</i>				
							<b>PER KIT WIRE-MANAGER VEDI ART. 739 IN BASSO</b> <i>for wire-manager kit, please see art.739 to below page</i>				
							<b>(*) CODICE FINITURA</b> (*) finish code				
							<b>★ GAMBE VERNICIATE / painted legs</b>				
							(*)	PIANO	STRUTTURA	top	structure
							003	ROVERE	ARGENTO	oak	silver
							004	ROVERE GREY	ARGENTO	grey oak	silver
							020	ACERO TAKI	ARGENTO	taki maple	silver
							040	BIANCO BR.	ARGENTO	br. white	silver
							044	STONE GREY	ARGENTO	stone grey	silver
							066	NOCE PAVIA	ARGENTO	pavia walnut	silver
							090	WENGÈ	ARGENTO	wengè	silver
							400	BIANCO BR.	BIANCO	br. white	white
							403	ROVERE	BIANCO	oak	white
							404	ROVERE GREY	BIANCO	grey oak	white
							420	ACERO TAKI	BIANCO	taki maple	white
							444	STONE GREY	BIANCO	stone grey	white
							466	NOCE PAVIA	BIANCO	pavia walnut	white
							490	WENGÈ	BIANCO	wengè	white
							503	ROVERE	ANTRACITE	oak	anthracite
							504	ROVERE GREY	ANTRACITE	grey oak	anthracite
							521	ACERO TAKI	ANTRACITE	taki maple	anthracite
							541	BIANCO BR.	ANTRACITE	br. white	anthracite
							544	STONE GREY	ANTRACITE	stone grey	anthracite
							566	NOCE PAVIA	ANTRACITE	pavia walnut	anthracite
							591	WENGÈ	ANTRACITE	wengè	anthracite
							803	ROVERE	STONE GREY	oak	stone grey
							804	ROVERE GREY	STONE GREY	grey oak	stone grey
							820	ACERO TAKI	STONE GREY	taki maple	stone grey
							840	BIANCO BR.	STONE GREY	br. white	stone grey
							844	STONE GREY	STONE GREY	stone grey	stone grey
							866	NOCE PAVIA	STONE GREY	pavia walnut	stone grey
							890	WENGÈ	STONE GREY	wengè	stone grey
<b>GAMBE METALLICHE A PONTE E TRAVI DI SUPPORTO</b> bridge metal legs and support beams											
GAMBE TERMINALI terminal legs    H.71	p.125	153 702 (*)	11	0,077	1	€ 128,00					
	p.165	153 703 (*)	13	0,098	1	€ 152,00					
GAMBE CENTRALI APERTE open central legs    H.71	p.125	153 708 (*)	11	0,108	1	€ 106,00	<b>(*)</b>				
	p.165	153 709 (*)	15	0,149	1	€ 120,00	000	ARGENTO		silver	
KIT WIRE-MANAGER PER GAMBA A PONTE CENTRALE wire-manager kit for central bridge leg    H.71	p.125	153 738 (*)	10	0,046	1	€ 117,00	400	BIANCO BR.		br. white	
	p.165	153 739 (*)	12	0,068	1	€ 119,00	551	ANTRACITE		anthracite	
COPPIA DI TRAVI PER GAMBE A PONTE set of 2 beams for bridge legs  	L.120	153 721 (*)	3	0,021	1	€ 68,00	844	STONE GREY		stone grey	
	L.160	153 723 (*)	5	0,027	1	€ 81,00	(*)				
							000	ARGENTO		silver	





## PIANI TAVOLI RIUNIONE (PIANI SP.18 MM)

meeting tables tops (tops thick.18 mm)

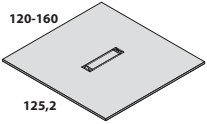
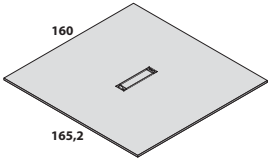
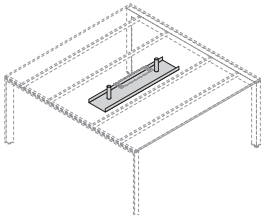
DESCRIZIONE description	L w	CODICE code	KG	M <sup>3</sup>	COLLI	PREZZO price	(*) CODICE FINITURA (*) finish code							
PIANI TAVOLI RIUNIONE PROF. CM 125,2 meeting table tops deep 125,2 cms   L. x p.125,2 x H.1,8	<b>SENZA TOP ACCESS</b> without top access													
	L.120	153 <b>536</b> (*)	18	0,064	1	€ 83,00								
	L.160	153 <b>539</b> (*)	22	0,085	1	€ 107,00								
	<b>CON TOP ACCESS</b> with top access													
	L.120	153 <b>826</b> (*)	18	0,064	1	€ 108,00	(*)							
	L.160	153 <b>825</b> (*)	22	0,085	1	€ 132,00								
PIANO TAVOLO RIUNIONE PROF. CM 165,2 meeting table tops deep 165,2 cms   L. x p.165,2 x H.1,8	<b>SENZA TOP ACCESS</b> without top access													
	L.160	153 <b>543</b> (*)	22	0,111	1	€ 137,00								
	<b>CON TOP ACCESS</b> with top access													
	L.160	153 <b>827</b> (*)	22	0,111	1	€ 159,00								
	VASCHEE CENTRALI PASSACAVI <b>PER TAVOLI RIUNIONE</b> central cable trays for meeting tables   L. x p.20 x H.10	L.90	153 <b>241</b> (*)	2	0,013	1	€ 54,00							
		L.121	153 <b>243</b> (*)	3	0,023	1	€ 61,00							
PROSPETTO INFORMATIVO fact-sheet <table border="1" style="margin-left: auto; margin-right: auto;"> <tr> <td>VASCHEE CENTRALI</td> <td>UTILIZZABILE SU PIANI</td> </tr> <tr> <td>central cable tray</td> <td>usable on the meeting table tops</td> </tr> <tr> <td>ART.241</td> <td>L.120</td> </tr> <tr> <td>ART.243</td> <td>L.160</td> </tr> </table>							VASCHEE CENTRALI	UTILIZZABILE SU PIANI	central cable tray	usable on the meeting table tops	ART.241	L.120	ART.243	L.160
VASCHEE CENTRALI	UTILIZZABILE SU PIANI													
central cable tray	usable on the meeting table tops													
ART.241	L.120													
ART.243	L.160													
							(*)							
							000 ARGENTO silver							

**PER SOSTENERE I PIANI UTILIZZARE LA STRUTTURA METALLICA A PONTE**  
 use the bridge metal structure to support the meeting table tops

ESEMPIO:  
example:

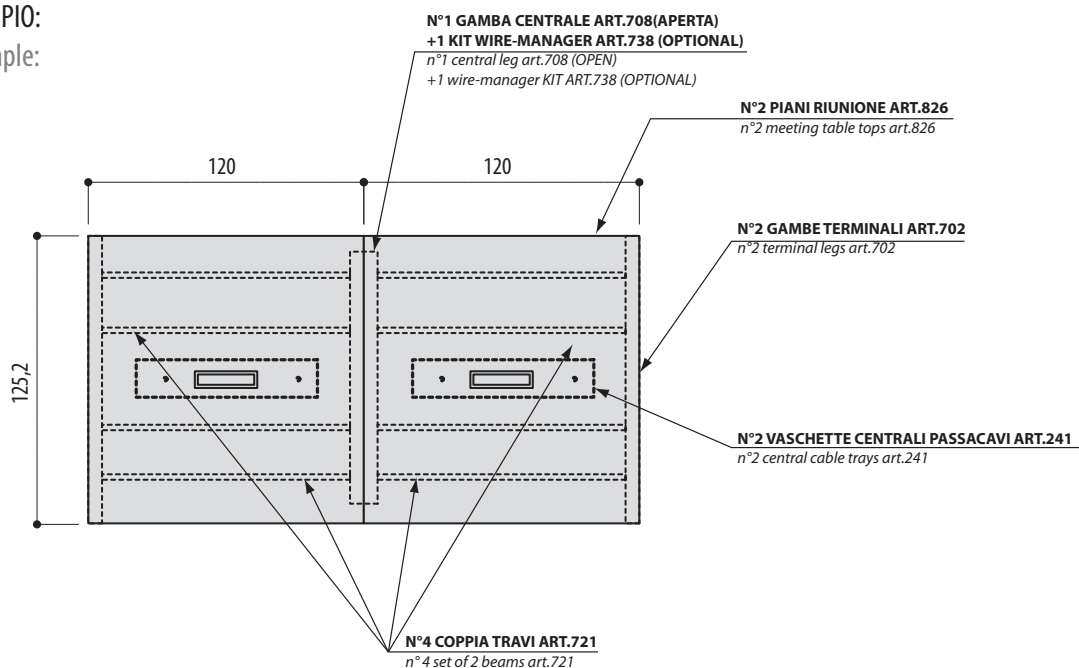

LOUNGE & MEETING TABLES

# TAVOLI TEAM (PIANI SP.18 MM)

team tables (tops thick.18 mm)

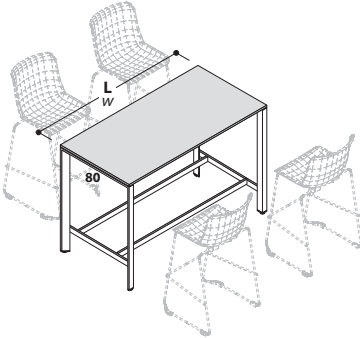
DESCRIZIONE description	L w	CODICE code	KG	M <sup>3</sup>	COLLI	PREZZO price	(*) CODICE FINITURA (*) finish code																																																																																																																																																	
TAVOLI TEAM team tables    L. x p.80 x H.105						<b>GAMBE VERNICIATE</b> ★ painted legs																																																																																																																																																		
							<b>★ GAMBE VERNICIATE / painted legs</b>																																																																																																																																																	
							<table border="1"> <thead> <tr> <th>(*)</th> <th>PIANO</th> <th>STRUTTURA</th> <th>top</th> <th>structure</th> </tr> </thead> <tbody> <tr><td>003</td><td>ROVERE</td><td>ARGENTO</td><td>oak</td><td>silver</td></tr> <tr><td>004</td><td>ROVERE GREY</td><td>ARGENTO</td><td>grey oak</td><td>silver</td></tr> <tr><td>020</td><td>ACERO TAKI</td><td>ARGENTO</td><td>taki maple</td><td>silver</td></tr> <tr><td>040</td><td>BIANCO BR.</td><td>ARGENTO</td><td>br. white</td><td>silver</td></tr> <tr><td>044</td><td>STONE GREY</td><td>ARGENTO</td><td>stone grey</td><td>silver</td></tr> <tr><td>066</td><td>NOCE PAVIA</td><td>ARGENTO</td><td>pavia walnut</td><td>silver</td></tr> <tr><td>090</td><td>WENGE'</td><td>ARGENTO</td><td>wengè</td><td>silver</td></tr> <tr><td>400</td><td>BIANCO BR.</td><td>BIANCO</td><td>br. white</td><td>white</td></tr> <tr><td>403</td><td>ROVERE</td><td>BIANCO</td><td>oak</td><td>white</td></tr> <tr><td>404</td><td>ROVERE GREY</td><td>BIANCO</td><td>grey oak</td><td>white</td></tr> <tr><td>420</td><td>ACERO TAKI</td><td>BIANCO</td><td>taki maple</td><td>white</td></tr> <tr><td>444</td><td>STONE GREY</td><td>BIANCO</td><td>stone grey</td><td>white</td></tr> <tr><td>466</td><td>NOCE PAVIA</td><td>BIANCO</td><td>pavia walnut</td><td>white</td></tr> <tr><td>490</td><td>WENGE'</td><td>BIANCO</td><td>wengè</td><td>white</td></tr> <tr><td>503</td><td>ROVERE</td><td>ANTRACITE</td><td>oak</td><td>anthracite</td></tr> <tr><td>504</td><td>ROVERE GREY</td><td>ANTRACITE</td><td>grey oak</td><td>anthracite</td></tr> <tr><td>521</td><td>ACERO TAKI</td><td>ANTRACITE</td><td>taki maple</td><td>anthracite</td></tr> <tr><td>541</td><td>BIANCO BR.</td><td>ANTRACITE</td><td>br. white</td><td>anthracite</td></tr> <tr><td>544</td><td>STONE GREY</td><td>ANTRACITE</td><td>stone grey</td><td>anthracite</td></tr> <tr><td>566</td><td>NOCE PAVIA</td><td>ANTRACITE</td><td>pavia walnut</td><td>anthracite</td></tr> <tr><td>591</td><td>WENGE'</td><td>ANTRACITE</td><td>wengè</td><td>anthracite</td></tr> <tr><td>803</td><td>ROVERE</td><td>STONE GREY</td><td>oak</td><td>stone grey</td></tr> <tr><td>804</td><td>ROVERE GREY</td><td>STONE GREY</td><td>grey oak</td><td>stone grey</td></tr> <tr><td>820</td><td>ACERO TAKI</td><td>STONE GREY</td><td>taki maple</td><td>stone grey</td></tr> <tr><td>840</td><td>BIANCO BR.</td><td>STONE GREY</td><td>br. white</td><td>stone grey</td></tr> <tr><td>844</td><td>STONE GREY</td><td>STONE GREY</td><td>stone grey</td><td>stone grey</td></tr> <tr><td>866</td><td>NOCE PAVIA</td><td>STONE GREY</td><td>pavia walnut</td><td>stone grey</td></tr> <tr><td>890</td><td>WENGE'</td><td>STONE GREY</td><td>wengè</td><td>stone grey</td></tr> </tbody> </table>	(*)	PIANO	STRUTTURA	top	structure	003	ROVERE	ARGENTO	oak	silver	004	ROVERE GREY	ARGENTO	grey oak	silver	020	ACERO TAKI	ARGENTO	taki maple	silver	040	BIANCO BR.	ARGENTO	br. white	silver	044	STONE GREY	ARGENTO	stone grey	silver	066	NOCE PAVIA	ARGENTO	pavia walnut	silver	090	WENGE'	ARGENTO	wengè	silver	400	BIANCO BR.	BIANCO	br. white	white	403	ROVERE	BIANCO	oak	white	404	ROVERE GREY	BIANCO	grey oak	white	420	ACERO TAKI	BIANCO	taki maple	white	444	STONE GREY	BIANCO	stone grey	white	466	NOCE PAVIA	BIANCO	pavia walnut	white	490	WENGE'	BIANCO	wengè	white	503	ROVERE	ANTRACITE	oak	anthracite	504	ROVERE GREY	ANTRACITE	grey oak	anthracite	521	ACERO TAKI	ANTRACITE	taki maple	anthracite	541	BIANCO BR.	ANTRACITE	br. white	anthracite	544	STONE GREY	ANTRACITE	stone grey	anthracite	566	NOCE PAVIA	ANTRACITE	pavia walnut	anthracite	591	WENGE'	ANTRACITE	wengè	anthracite	803	ROVERE	STONE GREY	oak	stone grey	804	ROVERE GREY	STONE GREY	grey oak	stone grey	820	ACERO TAKI	STONE GREY	taki maple	stone grey	840	BIANCO BR.	STONE GREY	br. white	stone grey	844	STONE GREY	STONE GREY	stone grey	stone grey	866	NOCE PAVIA	STONE GREY	pavia walnut	stone grey	890	WENGE'	STONE GREY	wengè	stone grey
(*)	PIANO	STRUTTURA	top	structure																																																																																																																																																				
003	ROVERE	ARGENTO	oak	silver																																																																																																																																																				
004	ROVERE GREY	ARGENTO	grey oak	silver																																																																																																																																																				
020	ACERO TAKI	ARGENTO	taki maple	silver																																																																																																																																																				
040	BIANCO BR.	ARGENTO	br. white	silver																																																																																																																																																				
044	STONE GREY	ARGENTO	stone grey	silver																																																																																																																																																				
066	NOCE PAVIA	ARGENTO	pavia walnut	silver																																																																																																																																																				
090	WENGE'	ARGENTO	wengè	silver																																																																																																																																																				
400	BIANCO BR.	BIANCO	br. white	white																																																																																																																																																				
403	ROVERE	BIANCO	oak	white																																																																																																																																																				
404	ROVERE GREY	BIANCO	grey oak	white																																																																																																																																																				
420	ACERO TAKI	BIANCO	taki maple	white																																																																																																																																																				
444	STONE GREY	BIANCO	stone grey	white																																																																																																																																																				
466	NOCE PAVIA	BIANCO	pavia walnut	white																																																																																																																																																				
490	WENGE'	BIANCO	wengè	white																																																																																																																																																				
503	ROVERE	ANTRACITE	oak	anthracite																																																																																																																																																				
504	ROVERE GREY	ANTRACITE	grey oak	anthracite																																																																																																																																																				
521	ACERO TAKI	ANTRACITE	taki maple	anthracite																																																																																																																																																				
541	BIANCO BR.	ANTRACITE	br. white	anthracite																																																																																																																																																				
544	STONE GREY	ANTRACITE	stone grey	anthracite																																																																																																																																																				
566	NOCE PAVIA	ANTRACITE	pavia walnut	anthracite																																																																																																																																																				
591	WENGE'	ANTRACITE	wengè	anthracite																																																																																																																																																				
803	ROVERE	STONE GREY	oak	stone grey																																																																																																																																																				
804	ROVERE GREY	STONE GREY	grey oak	stone grey																																																																																																																																																				
820	ACERO TAKI	STONE GREY	taki maple	stone grey																																																																																																																																																				
840	BIANCO BR.	STONE GREY	br. white	stone grey																																																																																																																																																				
844	STONE GREY	STONE GREY	stone grey	stone grey																																																																																																																																																				
866	NOCE PAVIA	STONE GREY	pavia walnut	stone grey																																																																																																																																																				
890	WENGE'	STONE GREY	wengè	stone grey																																																																																																																																																				
	L.160	153 <b>267</b> (*)	46	0,174	4	€ 654,00																																																																																																																																																		
	L.180	153 <b>268</b> (*)	50	0,183	4	€ 685,00																																																																																																																																																		

## DESCRIZIONE TECNICA

### MOD.OXI

#### TAVOLO DA SALOTTO

Costituiti da: piano e basamento legno.

Piano realizzato con pannelli di particelle di legno di spessore mm 25 nobilitato in melaminico. I bordi perimetrali sono in ABS di spessore mm 2 in tinta con la superficie. Il piano è disponibile nei colori: ROVERE 03, NOCE PAVIA 06, GRIGIO 42, STONE GREY 44, BIANCO BR. 69.

Basamento legno realizzato con pannelli di particelle di legno spessore mm 25 per i fianchi, spessore mm 18 per la schiena, nobilitati in melaminico, rifiniti perimetralmente con bordo melaminico spessore mm 0,4 in tinta con la superficie. I fianchi sono dotati di piedini livellatori. Il basamento legno è disponibile nei colori: ARGENTO GOLF 01, NOCE PAVIA 06, STONE GREY 44, BIANCO BR. 69.

#### TAVOLI RIUNIONE CON FIANCHI LEGNO

-I piani di lavoro sono realizzati in pannelli di particelle di legno sp. mm 25 nobilitati in melaminico e bordati perimetralmente in ABS mm 2 in tinta con la superficie e disponibili nei colori: ROVERE 03, NOCE PAVIA 06, GRIGIO 42, STONE GREY 44, BIANCO BR. 69.

-I fianchi sono realizzati in pannelli di particelle di legno sp. mm 25 nobilitati in melaminico e bordati perimetralmente in ABS mm 2 in tinta con la superficie e disponibili nei colori: ARGENTO GOLF 01, NOCE PAVIA 06, STONE GREY 44, BIANCO BR. 69.

-Le schiene sono realizzate in pannelli di particelle di legno spess. mm 18 nobilitati in melaminico e bordati perimetralmente in melaminico mm 0.4 in tinta con la superficie e disponibili nei colori: ARGENTO GOLF 01, NOCE PAVIA 06, STONE GREY 44, BIANCO BR. 69.

#### TAVOLI RIUNIONE CIRCOLARI CON BASAMENTO A COLONNA

Costituito da: piano e basamento metallico.

-Il piano è realizzato con pannello di particelle di legno sp. mm 25 nobilitati in melaminico e bordati perimetralmente in ABS mm 2 in tinta con la superficie e disponibili nei colori: ROVERE 03, NOCE PAVIA 06, GRIGIO 42, STONE GREY 44, BIANCO BR. 69.

-Basamento metallico composto da: base circolare Ø590mm, tubo verticale e crociera superiore.

Il tubo verticale ha una sezione che parte alla base con un Ø128mm e poi sale a un Ø 89mm. La crociera è realizzata con lamiera metallica sp. mm 4 dotata di asole per il fissaggio sottopiano. Il basamento è verniciato a polveri epossidiche nei colori: ARGENTO, BIANCO, STONE GREY.

#### TAVOLI RIUNIONE CON GAMBE METALLICHE A "T" SAGOMATE E TRAVE FISSA CANALIZZATA

- I piani di lavoro sono realizzati in pannelli di particelle di legno sp. mm 25 nobilitati in melaminico e bordati perimetralmente in ABS mm 2 in tinta con la superficie e disponibili nei colori: ROVERE 03, NOCE PAVIA 06, GRIGIO 42, BIANCO BR. 69.

- Trave di sostegno orizzontale realizzata in lamiera metallica pressopiegata con sezione a "C" 46 x 58 x sp. mm 1,5, verniciata a polveri epossidiche nei colori: ARGENTO e BIANCO. E' dotata di asole per la salita dei cablaggi e fori per il fissaggio alle gambe metalliche e al piano.

La sua forma consente direttamente l'alloggiamento dei cavi senza l'utilizzo di vaschette aggiuntive.

Viene fornita imballata con angolari in cartone e foglia di polietilene termoretraibile.

- Gambe metalliche a "T" realizzate in lamiera stampata e verniciata a polveri epossidiche disponibile nei colori: ARGENTO e BIANCO.

Dotate di viti per il fissaggio ai piani, piedini livellatori e di carter passacavi in pvc estruso alloggiato in apposita sede per la salita dei cablaggi. Vengono fornite imballate con angolari in cartone e foglia di polietilene termoretraibile.

#### TAVOLI RIUNIONE CON GAMBE METALLICHE A "T" QUADRATE E TRAVE FISSA CANALIZZATA

- I piani di lavoro sono realizzati in pannelli di particelle di legno sp. mm 25 nobilitati in melaminico e bordati perimetralmente in ABS mm 2 in tinta con la superficie e disponibili nei colori: ROVERE 03, NOCE PAVIA 06, STONE GREY 44, BIANCO BR. 69.

- Trave di sostegno orizzontale realizzata in lamiera metallica pressopiegata con sezione a "C" 46 x 58 x sp. mm 1,5, verniciata a polveri epossidiche nei colori: ARGENTO, BIANCO e STONE GREY. E' dotata di asole per la salita dei cablaggi e fori per il fissaggio alle gambe metalliche e al piano. La sua forma consente direttamente l'alloggiamento dei cavi senza l'utilizzo di vaschette aggiuntive.

Viene fornita imballata con angolari in cartone e foglia di polietilene termoretraibile.

- Gambe metalliche a "T" realizzate in tubo (60 x 30 x 2 tubo orizzontale/ 90 x 60 x 2 ritto verticale), verniciata a polveri epossidiche disponibile nei colori: ARGENTO, BIANCO e STONE GREY.

Dotate di carter di chiusura a scatto per il vano di salita dei cablaggi e tappi in plastica stampata dello stesso colore della struttura.

Sulla base sono inseriti piedini livellatori in nylon. Viene fornita imballata con cartone triplo e completa di viti per il fissaggio ai piani.

#### TAVOLO RIUNIONE CON GAMBE METALLICHE A "PONTE" A SEZIONE TRAPEZOIDALE:

- Il piano di lavoro è realizzato con pannello di particelle di legno sp. mm 25 nobilitato in melaminico e bordato perimetralmente in ABS mm 2 in tinta con la superficie. E' disponibile nei colori: ROVERE 03, NOCE PAVIA 06, STONE GREY 44, BIANCO BR. 69. Il piano è dotato di Top Access integrato, con cornice in plastica stampata colore argento e coperchio realizzato con pannello di particelle di legno sp. mm8 dello stesso colore dei piani.

- Il basamento metallico a ponte è costituito da: 2 gambe a ponte e 4 travi longitudinali.

- Le travi hanno una lunghezza fissa e sono realizzate con tubo metallico di sezione 50x15x1,5 nei colori ARGENTO, BIANCO e STONE GREY. Le gambe a ponte sono realizzate in tubo di acciaio trafilato a sezione trapezoidale, sp. mm 2 verniciate a polveri epossidiche nei colori: ARGENTO, BIANCO e STONE GREY. La parte orizzontale è costituita da tubo metallico di sezione 50x20x1.5 e rimane arretrata rispetto alla parte a vista della gamba.

## DESCRIZIONE TECNICA

### MOD. LOGIC

#### TAVOLO RIUNIONE CON FIANCHI LEGNO

-Piano realizzato con pannello di particelle di legno sp. mm 25 nobilitato in melaminico, disponibili nei colori: ROVERE 03, NOCE PAVIA 06, BIANCO BR. 69. I bordi perimetrali sono in ABS sp. mm 2 in abbinamento ai fianchi BIANCO BR. 69. L'assemblaggio con le strutture avviene utilizzando viti passo metrico su bussole pre-montate.

Il piano è dotato di travi metalliche portanti, con supporti stampati con cava a coda di rondine con viti passo metrico su bussole pre-montate ai fianchi legno. Sul piano è inserito un top access integrato, con cornice in profilato di alluminio estruso anodizzato, coperchio con apertura a ribalta e spazzolino parapolvere nero.

-Fianchi realizzati con pannelli di particelle di legno sp. mm 50 nobilitati in melaminico, disponibili nel colore BIANCO BR. 69.

Sono rifiniti perimetralmente con bordo in ABS sp. mm 2 in tinta con la superficie, sono dotati di piedini livellatori e sono predisposti per l'aggancio delle travi portanti.

#### TAVOLO RIUNIONE CON BASAMENTO A COLONNA

-Piano realizzato con pannello di particelle di legno sp. mm 25 nobilitato in melaminico, disponibili nei colori: ROVERE 03, NOCE PAVIA 06, BIANCO BR. 69. I bordi perimetrali sono in ABS sp. mm 2 colore bianco. L'assemblaggio con il basamento avviene utilizzando viti passo metrico su bussole pre-montate.

-Basamento metallico composto da: base circolare Ø590mm, tubo verticale e crociera superiore.

Il tubo verticale ha una sezione che parte alla base con un Ø128mm e poi sale a un Ø 89mm. La crociera è realizzata con lamiera metallica sp. mm 4 dotata di asole per il fissaggio sottopiano. Il basamento è verniciato a polveri epossidiche BIANCO BR. (BI 01).

---

### MOD.5TH ELEMENT

#### TAVOLI RIUNIONE CON GAMBE A PONTE

I piani di lavoro sono realizzati con pannelli di particelle di legno sp. mm 18 nobilitati in melaminico (Classe E1 basso contenuto di Formaldeide) e bordati perimetralmente in ABS mm 2 in tinta con la superficie e disponibili nei colori: ROVERE 03, ROVERE GREY 04, NOCE PAVIA 06, STONE GREY 44, WENGE' 45, ACERO TAKI 58, BIANCO BR. 69. I piani sono dotati di Top Access integrato, con cornice in plastica stampata colore argento e coperchio realizzato con pannello di particelle di legno sp. mm8 dello stesso colore dei piani.

Le gambe a ponte "TERMINALI" sono realizzate in tubolare di acciaio trafilato a sezione trapezoidale, sp. mm 2 verniciate a polveri epossidiche nei colori: ARGENTO, BIANCO, ANTRACITE, STONE GREY. Sono dotate alle due estremità inferiori di puntali in Nylon stampato con alloggiato il piedino livellatore.

Nella parte trasversale superiore sono predisposte per il fissaggio delle travi portanti.

Le gambe a ponte "CENTRALI" sono realizzate in tubolare di acciaio trafilato a sezione quadrata 50x50 x sp. 2 mm verniciate a polveri epossidiche nei colori: ARGENTO, BIANCO, ANTRACITE, STONE GREY. Sono dotate alle due estremità inferiori di puntali in Nylon stampato con alloggiato il piedino livellatore.

Nella parte trasversale superiore di sezione rettangolare 100 x 50 x sp 2 mm sono predisposte per il fissaggio delle travi portanti.

Sono disponibili in due tipologie: aperta o chiusa tramite pannellatura in lamiera di acciaio sp mm 1 con 1 lato fisso ed un lato ispezionabile uso "WIRE MANAGER" per il contenimento di cablaggi e relative apparecchiature ed eccedenze.

Le travi portanti sono realizzate in tubolare di acciaio trafilato a sezione rettangolare 50 x 15 x sp 1,5 mm, verniciate a polveri epossidiche nel colore ARGENTO.

Alle estremità sono dotate di piastre in acciaio stampato per il collegamento al traverso superiore delle gambe e per il fissaggio dei piani di lavoro. Sono fornite complete di carter in ABS stampato atti a mascherare le viti di accoppiamento gamba/trave.

## TECHNICAL DESCRIPTIONS

### MOD.OXI

#### COFFEE TABLE

Composed of: top and wooden base.

- Top made of particleboard panels 40mm thick that are melamine faced. The edge trim is 2mm ABS matching the surface. The top is available in colours: OAK 03, PAVIA WALNUT 06, GREY 42, STONE GREY 44, BR. WHITE 69

- Wooden base made of 25 mm thick melamine faced particleboard panels for sides, 18 mm thick for back panel, finished with 0,4 mm melamine edging strip of the same shade as the surface. The side panels are equipped with adjustable feet.

The wooden base is available in colours: GOLF SILVER 01, PAVIA WALNUT 06, STONE GREY 44, BR. WHITE 69.

#### MEETING TABLES WITH PANELS BASE

- The work tops are in particleboards, thickness 25 mm, with melamine facing and edge-finishing in 2 mm ABS matching the main shade, available in the following colours: OAK 03, PAVIA WALNUT 06, GREY 42, STONE GREY 44, BR. WHITE 69.

- The sides are in particleboards, thickness 25 mm, with melamine facing and edge-finishing in 2 mm ABS matching the main shade, available in the following colours: GOLF SILVER 01, PAVIA WALNUT 06, STONE GREY 44, BR. WHITE 69.

- The backs are in particleboards, thickness 18 mm, with melamine facing and edge-finishing in 0.4 mm ABS matching the main shade, available in the following colours: GOLF SILVER 01, PAVIA WALNUT 06, STONE GREY 44, BR. WHITE 69.

The sides are complete with abs liners that allow insertion of adjustable feet.

#### CIRCULAR MEETING TABLE WITH COLUMN BASE

Composed of: top and column base.

- The top is in particleboards, thickness 25 mm, with melamine facing and edge-finishing in 2 mm ABS matching the main shade, available in the following colours: OAK 03, PAVIA WALNUT 06, GREY 42, STONE GREY 44, BR. WHITE 69.

- Metal base composed of: circular base Ø590mm, vertical column and upper plate.

The column is made with a tube that has a section that starts at the base with a Ø128mm and then rises to a Ø89mm. The top plate is made of sheet metal 4 mm thick with holes for fixing under the top. The metal base is painted with epoxy powder in colours: SILVER, WHITE, STONE GREY.

#### MEETING TABLES WITH "T" SHAPED METAL LEGS AND FIXED CABLE-WAY BEAM

- The work tops are in particleboards, thickness 25 mm, with melamine facing and edge-finishing in 2 mm ABS matching the main shade, available in the following colours: OAK 03, PAVIA WALNUT 06, GREY 42, BR. WHITE 69.

- "C" shaped support beam made from die-cast sheet metal with a section of dimensions 46 x 58 x thick.1,5 mm. It is painted with epoxy powder in colours : SILVER and WHITE. The beam has holes for the ascent of the wiring and for attachment to metal legs and tops.

Its shape allows directly the cable housing without the use of additional trays. Supplied packaged with cardboard corners and thermo-retractable polyethylene sheet.

- "T" shaped legs made from pressed steel and painted with epoxy powder in the following colours: SILVER and WHITE.

It is supplied with fixing screws for the tops, levelling feet and carter cable management made from extruded PVC and fitted into a specific casing for ascent of the cables. Available in 2 versions: for 60cm and 80cm work top depths; can also be used in a central position between two contiguous tops. Supplied packaged with cardboard corners and thermo-retractable polyethylene sheet.

#### MEETING TABLES WITH "T" SQUARED METAL LEGS AND FIXED CABLE-WAY BEAM

- The work tops are in particleboards, thickness 25 mm, with melamine facing and edge-finishing in 2 mm ABS matching the main shade, available in the following colours: OAK 03, PAVIA WALNUT 06, STONE GREY 44, BR. WHITE 69.

- "C" shaped support beam made from die-cast sheet metal with a section of dimensions 46 x 58 x thick.1,5 mm. It is painted with epoxy powder in colours : SILVER, WHITE and STONE GREY. The beam has holes for the ascent of the wiring and for attachment to metal legs and tops.

Its shape allows directly the cable housing without the use of additional trays. Supplied packaged with cardboard corners and thermo-retractable polyethylene sheet.

- "T" shaped legs made from tubular steel (60 x 30 x 2/ 90 x 60 x 2) and painted with epoxy powder in the following colours: SILVER, WHITE and STONE GREY.

It is supplied with fixing screws for the tops, levelling feet and carter cable management made from extruded PVC and fitted into a specific casing for ascent of the cables. Available in 2 versions: for 60cm and 80cm work top depths; can also be used in a central position between two contiguous tops.

Supplied packaged with cardboard corners and thermo-retractable polyethylene sheet.

#### MEETING TABLES WITH "BRIDGE" METAL LEGS WITH TRAPEZOID SECTION

- The work top is in particleboards panel, thickness 25 mm, with melamine facing and edge-finishing in 2 mm ABS matching the main shade, available in the following colours: OAK 03, PAVIA WALNUT 06, GREY 42, BR. WHITE 69.

The work top is equipped with integrated Top Access, made of silver printed plastic frame and 8mm thick cover made of melamine faced particleboard panel in the same colour as the worktop surface.

The bridge leg steel base is made from: 2 bridge legs and 4 longitudinal beams.

- The beams have a unique length for all the desks. The beams are made with metal tubular with section 50x15x1,5mm in the following colours: SILVER, WHITE, STONE GREY.

- The bridge legs are made from trapezoid tubular steel, 2 mm thick painted with epoxy powder in the following colours: SILVER, WHITE, STONE GREY. In the horizontal part there are holes, for fixing of the desk tops and the beams.

## TECHNICAL DESCRIPTIONS

### MOD. LOGIC

#### MEETING TABLE WITH WOODEN BASE

-Top made with 25 mm particleboard panel, melamine-faced, available in: OAK 03, PAVIA WALNUT 06, BR. WHITE 69. The perimeter shaped borders are in 2 mm ABS BR. white colour matching the side panels.

The structure assembly takes places using metric step screws on pre-mounted compasses.

The top is equipped with metallic support beams, with dovetail pit printed supports with metric step screws on pre-mounted compasses at the wooden sides. On the table is inserted a Top Access made of anodised extruded aluminium, equipped with flap opening door and black dust seal brush.

-Wooden side panels made with 50 mm particleboard panels, melamine-faced, available in BR. WHITE 69 colour.

They are perimeter refined with 2 mm ABS edge colour matching the surface. All sides are equipped with levelling feet and are pre-arranged for hooking supporting beams.

#### CIRCULAR MEETING TABLE WITH COLUMN BASE

Composed of: top and column base.

-Top made with 25 mm particleboard panel, melamine-faced, available in: OAK 03, PAVIA WALNUT 06, BR. WHITE 69. The perimeter shaped borders are in 2 mm ABS white colour matching the base.

The structure assembly takes places using metric step screws on pre-mounted compasses.

- Metal base composed of: circular base Ø590mm, vertical column and upper plate.

The column is made with a tube that has a section that starts at the base with a Ø128mm and then rises to a Ø 89mm. The top plate is made of sheet metal sp. 4 mm with holes for fixing undertop. The metal base is painted with epoxy powder in the colour BR. WHITE (BI 01).

---

### MOD.5TH ELEMENT

#### MEETING TABLES WITH BRIDGE LEGS:

The workstation tops are made with 18mm-thick melamine faced particleboard (Class E1 low formaldehyde content) and perimetrically bordered with 2mm ABS that matches the top surface; available in the following colours: OAK 03, GREY OAK 04, PAVIA WALNUT 06, STONE GREY 44, WENGE' 45, TAKI MAPLE 58, BIANCO BR. 69. The workstation tops are equipped with integrated Top Access made of printed plastic that is the same colour as the top.

The TERMINAL bridge legs are made of 2mm trapezoidal-sectioned drawn tubular steel, painted with epoxy powders in the following colours: SILVER, WHITE, ANTHRACITE. At the two lower ends they are equipped with printed Nylon feet that house the levelling feet.

They are pre-fitted on the upper transversal part for the attachment of the supporting beams.

The "CENTRAL or SHARED" bridge legs are made of square-sectioned drawn tubular steel, 50 x50 x 2 mm-thick, painted with epoxy powders in the following colours: SILVER, WHITE, ANTHRACITE. At the two lower ends they are equipped with printed Nylon feet that house a levelling foot.

At the rectangular sectioned upper transversal part, 100 x 50 x 2 mm thick, they are pre-fitted for the attachment of the supporting beams.

Two types are available: open or closed via a 1 mm-thick sheet steel panelling with 1 fixed side and one inspectionable "WIRE MANAGER" side used to house wiring, related equipment and surplus materials.

The supporting beams are made of rectangular-sectioned drawn tubular steel 50 x 15 x 1,5 mm thick, painted with epoxy powders in SILVER.

At the ends, they are equipped with printed steel plates for the connection to the upper transversal rod of the legs and for mounting the workstation tops.

They are supplied complete with ABS carters that serve to conceal the leg/beam coupling screws.

Hanging accessories, including PC tower stands and wire conduits made of press-folded sheet steel can be fastened to the complete metal structure.

**INDICE DEI CODICI**  
codes index

\* = INDICARE IL CODICE FINITURA  
= complete with finish code

INDICE DEI CODICI codes index  
LOUNGE AND MEETING TABLES (OPERATIVE SELECTION)

MODELLO model	CODICE code	DESCRIZIONE description	SP.PIANO top thick.	NOTE notes	NOTE notes	PAG. page	PREZZO price
OXI	<b>148563</b>	* TAVOLO DA SALOTTO L.60 coffee table w 60 cms	25 mm			3	€ 130,00
OXI	<b>148566</b>	* TAVOLO RIUNIONE RETTANGOLARE L.210 x p.100 CON BASAMENTO LEGNO rectangular meeting table w 210 x d 100 cms with panels base	25 mm			3	€ 204,00
OXI	<b>148567</b>	* TAVOLO RIUNIONE RETTANGOLARE L.260 x p.100 CON BASAMENTO LEGNO rectangular meeting table w 260 x d 100 cms with panels base	25 mm			3	€ 245,00
OXI	<b>148568</b>	* TAVOLO RIUNIONE CIRCOLARE Ø 80 CM CON BASAMENTO METALLICO round meeting table Ø 80 cms with metal base	25 mm			4	€ 356,00
OXI	<b>148569</b>	* TAVOLO RIUNIONE CIRCOLARE Ø 100 CM CON BASAMENTO METALLICO round meeting table Ø 100 cms with metal base	25 mm			4	€ 381,00
OXI	<b>148570</b>	* TAVOLO RIUNIONE CIRCOLARE Ø 120 CM CON BASAMENTO METALLICO round meeting table Ø 120 cms with metal base	25 mm			4	€ 403,00
OXI	<b>148571</b>	* TAVOLO RIUNIONE RETTANGOLARE L.210 x p.100 CON GAMBE A "T" SAGOMATE rectangular meeting table w 210 x d 100 cms with "T" shaped metal legs	25 mm			4	€ 246,00
OXI	<b>148572</b>	* TAVOLO RIUNIONE RETTANGOLARE L.260 x p.100 CON GAMBE A "T" SAGOMATE rectangular meeting table w 260 x d 100 cms with "T" shaped metal legs	25 mm			4	€ 289,00
OXI	<b>148573</b>	* TAVOLO RIUNIONE RETTANGOLARE L.210 x p.100 CON GAMBE A "T" SQUADRATE rectangular meeting table w 210 x d 100 cms with "T" squared metal legs	25 mm			4	€ 270,00
OXI	<b>148574</b>	* TAVOLO RIUNIONE RETTANGOLARE L.260 x p.100 CON GAMBE A "T" SQUADRATE rectangular meeting table w 260 x d 100 cms with "T" squared metal legs	25 mm			4	€ 313,00
OXI	<b>148575</b>	* TAVOLO RIUNIONE QUADRATO L.120 x p.125,2 CON GAMBE A "PONTE" TRAPEZOIDALI squared meeting table w 120 x d 125,2 cms with "bridge" trapezoidal legs				4	€ 426,00
OXI	<b>148576</b>	* VASCHETTA CENTRALE PASSACAVI PER TAVOLO RIUNIONE ART.575 central cable tray for meeting table art.575				4	€ 54,00
5TH ELEMENT	<b>153136</b>	* TAVOLO RIUNIONE L.240 x p.125,2 meeting table w 240 x d 125,2 cms	18 mm	CON GAMBA CENTRALE APERTA with open central leg	GAMBE VERNICIATE painted legs	7	€ 850,00
5TH ELEMENT	<b>153137</b>	* TAVOLO RIUNIONE L.360 x p.125,2 meeting table w 360 x d 125,2 cms	18 mm	CON GAMBE CENTRALI APERTE with open central legs	GAMBE VERNICIATE painted legs	7	€ 1.200,00
5TH ELEMENT	<b>153180</b>	* TAVOLO RIUNIONE L.120 x p.125,2 meeting table w 120 x d 125,2 cms	18 mm		GAMBE VERNICIATE painted legs	6	€ 500,00
5TH ELEMENT	<b>153180</b>	* TAVOLO RIUNIONE L.120 x p.125,2 meeting table w 120 x d 125,2 cms	18 mm		GAMBE CROMATE chromed legs	6	€ 954,00
5TH ELEMENT	<b>153181</b>	* TAVOLO RIUNIONE L.320 x p.125,2 meeting table w 320 x d 125,2 cms	18 mm	CON GAMBA CENTRALE APERTA with open central leg	GAMBE VERNICIATE painted legs	7	€ 950,00
5TH ELEMENT	<b>153182</b>	* TAVOLO RIUNIONE L.480 x p.125,2 meeting table w 480 x d 125,2 cms	18 mm	CON GAMBE CENTRALI APERTE with open central legs	GAMBE VERNICIATE painted legs	7	€ 1.350,00
5TH ELEMENT	<b>153185</b>	* TAVOLO RIUNIONE L.120 x p.125,2 meeting table w 120 x d 125,2 cms	18 mm		GAMBE VERNICIATE painted legs	8	€ 625,00
5TH ELEMENT	<b>153186</b>	* TAVOLO RIUNIONE L.320 x p.125,2 meeting table w 320 x d 125,2 cms	18 mm	CON GAMBA CENTRALE APERTA with open central leg	GAMBE VERNICIATE painted legs	8	€ 1.066,00
5TH ELEMENT	<b>153187</b>	* TAVOLO RIUNIONE L.480 x p.125,2 meeting table w 480 x d 125,2 cms	18 mm	CON GAMBE CENTRALI APERTE with open central legs	GAMBE VERNICIATE painted legs	8	€ 1.507,00
5TH ELEMENT	<b>153194</b>	* TAVOLO RIUNIONE L.160 x p.125,2 meeting table w 160 x d 125,2 cms	18 mm		GAMBE VERNICIATE painted legs	6	€ 550,00
5TH ELEMENT	<b>153194</b>	* TAVOLO RIUNIONE L.160 x p.125,2 meeting table w 160 x d 125,2 cms	18 mm		GAMBE CROMATE chromed legs	6	€ 1.004,00
5TH ELEMENT	<b>153241</b>	* VASCHETTA CENTRALE PASSACAVI L.90 PER TAVOLI RIUNIONE central cable tray w 90 cms for meeting tables				9	€ 54,00
5TH ELEMENT	<b>153243</b>	* VASCHETTA CENTRALE PASSACAVI L.121 PER TAVOLI RIUNIONE central cable tray w 121 cms for meeting tables				9	€ 61,00
5TH ELEMENT	<b>153267</b>	* TAVOLO TEAM L.160 X P.80 X H.105 team table w 160 x d 80 x h 105	18 mm		GAMBE VERNICIATE painted legs	10	€ 654,00
5TH ELEMENT	<b>153268</b>	* TAVOLO TEAM L.180 X P.80 X H.105 team table w 180 x d 80 x h 105	18 mm		GAMBE VERNICIATE painted legs	10	€ 685,00
5TH ELEMENT	<b>153536</b>	* PIANO TAVOLO RIUNIONE L.120 x p.125,2 meeting tabletop w 120 x d 125,2 cms	18 mm	SENZA TOP ACCESS without top access		9	€ 83,00
5TH ELEMENT	<b>153539</b>	* PIANO TAVOLO RIUNIONE L.160 x p.125,2 meeting tabletop w 160 x d 125,2 cms	18 mm	SENZA TOP ACCESS without top access		9	€ 107,00
5TH ELEMENT	<b>153543</b>	* PIANO TAVOLO RIUNIONE L.160 x p.165,2 meeting tabletop w 160 x d 165,2 cms	18 mm	SENZA TOP ACCESS without top access		9	€ 137,00
5TH ELEMENT	<b>153702</b>	* GAMBA A PONTE TERMINALE PROF. CM 125 terminal bridge leg deep 125 cms				8	€ 128,00
5TH ELEMENT	<b>153703</b>	* GAMBA A PONTE TERMINALE PROF. CM 165 terminal bridge leg deep 165 cms				8	€ 152,00
5TH ELEMENT	<b>153708</b>	* GAMBA A PONTE CENTRALE PROF. CM 125 central bridge leg deep 125 cms				8	€ 106,00
5TH ELEMENT	<b>153709</b>	* GAMBA A PONTE CENTRALE PROF. CM 165 central bridge leg deep 165 cms				8	€ 120,00
5TH ELEMENT	<b>153721</b>	* COPPIA DI TRAVI L.120 PER GAMBE A PONTE set of 2 beams w 120 for bridge legs				8	€ 68,00
5TH ELEMENT	<b>153723</b>	* COPPIA DI TRAVI L.160 PER GAMBE A PONTE set of 2 beams w 160 for bridge legs				8	€ 81,00
5TH ELEMENT	<b>153738</b>	* KIT WIRE-MANAGER PROF. CM 125,2 wire manager kit deep 125,2 cms				8	€ 117,00
5TH ELEMENT	<b>153739</b>	* KIT WIRE-MANAGER PROF. CM 165,2 wire manager kit deep 165,2 cms				8	€ 119,00
5TH ELEMENT	<b>153825</b>	* PIANO TAVOLO RIUNIONE L.160 x p.125,2 meeting tabletop w 160 x d 125,2 cms	18 mm	CON TOP ACCESS with top access		9	€ 132,00
5TH ELEMENT	<b>153826</b>	* PIANO TAVOLO RIUNIONE L.120 x p.125,2 meeting tabletop w 120 x d 125,2 cms	18 mm	CON TOP ACCESS with top access		9	€ 108,00

\* = INDICARE IL CODICE FINITURA  
 = complete with finish code

INDICE DEI CODICI *codes index*  
 LOUNGE AND MEETING TABLES (OPERATIVE SELECTION)

MODELLO model	CODICE code	DESCRIZIONE description	SP.PIANO top thick.	NOTE notes	NOTE notes	PAG. page	PREZZO price
5TH ELEMENT	<b>153827</b>	* PIANO TAVOLO RIUNIONE L.160 x p.165,2 meeting tabletop w 160 x d 165,2 cms	18 mm	CON TOP ACCESS with top access		9	€ 159,00
LOGIC	<b>154473</b>	* TAVOLO RIUNIONE CIRCOLARE Ø 120 CON BASAMENTO METALLICO round meeting table Ø 120 cms with metal base	25 mm			5	€ 414,00
LOGIC	<b>154598</b>	* TAVOLO RIUNIONE RETTANGOLARE L.180 rectangular meeting table w 180 cms	25 mm	CON TOP ACCESS with top access		5	€ 531,00
LOGIC	<b>154599</b>	* TAVOLO RIUNIONE RETTANGOLARE L.240 rectangular meeting table w 240 cms	25 mm	CON TOP ACCESS with top access		5	€ 600,00





LISTINO 2018  
PRICE LIST

# OYO

TAVOLI RIBALTABILI e PIEGHEVOLI  
Tilting and folding tables



Certificato 04/16

IMPORTANTE / it's very important

SULL'ORDINE INDICARE SEMPRE IL CODICE COMPLETO A 9 CIFRE  
always indicate on the order the complete 9-digit code

ESEMPIO: PER ORDINARE 1 TAVOLO ART.611 WENGE' INDICARE IL CODICE =  
example: to order 1 TABLE ART.611 WENGE indicate the code =

	<b>175</b>	<b>611</b>	<b>030</b>
	MODELLO	ARTICOLO	CODICE FINITURA (*)
	model	articolo	finish code (**)
DECODIFICA decoding	→		

OYO TAVOLI  
OYO tables

In vigore dal:  
Valid from:  
01/01/2018

Valido fino a nuova emissione  
Valid until new emission

**CARTELLA COLORI**  
*colours samples card*



**COD. 03**  
ROVERE | OAK

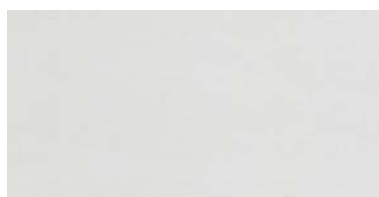

**COD. 42**  
GRIGIO | GREY



**COD. 58**  
ACERO TAKI | TAKI MAPLE



**COD. 04**  
ROVERE GREY | GREY OAK



**COD. 44**  
STONE GREY | STONE GREY

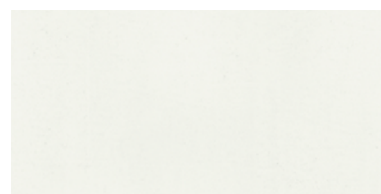

**COD. 69**  
BIANCO BR. | BR. WHITE



**COD. 06**  
NOCE PAVIA | PAVIA WALNUT



**COD. 45**  
WENGÉ | WENGÉ



**N.B.: CASSETTIERE SU RUOTE, MOBILI CONTENITORI  
E LIBRERIE A SPALLA UNICA  
SONO INSERITI NEL CAPITOLO "CONTENITORI UNIVERSALI EVO"**  
*PLEASE NOTE: you can find pedestal on wheels, cabinet models  
and bookcases with shared side panel in the section "UNIVERSAL CABINETS EVO"*

## MODALITÀ DI UTILIZZO layout solutions

### - TIPO 1 -

TAVOLO CON PIANO RIBALTABILE (DOTATO DI RUOTE CON FRENO)

#### - TYPE 1 -

table with tilting top (wheels with brake)



### - TIPO 2 -

TAVOLO CON GAMBE PIEGHEVOLI

#### - TYPE 2 -

table with folding legs

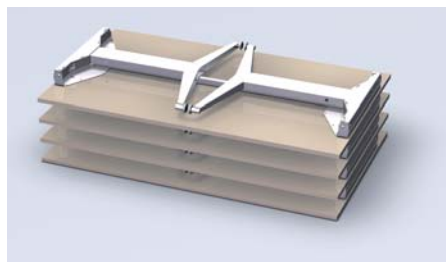

## Modalità di utilizzo / Layout solutions

A	TIPO/type 1	TIPO/type 2
Prof. dei Tavoli depth desktop 60	✓	✓
70	✓	✓
80	✓	✓

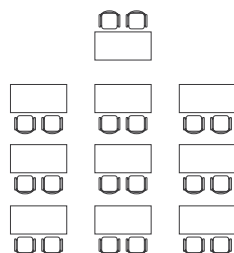

B	TIPO/type 1	TIPO/type 2
Prof. dei Tavoli depth desktop 60	-----	-----
70	✓	-----
80	✓	✓

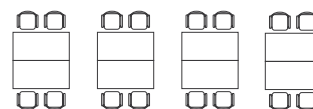

C	TIPO/type 1	TIPO/type 2
Prof. dei Tavoli depth desktop 60	✓	-----
70	✓	-----
80	✓	✓

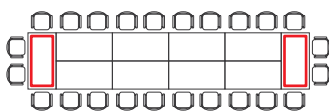

	TIPO/type 1	TIPO/type 2
Prof. dei Tavoli depth desktop 60	✓	✓
70	✓	✓
80	-----	-----

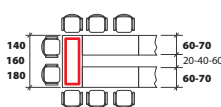

D	TIPO/type 1	TIPO/type 2
Prof. dei Tavoli depth desktop 60	✓	✓
70	✓	-----
80	✓	✓

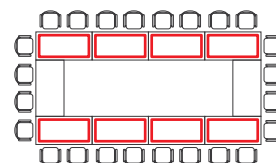

E	TIPO/type 1	TIPO/type 2
Prof. dei Tavoli depth desktop 60	✓	✓
70	✓	✓
80	✓	✓

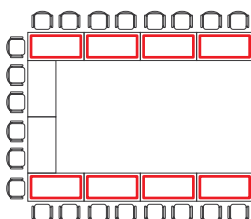

F	TIPO/type 1	TIPO/type 2
Prof. dei Tavoli depth desktop 60	✓	✓
70	✓	✓
80	✓	✓

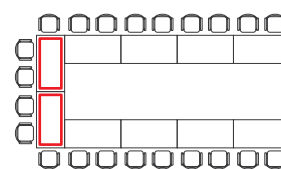

Utilizzare tavoli Tipo 1 con **prof. cm60 SOLO** nelle posizioni contrassegnate con **→**

Use tables Type 1 with **depth 60 cms** in the positions indicated **ONLY** with symbol **→**



PIANI sp. 25mm  
tops thick. 25mm

## TIPO 1 - TAVOLI CON PIANO RIBALTABILE

### type 1 - tables with tilting top

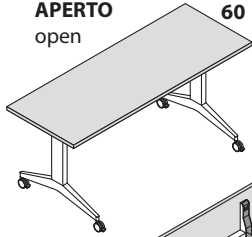
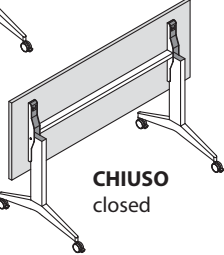
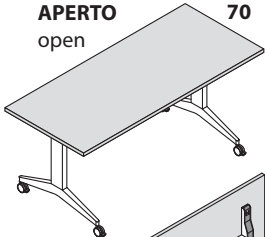
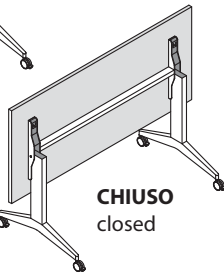
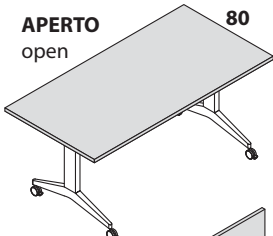
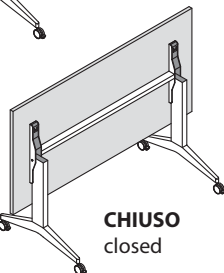
DESCRIZIONE description	L w	CODICE code	KG	M <sup>3</sup>	COLLI	PREZZO price	(*) CODICE FINITURA (*) finish code
TAVOLO CON PIANO RIBALTABILE PROF. CM 60 (DOTATO DI RUOTE CON FRENO) table with tilting top deep 60 cms (wheels with brake)   <b>APERTO</b> open   <b>CHIUSO</b> closed  L. x p. <b>60</b> x H.73,5	L.140	<b>175 611 (*)</b>	34,5	0,145	<b>3</b>	<b>€ 406,00</b>	
	L.160	<b>175 612 (*)</b>	37,5	0,151	<b>3</b>	<b>€ 412,00</b>	
	L.180	<b>175 613 (*)</b>	40,5	0,168	<b>3</b>	<b>€ 428,00</b>	
TAVOLO CON PIANO RIBALTABILE PROF. CM 70 (DOTATO DI RUOTE CON FRENO) table with tilting top deep 70 cms (wheels with brake)   <b>APERTO</b> open   <b>CHIUSO</b> closed  L. x p. <b>70</b> x H.73,5	L.140	<b>175 661 (*)</b>	35,5	0,152	<b>3</b>	<b>€ 415,00</b>	(*) PIANO BASE top base
	L.160	<b>175 662 (*)</b>	38,5	0,157	<b>3</b>	<b>€ 423,00</b>	<b>003</b> ROVERE ARGENTO oak silver
	L.180	<b>175 663 (*)</b>	41,5	0,177	<b>3</b>	<b>€ 439,00</b>	<b>004</b> ROVERE GREY ARGENTO grey oak silver
							<b>015</b> ACERO TAKI ARGENTO taki maple silver
TAVOLO CON PIANO RIBALTABILE PROF. CM 80 (DOTATO DI RUOTE CON FRENO) table with tilting top deep 80 cms (wheels with brake)   <b>APERTO</b> open   <b>CHIUSO</b> closed  L. x p. <b>80</b> x H.73,5	L.140	<b>175 616 (*)</b>	36,5	0,164	<b>3</b>	<b>€ 415,00</b>	<b>025</b> GRIGIO ARGENTO grey silver
	L.160	<b>175 617 (*)</b>	39,5	0,173	<b>3</b>	<b>€ 423,00</b>	<b>030</b> WENGE' ARGENTO wengè silver
	L.180	<b>175 618 (*)</b>	42,5	0,193	<b>3</b>	<b>€ 439,00</b>	<b>040</b> BIANCO BR. ARGENTO br. white silver
							<b>044</b> STONE GREY ARGENTO stone grey silver
							<b>066</b> NOCE PAVIA ARGENTO pavia walnut silver
							<b>403</b> ROVERE BIANCO oak white
							<b>404</b> ROVERE GREY BIANCO grey oak white
							<b>415</b> ACERO TAKI BIANCO taki maple white
							<b>425</b> GRIGIO BIANCO grey white
							<b>430</b> WENGE' BIANCO wengè white
							<b>440</b> BIANCO BR. BIANCO br. white white
							<b>444</b> STONE GREY BIANCO stone grey white
							<b>466</b> NOCE PAVIA BIANCO pavia walnut white
							<b>603</b> ROVERE ANTRACITE oak anthracite
							<b>604</b> ROVERE GREY ANTRACITE grey oak anthracite
							<b>615</b> ACERO TAKI ANTRACITE taki maple anthracite
							<b>625</b> GRIGIO ANTRACITE grey anthracite
							<b>630</b> WENGE' ANTRACITE wengè anthracite
							<b>640</b> BIANCO BR. ANTRACITE br. white anthracite
							<b>644</b> STONE GREY ANTRACITE stone grey anthracite
							<b>666</b> NOCE PAVIA ANTRACITE pavia walnut anthracite

PIANI sp. 25mm  
tops thick. 25mm

**TIPO 2 - TAVOLO CON GAMBE PIEGHEVOLI**  
*type 2 - table with folding legs*

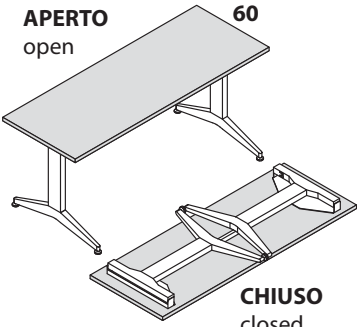
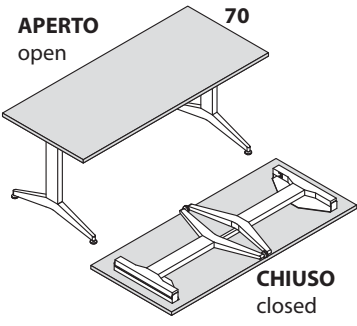
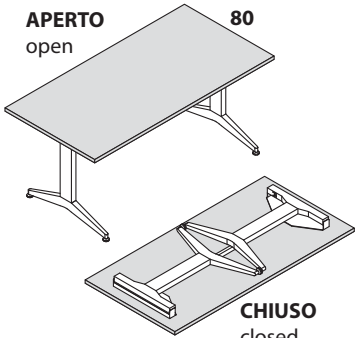
DESCRIZIONE <i>description</i>	L <i>w</i>	CODICE <i>code</i>	KG	M <sup>3</sup>	COLLI	PREZZO <i>price</i>	(*) CODICE FINITURA <i>(*) finish code</i>																																																																																																																													
<p>TAVOLO CON GAMBE PIEGHEVOLI PROF. CM 60 <i>table with folding legs deep 60 cms</i></p>  <p><b>APERTO</b> open</p> <p><b>60</b></p> <p><b>CHIUSO</b> closed</p> <p>L. x p. <b>60</b> x H.73,5</p>	L.140	<b>175 631 (*)</b>	34,5	0,145	<b>3</b>	<b>€ 310,00</b>																																																																																																																														
	L.160	<b>175 632 (*)</b>	37,5	0,151	<b>3</b>	<b>€ 316,00</b>																																																																																																																														
	L.180	<b>175 633 (*)</b>	40,5	0,168	<b>3</b>	<b>€ 323,00</b>																																																																																																																														
<p>TAVOLO CON GAMBE PIEGHEVOLI PROF. CM 70 <i>table with folding legs deep 70 cms</i></p>  <p><b>APERTO</b> open</p> <p><b>70</b></p> <p><b>CHIUSO</b> closed</p> <p>L. x p. <b>70</b> x H.73,5</p>	L.140	<b>175 666 (*)</b>	35,5	0,152	<b>3</b>	<b>€ 319,00</b>																																																																																																																														
	L.160	<b>175 667 (*)</b>	38,5	0,157	<b>3</b>	<b>€ 327,00</b>																																																																																																																														
	L.180	<b>175 668 (*)</b>	41,5	0,177	<b>3</b>	<b>€ 334,00</b>																																																																																																																														
<p>TAVOLO CON GAMBE PIEGHEVOLI PROF. CM.80 <i>table with folding legs deep 80 cms</i></p>  <p><b>APERTO</b> open</p> <p><b>80</b></p> <p><b>CHIUSO</b> closed</p> <p>L. x p. <b>80</b> x H.73,5</p>	L.140	<b>175 636 (*)</b>	36,5	0,164	<b>3</b>	<b>€ 319,00</b>																																																																																																																														
	L.160	<b>175 637 (*)</b>	39,5	0,173	<b>3</b>	<b>€ 327,00</b>																																																																																																																														
	L.180	<b>175 638 (*)</b>	42,5	0,193	<b>3</b>	<b>€ 334,00</b>																																																																																																																														
							<table border="1"> <thead> <tr> <th>(*)</th> <th>PIANO</th> <th>BASE</th> <th>top</th> <th>base</th> </tr> </thead> <tbody> <tr><td>003</td><td>ROVERE</td><td>ARGENTO</td><td>oak</td><td>silver</td></tr> <tr><td>004</td><td>ROVERE GREY</td><td>ARGENTO</td><td>grey oak</td><td>silver</td></tr> <tr><td>015</td><td>ACERO TAKI</td><td>ARGENTO</td><td>taki maple</td><td>silver</td></tr> <tr><td>025</td><td>GRIGIO</td><td>ARGENTO</td><td>grey</td><td>silver</td></tr> <tr><td>030</td><td>WENGE'</td><td>ARGENTO</td><td>wengè</td><td>silver</td></tr> <tr><td>040</td><td>BIANCO BR.</td><td>ARGENTO</td><td>br. white</td><td>silver</td></tr> <tr><td>044</td><td>STONE GREY</td><td>ARGENTO</td><td>stone grey</td><td>silver</td></tr> <tr><td>066</td><td>NOCE PAVIA</td><td>ARGENTO</td><td>pavia walnut</td><td>silver</td></tr> <tr><td>403</td><td>ROVERE</td><td>BIANCO</td><td>oak</td><td>white</td></tr> <tr><td>404</td><td>ROVERE GREY</td><td>BIANCO</td><td>grey oak</td><td>white</td></tr> <tr><td>415</td><td>ACERO TAKI</td><td>BIANCO</td><td>taki maple</td><td>white</td></tr> <tr><td>425</td><td>GRIGIO</td><td>BIANCO</td><td>grey</td><td>white</td></tr> <tr><td>430</td><td>WENGE'</td><td>BIANCO</td><td>wengè</td><td>white</td></tr> <tr><td>440</td><td>BIANCO BR.</td><td>BIANCO</td><td>br. white</td><td>white</td></tr> <tr><td>444</td><td>STONE GREY</td><td>BIANCO</td><td>stone grey</td><td>white</td></tr> <tr><td>466</td><td>NOCE PAVIA</td><td>BIANCO</td><td>pavia walnut</td><td>white</td></tr> <tr><td>603</td><td>ROVERE</td><td>ANTRACITE</td><td>oak</td><td>anthracite</td></tr> <tr><td>604</td><td>ROVERE GREY</td><td>ANTRACITE</td><td>grey oak</td><td>anthracite</td></tr> <tr><td>615</td><td>ACERO TAKI</td><td>ANTRACITE</td><td>taki maple</td><td>anthracite</td></tr> <tr><td>625</td><td>GRIGIO</td><td>ANTRACITE</td><td>grey</td><td>anthracite</td></tr> <tr><td>630</td><td>WENGE'</td><td>ANTRACITE</td><td>wengè</td><td>anthracite</td></tr> <tr><td>640</td><td>BIANCO BR.</td><td>ANTRACITE</td><td>br. white</td><td>anthracite</td></tr> <tr><td>644</td><td>STONE GREY</td><td>ANTRACITE</td><td>stone grey</td><td>anthracite</td></tr> <tr><td>666</td><td>NOCE PAVIA</td><td>ANTRACITE</td><td>pavia walnut</td><td>anthracite</td></tr> </tbody> </table>	(*)	PIANO	BASE	top	base	003	ROVERE	ARGENTO	oak	silver	004	ROVERE GREY	ARGENTO	grey oak	silver	015	ACERO TAKI	ARGENTO	taki maple	silver	025	GRIGIO	ARGENTO	grey	silver	030	WENGE'	ARGENTO	wengè	silver	040	BIANCO BR.	ARGENTO	br. white	silver	044	STONE GREY	ARGENTO	stone grey	silver	066	NOCE PAVIA	ARGENTO	pavia walnut	silver	403	ROVERE	BIANCO	oak	white	404	ROVERE GREY	BIANCO	grey oak	white	415	ACERO TAKI	BIANCO	taki maple	white	425	GRIGIO	BIANCO	grey	white	430	WENGE'	BIANCO	wengè	white	440	BIANCO BR.	BIANCO	br. white	white	444	STONE GREY	BIANCO	stone grey	white	466	NOCE PAVIA	BIANCO	pavia walnut	white	603	ROVERE	ANTRACITE	oak	anthracite	604	ROVERE GREY	ANTRACITE	grey oak	anthracite	615	ACERO TAKI	ANTRACITE	taki maple	anthracite	625	GRIGIO	ANTRACITE	grey	anthracite	630	WENGE'	ANTRACITE	wengè	anthracite	640	BIANCO BR.	ANTRACITE	br. white	anthracite	644	STONE GREY	ANTRACITE	stone grey	anthracite	666	NOCE PAVIA	ANTRACITE	pavia walnut	anthracite
(*)	PIANO	BASE	top	base																																																																																																																																
003	ROVERE	ARGENTO	oak	silver																																																																																																																																
004	ROVERE GREY	ARGENTO	grey oak	silver																																																																																																																																
015	ACERO TAKI	ARGENTO	taki maple	silver																																																																																																																																
025	GRIGIO	ARGENTO	grey	silver																																																																																																																																
030	WENGE'	ARGENTO	wengè	silver																																																																																																																																
040	BIANCO BR.	ARGENTO	br. white	silver																																																																																																																																
044	STONE GREY	ARGENTO	stone grey	silver																																																																																																																																
066	NOCE PAVIA	ARGENTO	pavia walnut	silver																																																																																																																																
403	ROVERE	BIANCO	oak	white																																																																																																																																
404	ROVERE GREY	BIANCO	grey oak	white																																																																																																																																
415	ACERO TAKI	BIANCO	taki maple	white																																																																																																																																
425	GRIGIO	BIANCO	grey	white																																																																																																																																
430	WENGE'	BIANCO	wengè	white																																																																																																																																
440	BIANCO BR.	BIANCO	br. white	white																																																																																																																																
444	STONE GREY	BIANCO	stone grey	white																																																																																																																																
466	NOCE PAVIA	BIANCO	pavia walnut	white																																																																																																																																
603	ROVERE	ANTRACITE	oak	anthracite																																																																																																																																
604	ROVERE GREY	ANTRACITE	grey oak	anthracite																																																																																																																																
615	ACERO TAKI	ANTRACITE	taki maple	anthracite																																																																																																																																
625	GRIGIO	ANTRACITE	grey	anthracite																																																																																																																																
630	WENGE'	ANTRACITE	wengè	anthracite																																																																																																																																
640	BIANCO BR.	ANTRACITE	br. white	anthracite																																																																																																																																
644	STONE GREY	ANTRACITE	stone grey	anthracite																																																																																																																																
666	NOCE PAVIA	ANTRACITE	pavia walnut	anthracite																																																																																																																																

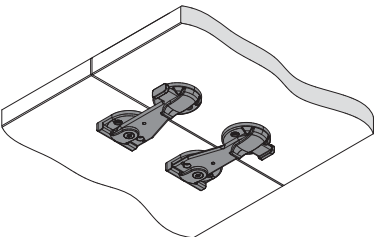
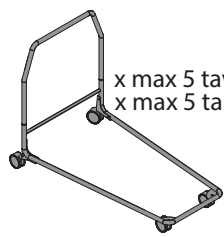
ACCESSORI PER TAVOLI accessories for tables							
DESCRIZIONE description	L w	CODICE code	KG	M <sup>3</sup>	COLLI PCS	PREZZO price	(*) CODICE FINITURA (*) finish code
AGGANCI IN NYLON PER IL COLLEGAMENTO TRA I PIANI hooks for tops connection  		CONF. 2 GANCI 2 hooks unit					
		175 641 (*)	0,2	0,002	1	€ 26,00	(*)
		CONF. 8 GANCI 8 hooks unit					
		175 642 (*)	0,2	0,002	1	€ 101,00	500 NERO black
CARRELLO PER TAVOLI CON GAMBE PIEGHEVOLI trolley for tables with folding legs   x max 5 tavoli x max 5 tables  L.127,7 x p.75,2 x H.98 w 50¼" x d 29¾" x h 38½"		175 644 (*)	10	0,120	1	€ 439,00	(*)
							500 NERO black

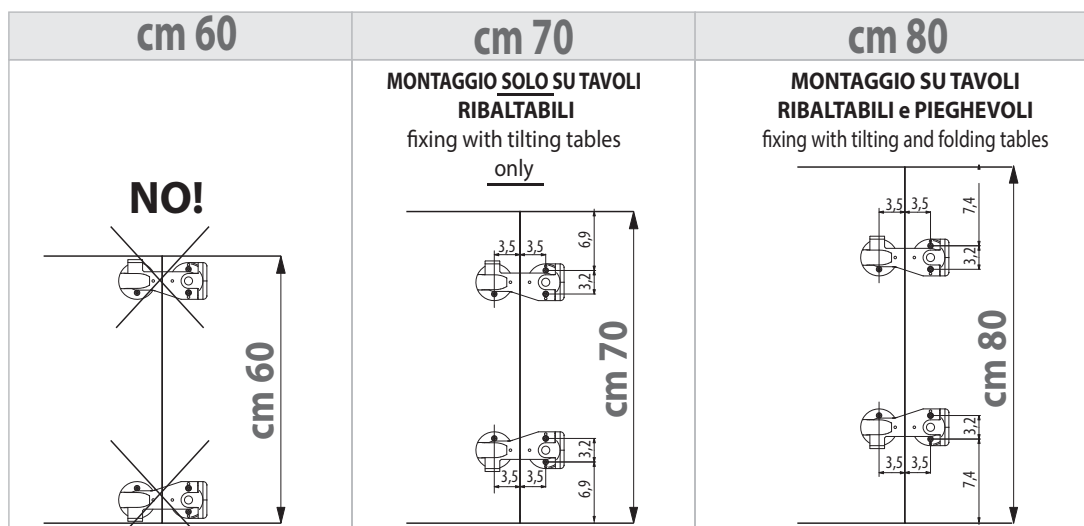
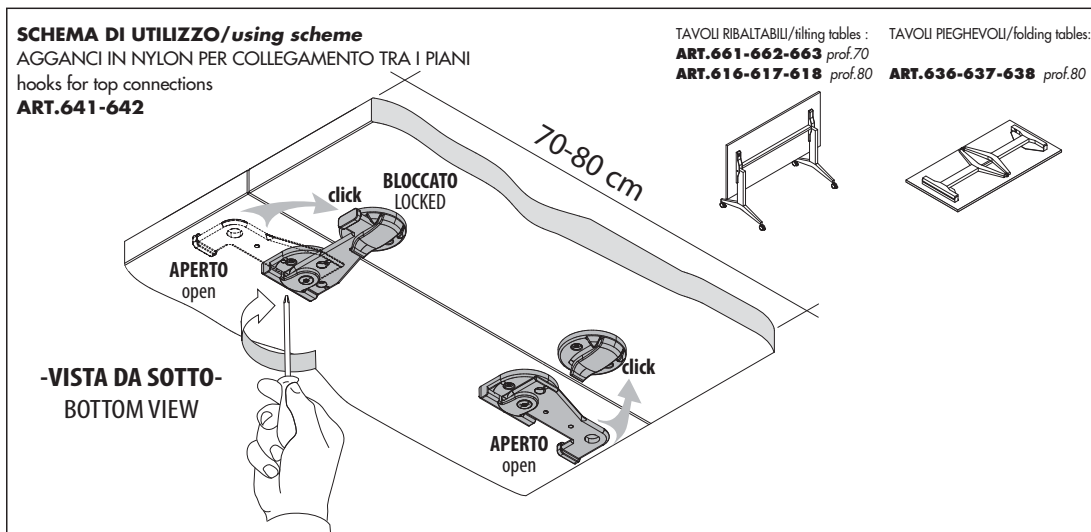

**DIMENSIONI**  
*dimensions*

**- TIPO 1 -  
TAVOLO CON PIANO RIBALTABILE**  
- TYPE 1 -  
table with tilting top

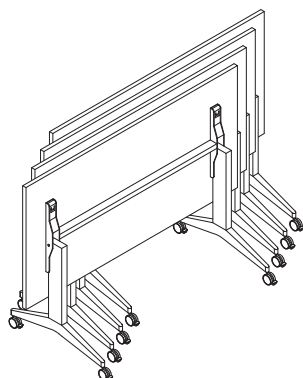
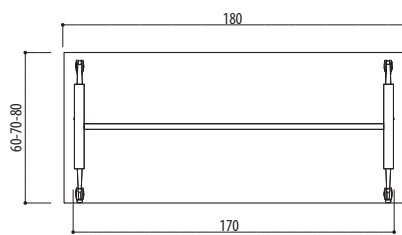
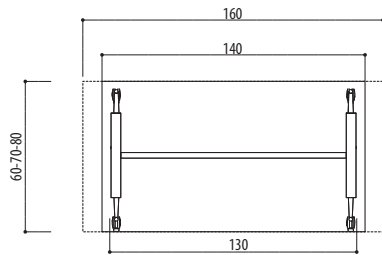
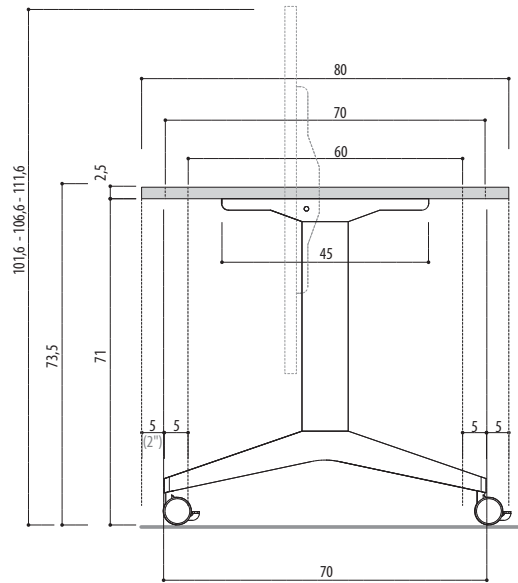

**- TIPO 2 -  
TAVOLO CON GAMBE PIEGHEVOLI**  
- TYPE 1 -  
table with folding legs

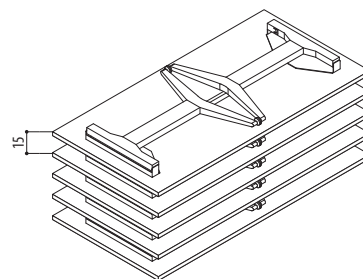
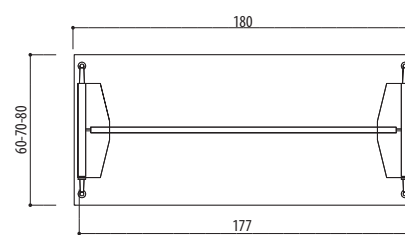
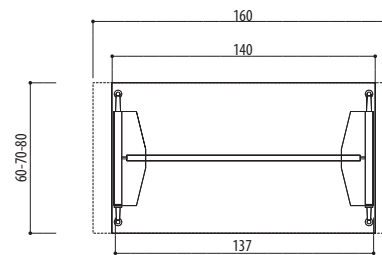
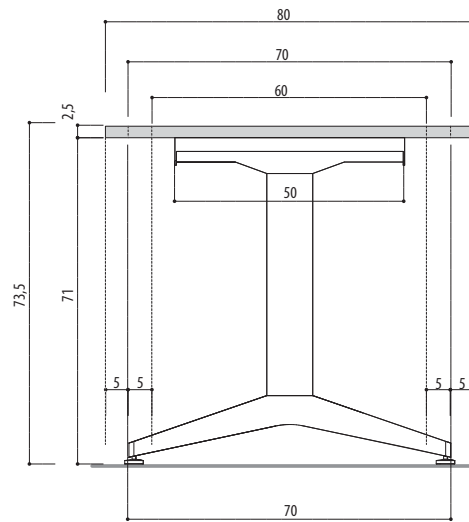

IMPILABILE MAX 5 pz.  
STACKABLE MAX 5 units

## **DESCRIZIONE TECNICA**

### **TIPO 1 ---- TAVOLO CON PIANO RIBALTABILE**

1 tavolo si compone di 2 gambe e 1 traversa.

Struttura estremamente solida che permette al singolo utilizzatore di movimentare il tavolo senza sforzo. Verniciata a polveri epossidiche , disponibile nelle seguenti finiture: ARGENTO METALLIZZATO RAL 9006 , BIANCO RAGGRINZATO RAL 9010 e ANTRACITE V132.

Comando di sblocco unico.

Il piano si blocca automaticamente in posizione verticale e in posizione da lavoro senza necessità di premere ulteriormente il comando di sblocco

I tavoli con piano ribaltato sono accatastabili frontalmente per un maggiore risparmio degli spazi.

La copertura della ruota può essere fornita in due nuance: grigio antracite e bianco

E' disponibile un kit di agganci sottopiano in Nylon per la aggregazione di tavoli .

Dimensioni in cm: L.140/160/180 x p.60-70-80 x H.73,5 (altezza fissa)

Certificazioni: Il tavolo e' testato secondo la norma EN1730:2000

#### **Specifiche tecniche:**

##### **Gambe:**

Basi: lamiera 25/10

Colonna verticale: tubo 100x40x2 mm

Ruote: Ø 60 mm con freno

##### **Traversa:**

Tubo rettangolare 50x30x1,5 mm

Lamiera 450x58x3mm.

##### **Piano:**

In pannello di particelle di Legno in Classe E1 di contenuto di Formaldeide , nobilitato melaminico spessore mm 25 bordato perimetralmente con bordo in ABS sp 2 mm in tinta con la superficie, disponibile nei colori: ROVERE 03, ROVERE GREY 04, NOCE PAVIA 06, GRIGIO 42, STONE GREY 44, WENGE' 45, ACERO TAKI 58, BIANCO BR. 69.

Inseriti in zama 8x13 passo metrico 6ma , per l'alloggiamento delle viti di fissaggio per la struttura.

### **TIPO 2 ---- TAVOLO CON GAMBE PIEGHEVOLI**

1 tavolo si compone di 2 gambe + 1traversa.

Il meccanismo delle gambe pieghevoli è robusto e pratico. Le gambe sono dotate di distanziatori antigraffio, inoltre sono fornite con livellatori Ø4 cm in polipropilene color antracite.

Struttura verniciata a polveri epossidiche , disponibile nelle seguenti finiture: ARGENTO METALLIZZATO RAL 9006 , BIANCO RAGGRINZATO RAL 9010 e ANTRACITE V132.

Comando di sblocco unico.

I tavoli possono essere accatastati e trasportati con un apposito carrello con struttura metallica per una maggiore ottimizzazione dei volumi.

E' disponibile un kit di agganci sottopiano in Nylon per la aggregazione di tavoli .

Dimensioni in cm: L.140/160/180 x p.60-70-80 x H.73,5 (altezza fissa)

( Tavoli di Lunghezza inferiore a cm 140 non sono tecnicamente realizzabili)

Certificazioni: Il tavolo e' testato secondo la norma EN1730:2000

#### **Specifiche tecniche:**

##### **Gambe:**

Basi: lamiera 25/10

Colonna verticale: tubo 100x40x2 mm

Piedini livellatori: Ø40mm in polipropilene color antracite

##### **Traversa:**

Tubo rettangolare 30x 20 x1,5 mm

##### **Piano:**

In pannello di particelle di legno in Classe E1 di contenuto di Formaldeide, nobilitato melaminico spessore mm 25 bordato perimetralmente con bordo in ABS sp 2 mm in tinta con la superficie, disponibile nei colori: ROVERE 03, ROVERE GREY 04, NOCE PAVIA 06, GRIGIO 42, STONE GREY 44, WENGE' 45, ACERO TAKI 58, BIANCO BR. 69.

Inseriti in zama 8x13 passo metrico 6ma , per l'alloggiamento delle viti di fissaggio per la struttura.

*I nostri prodotti sono realizzati seguendo gli standard di qualità più elevati e sono approvati dal nostro sistema di controllo qualità certificato ISO 9001.*

Emesso da Ufficio Tecnico LAS MOBILI

Data ultima revisione: GENNAIO 2018



## TECHNICAL DESCRIPTION

### TYPE 1 ---- TABLE WITH TILTING TOP

1 table consists of 2 legs and 1 crossbar.

Extremely solid structure that allows each user to move the table without effort. Epoxy powder coated, available in the following finishes: METALLIC SILVER RAL 9006 , WHITE RAL 9010 and ANTHRACITE V132.

Unique unlock command.

The top is automatically locked in the vertical position and in working position without the need to further press the unlock command.

The table tops are frontally stackable for greater space saving.

The wheel cover can be provided in two shades: dark grey and white

A kit with undertop Nylon hooks for the aggregation of tables is available separately.

Dimensions in cm: width 140/160/180 x **depth 60-70-80** x H.73, 5 (fixed height)

Certifications: The table is tested according to EN1730: 2000

#### Specifications:

##### Legs:

Bases: metal sheet 25/10

Vertical column: tube 100x40x2 mm

Wheels: Ø 60 mm with brake

##### Crossbar:

Rectangular tube 50x30x1,5 mm

Metal Sheet 450x58x3mm.

##### Table top:

In particleboard wood, in Class E1 formaldehyde content, thickness 25 mm with melamine facing and edging with ABS strip thickness 2 mm to match the surface, available in the colors: OAK 03, GREY OAK 04, PAVIA WALNUT 06 , GREY 42, STONE GREY 44, WENGE 45, TAKI MAPLE 58, BR. WHITE 69.

Inserts in zama 8x13 metric 6ma, for the housing of the fixing screws for the structure.

### TYPE 2 ---- TABLE WITH FOLDING LEGS

1 table consists of 2 legs + 1 crossbar

The mechanism of folding legs is sturdy and practical. The legs are fitted with spacers scratch-resistant, they are also provided with adjustable feet Ø 40mm polypropylene anthracite.

Structure painted with epoxy powder, available in the following finishes: METALLIC SILVER RAL 9006 , WHITE RAL 9010 and ANTHRACITE V132.

Unique unlock command.

The tables can be stacked and transported with a special trolley with a metal structure for increased optimization of the volumes.

A kit with undertop Nylon hooks for the aggregation of tables is available separately.

Dimensions in cm: width 140/160/180 x **depth 60-70-80** x H.73, 5 (fixed height)

(Tables of length less than 140 cm are not technically feasible)

Certifications: The table is tested according to EN1730: 2000

#### Specifications:

##### Legs:

Bases: metal sheet 25/10

Vertical column: 100x40x2 mm tube

Adjustable feet: Ø40mm polypropylene anthracite

##### Crossbar:

Rectangular Tube 30x 20 x1, 5 mm

##### Table top:

In particleboard wood , in Class E1 formaldehyde content, thickness 25 mm, with melamine facing an edging with ABS strip thickness 2 mm to match the surface, available in the colors: OAK 03, GREY OAK 04, PAVIA WALNUT 06 , GREY 42, STONE GREY 44, WENGE 45, TAKI MAPLE 58, BR. WHITE 69.

Inserts in zama 8x13 metric 6ma, for the housing of the fixing screws for the structure.

*Our products are manufactured according to highest quality standards and are approved by our quality control system ISO 9001 certified.*

Released by the Technical Office of LAS MOBILI

last revision date: JANUARY 2018

**INDICE DEI CODICI**  
*codes index*

\* = INDICARE IL CODICE FINITURA  
 = complete with finish code

INDICE DEI CODICI / codes index  
 Mod. TAVOLI - tables OYO

CODICE code	DESCRIZIONE description	PAG. page	PREZZO price
175 <b>611</b> *	TAVOLO RIBALTABILE L.140 x p.60 (RUOTE CON FRENO) tilting table w 140 x p.60 cms (wheels with brake)	4	€ <b>406,00</b>
175 <b>612</b> *	TAVOLO RIBALTABILE L.160 x p.60 (RUOTE CON FRENO) tilting table w 140 x p.60 cms (wheels with brake)	4	€ <b>412,00</b>
175 <b>613</b> *	TAVOLO RIBALTABILE L.180 x p.60 (RUOTE CON FRENO) tilting table w 180 x p.60 cms (wheels with brake)	4	€ <b>428,00</b>
175 <b>616</b> *	TAVOLO RIBALTABILE L.140 x p.80 (RUOTE CON FRENO) tilting table w 140 x p.80 cms (wheels with brake)	4	€ <b>415,00</b>
175 <b>617</b> *	TAVOLO RIBALTABILE L.160 x p.80 (RUOTE CON FRENO) tilting table w 140 x p.80 cms (wheels with brake)	4	€ <b>423,00</b>
175 <b>618</b> *	TAVOLO RIBALTABILE L.180 x p.80 (RUOTE CON FRENO) tilting table w 180 x p.80 cms (wheels with brake)	4	€ <b>439,00</b>
175 <b>631</b> *	TAVOLO PIEGHEVOLE L.140 x p.60 (CON PIEDINI) folding table w 140 x p.60 cms (with feet)	5	€ <b>310,00</b>
175 <b>632</b> *	TAVOLO PIEGHEVOLE L.160 x p.60 (CON PIEDINI) folding table w 160 x p.60 cms (with feet)	5	€ <b>316,00</b>
175 <b>633</b> *	TAVOLO PIEGHEVOLE L.180 x p.60 (CON PIEDINI) folding table w 180 x p.60 cms (with feet)	5	€ <b>323,00</b>
175 <b>636</b> *	TAVOLO PIEGHEVOLE L.140 x p.80 (CON PIEDINI) folding table w 140 x p.80 cms (with feet)	5	€ <b>319,00</b>
175 <b>637</b> *	TAVOLO PIEGHEVOLE L.160 x p.80 (CON PIEDINI) folding table w 160 x p.80 cms (with feet)	5	€ <b>327,00</b>
175 <b>638</b> *	TAVOLO PIEGHEVOLE L.180 x p.80 (CON PIEDINI) folding table w 180 x p.80 cms (with feet)	5	€ <b>334,00</b>
175 <b>641</b> *	KIT 2 GANCI 2 hooks unit	6	€ <b>26,00</b>
175 <b>642</b> *	KIT 8 GANCI 8 hooks unit	6	€ <b>101,00</b>
175 <b>644</b> *	CARRELLO PER TAVOLI PIEGHEVOLI trolley for folding tables	6	€ <b>439,00</b>
175 <b>661</b> *	TAVOLO RIBALTABILE L.140 x p.70 (RUOTE CON FRENO) tilting table w 140 x p.70 cms (wheels with brake)	4	€ <b>415,00</b>
175 <b>662</b> *	TAVOLO RIBALTABILE L.160 x p.70 (RUOTE CON FRENO) tilting table w 140 x p.70 cms (wheels with brake)	4	€ <b>423,00</b>
175 <b>663</b> *	TAVOLO RIBALTABILE L.180 x p.70 (RUOTE CON FRENO) tilting table w 180 x p.70 cms (wheels with brake)	4	€ <b>439,00</b>
175 <b>666</b> *	TAVOLO PIEGHEVOLE L.140 x p.70 (CON PIEDINI) folding table w 140 x p.70 cms (with feet)	5	€ <b>319,00</b>
175 <b>667</b> *	TAVOLO PIEGHEVOLE L.160 x p.70 (CON PIEDINI) folding table w 160 x p.70 cms (with feet)	5	€ <b>327,00</b>
175 <b>668</b> *	TAVOLO PIEGHEVOLE L.180 x p.70 (CON PIEDINI) folding table w 180 x p.70 cms (with feet)	5	€ <b>334,00</b>



**LISTINO** 2018  
PRICE LIST

# OYO

PANNELLI FONO-DINAMICI®  
sound-dynamic® panels



Certificato 04/16

**IMPORTANTE / it's very important**

SULL'ORDINE INDICARE SEMPRE IL CODICE COMPLETO A 9 CIFRE  
always indicate on the order the complete 9-digit code

ESEMPIO: PER ORDINARE 1 PANNELLO **ART.978** VERDE ACIDO INDICARE IL CODICE = **175** | **978** | **246**  
example: to order 1 PANEL **ART.978** ACID GREEN indicate the code =

DECODIFICA → MODELLO | ARTICOLO | CODICE FINITURA (\*)  
decoding → model | articolo | finish code (\*)

In vigore dal:  
Valid from:  
01/01/2018

Valido fino a nuova emissione  
Valid until new emission

SOUND-DYNAMIC®  
PANELS

**SOMMARIO / summary**

<b>CARTELLA COLORI PER PANNELLI FONO-DINAMICI</b> .....	<b>3</b>
<i>colours samples card for sound-dynamic panel</i>	
<b>CARTELLA COLORI PER MORSETTI E ACCESSORI</b> .....	<b>3</b>
<i>colours samples card for clamps and accessories</i>	
<b>PANNELLI FONO-DINAMICI PER SCRIVANIE</b> .....	<b>4</b>
<i>sound-dynamic panels for desks</i>	
<b>SCHEMA UTILIZZO MORSETTI</b> .....	<b>5</b>
<i>scheme of use clamps</i>	
<b>ACCESSORI PER PANNELLI FONO-DINAMICI</b> .....	<b>6</b>
<i>accessories for sound-dynamic panels</i>	
<b>DESCRIZIONE TECNICA</b> .....	<b>7</b>
<b>TECHNICAL DESCRIPTION</b> .....	<b>7</b>
<b>INDICE DEI CODICI</b> .....	<b>8</b>
<i>codes index</i>	

**PANNELLO FONO-DINAMICO E ACCESSORI**

*phono-dynamic panel and accessories*



**SU SCRIVANIA SINGOLA**

*on single desk*



**SU BENCH**

*on bench*

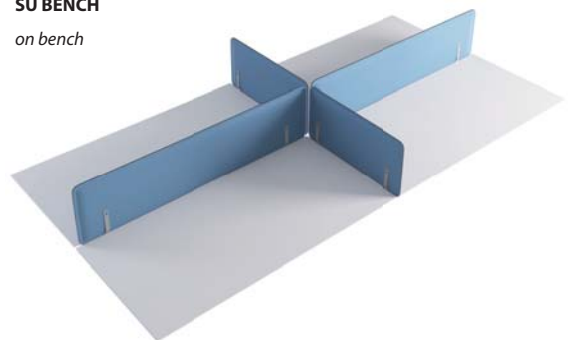

**DETTAGLIO SOSTEGNI**

*support detail*



**CARTELLA COLORI PER PANNELLI FONO-DINAMICI**  
*colours samples card for sound-dynamic panel*

Cat. C	 <b>TESSUTO CREP IGNIFUGO</b> 100% poliestere FR-TREVIRA CS Martindale 100.000	<b>FIRE-RETARDANT CREPE FABRIC</b> 100% polyester FR- TREVIRA CS Martindale 100.000		
				
	<b>243</b> NERO   BLACK	<b>246</b> VERDE ACIDO   ACID GREEN	<b>249</b> GIALLO   YELLOW	<b>250</b> ROSSO   RED
				
	<b>251</b> ARANCIO   ORANGE	<b>253</b> AZZURRO   AZURE	<b>254</b> CELESTE   LIGHT BLUE	<b>257</b> AVORIO   IVORY
		<b>258</b> GRIGIO PERLA   LIGHT GREY		

**CARTELLA COLORI PER MORSETTI E ACCESSORI**  
*colours samples card for clamps and accessories*



**COD. AR 02**  
**ARGENTO | SILVER**  
Oxi - 5<sup>th</sup> Element



**COD. AN 02**  
**ANTRACITE | ANTHRACITE**  
5<sup>th</sup> Element - Contenitori Universali Evo - Oyo - I Meet

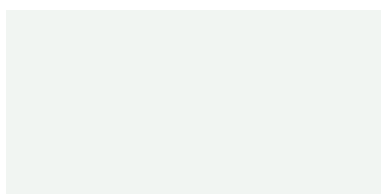

**COD. BI 02** (RAL 9016)  
**BIANCO | WHITE**  
Oxi - 5<sup>th</sup> Element - Enosi Evo

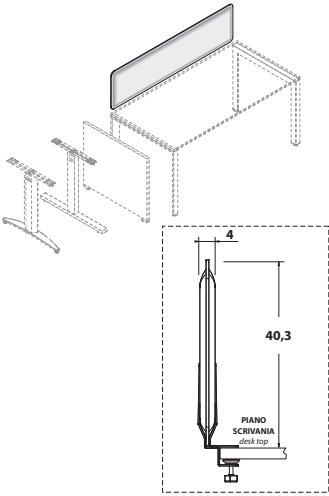
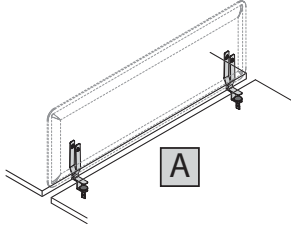
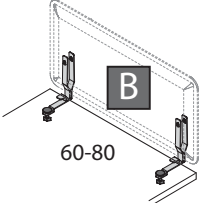
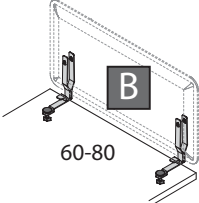
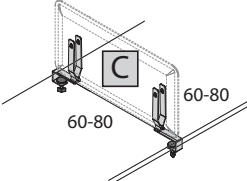
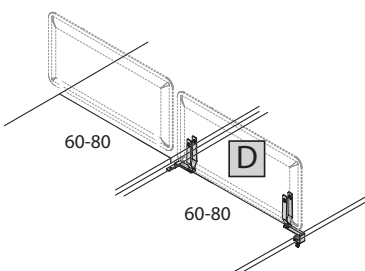

**COD. SG 01**  
**STONE GREY | STONE GREY**  
Oxi - 5<sup>th</sup> Element - Contenitori Universali Evo - Oyo - I Meet

PANNELLI FONO-DINAMICI PER SCRIVANIE sound-dynamic panels for desks								
DESCRIZIONE description	L w	CODICE code	KG	M <sup>3</sup>	COLLI	PREZZO price	(*) CODICE FINITURA (*) finish code	
PANNELLI FONO-DINAMICI sound-dynamic panels   L. x p.4 x H.40	<b>TESSUTO fabric</b>							
	L.60	175 974 (*)	1	0,010	1	€ 136,00	(*)	
	L.80	175 975 (*)	1,3	0,014	1	€ 138,00	243	
	L.100	175 976 (*)	1,6	0,018	1	€ 162,00	245	
	L.120	175 977 (*)	1,9	0,022	1	€ 167,00	246	
	L.140	175 978 (*)	2,2	0,026	1	€ 180,00	249	
	L.160	175 979 (*)	2,5	0,030	1	€ 182,00	250	
	L.180	175 980 (*)	2,8	0,034	1	€ 214,00	251	
	<b>DA COMPLETARE SEMPRE CON 1 KIT MORSETTI PER SCHEMA DI UTILIZZO VEDI PAGINA SEGUENTE</b> <i>to be always complete with 1 set of clamps for scheme of use, please see next page</i>							253
								254
							257	
							258	
KIT 2 MORSETTI PER PANNELLO FRONTALE set of 2 clamps for front panel   <b>A</b>	<b>PER PIANI SPESS. 18-25mm for top thick. 18-25mm</b>							
		175 992 (*)	1	0,004	1	€ 61,00		
KIT 2 MORSETTI PER PANNELLO TERMINALE set of 2 clamps for end panel   <b>B</b> 60-80	<b>PER PIANI SPESS. 18mm for top thick. 18mm</b>							
		175 993 (*)	1	0,004	1	€ 64,00		
KIT 2 MORSETTI PER PANNELLO TERMINALE set of 2 clamps for end panel   <b>B</b> 60-80	<b>PER PIANI SPESS. 25mm for top thick. 25mm</b>							
		175 994 (*)	1	0,004	1	€ 65,00		
KIT 2 MORSETTI PER PANNELLO CENTRALE SU SCRIVANIE IN LINEA set of 2 clamps for central panel for desk in line   <b>C</b> 60-80	<b>PER PIANI SPESS. 18-25mm for top thick. 18-25mm</b>							
		175 995 (*)	1	0,004	1	€ 68,00	(*)	
KIT 2 MORSETTI PER PANNELLO CENTRALE SU BENCH (SOLO 5 <sup>TH</sup> ELEMENT) set of 2 clamps for central panel on bench (for 5th element only)   <b>D</b> 60-80	<b>PER PIANI SPESS. 18-25mm for top thick. 18-25mm</b>							
		175 996 (*)	1	0,004	1	€ 51,00	000	
<b>MONTAGGIO SU GAMBA CENTRALE BENCH MOD. 5<sup>TH</sup> ELEMENT</b> <i>assembling on central leg of the bench Mod.5th ELEMENT only!</i>							440	
							551	
							844	
							ARGENTO	
							BIANCO	
							ANTRACITE	
							STONE GREY	
							silver	
							white	
							anthracite	
							stone grey	



**PANNELLI E MORSETTI NON UTILIZZABILI SU PIANI SCORREVOLI!**  
Do not use the panels and clamps on sliding tops!

**SCHEMA UTILIZZO MORSETTI**

scheme of use clamps

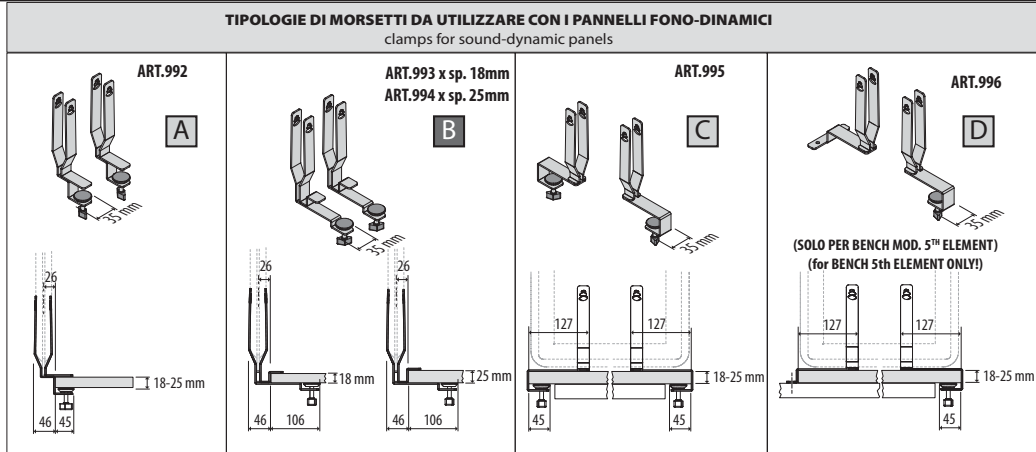

**MODELLI DOVE SI POSSONO UTILIZZARE**

Models where you can use them

UP

SCRIVANIE CON GAMBE A "PONTE"  
desks with "BRIDGE" metal legs

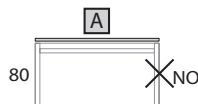
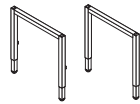

SCRIVANIE CON GAMBE A "T"  
desks with "T" metal legs

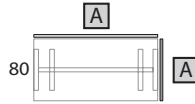
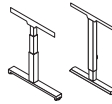

BENCH

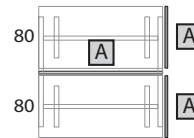
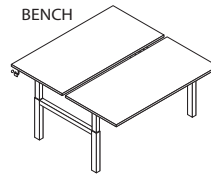

LOGIC

SCRIVANIE CON FIANCHI LEGNO O GAMBE METALLICHE  
desks with side panels or metal legs

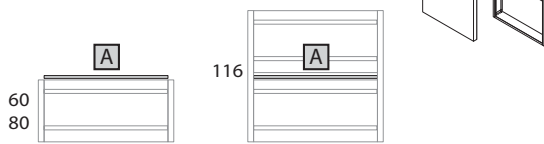

OXI

SCRIVANIE CON BASAMENTO LEGNO  
desks with panel base

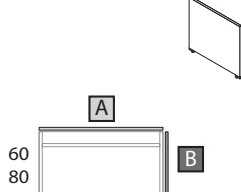

SCRIVANIE CON GAMBE A "T"  
desks with "T" metal legs

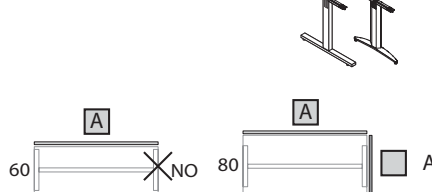

BENCH SU COMBY  
bench on comby

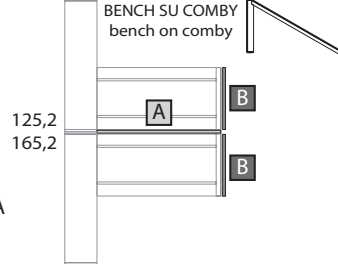

OXI - 5<sup>TH</sup> ELEMENT

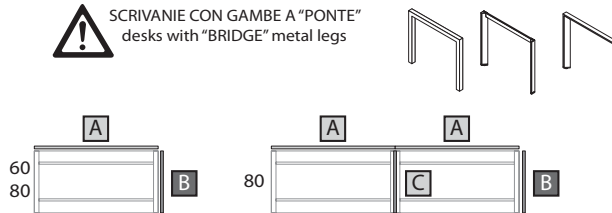

**!** SCRIVANIE CON GAMBE A "PONTE"  
desks with "BRIDGE" metal legs

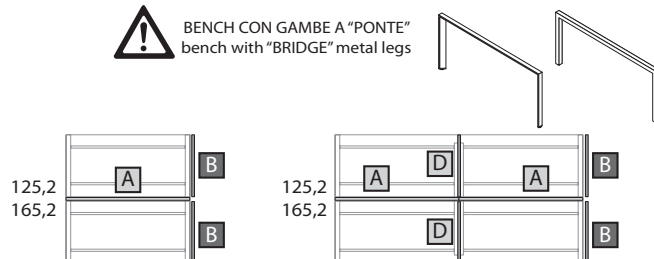

**!** BENCH CON GAMBE A "PONTE"  
bench with "BRIDGE" metal legs

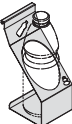
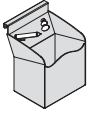

**!** **B C D** PANNELLI E MORSETTI NON UTILIZZABILI SU PIANI SCORREVOLI!  
Do not use the panels and clamps on sliding tops!

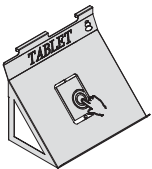
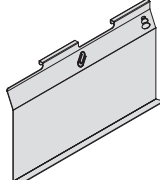
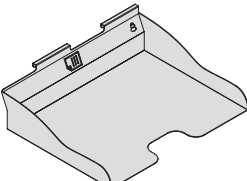
ACCESSORI PER PANNELLI FONO-DINAMICI							
accessories for sound-dynamic panels							
DESCRIZIONE description	L w	CODICE code	KG	M <sup>3</sup>	COLLI	PREZZO price	(*) CODICE FINITURA (*) finish code
PORTA-FIORE CON PROVETTA flower-holder with tube  L.4 x p.10,6 x H.14,8		175 963 (*)	0,3	0,003	1	€ 29,00	
PORTA-BOTTIGLIA bottle-holder  L.8 x p.10,6 x H.18,9		175 964 (*)	0,3	0,003	1	€ 28,00	
PORTA-PENNE pen-holder  L.8,2 x p.8 x H.11		175 965 (*)	0,3	0,003	1	€ 28,00	
PORTA-CELLULARE smartphone-holder  L.16,4 x p.7 x H.12		175 966 (*)	0,3	0,003	1	€ 30,00	
PORTA-TABLET tablet-holder  L.25 x p.17,3 x H.19		175 967 (*)	1,5	0,025	1	€ 35,00	
LAVAGNA METALLICA metallic board  L.33 x p.4,1 x H.19		175 968 (*)	1,5	0,025	1	€ 35,00	
PORTA-CARTA A4 A4 paper-holder  L.33,2 x p.27,3 x H.8,6		175 969 (*)	1,5	0,025	1	€ 35,00	

(*)		
000	ARGENTO	silver
440	BIANCO	white
551	ANTRACITE	anthracite
844	STONE GREY	stone grey



## DESCRIZIONE TECNICA

### PANNELLI ACUSTICI

I pannelli fono-dinamici® sono realizzati in fibra di poliestere riciclata con densità 3000 gr/m<sup>2</sup>, spessore 40 mm, termoformata con bordi tagliati a laser.

I pannelli sono rivestiti con tessuto bi-elastico stretch CREP "TREVIRA CS".

### SUPPORTI

I supporti desking sono realizzati in lamiera d'acciaio 30/10 saldata e presso piegata, verniciata con polveri epossidiche con incisioni e tagli al laser. Disponibili nei colori: ARGENTO, BIANCO, ANTRACITE, STONE GREY.

### ACCESSORI

Sono realizzati in lamiera d'acciaio 10/10, presso-piegata con tagli ed incisioni al laser e verniciate con polveri epossidiche. Disponibili nei colori: ARGENTO, BIANCO, ANTRACITE, STONE GREY.

## TECHNICAL DESCRIPTION

### ACOUSTIC PANELS

The sound-dynamic® panels are made by 3000 gr/m<sup>2</sup> density recycled polyester fiber, 40mm thick., thermoformed with laser cut edge. Panels are coated with double stretch fabric CREPE "TREVIRA CS".

### SUPPORTS

Desks supports are made by 30/10 steel foil welded and press formed, painted with epoxy resin powder with laser cut and engravings. Available in colours: SILVER, WHITE, ANTHRACITE, STONE GREY.

### ACCESSORIES

Desks supports are made by 10/10 press formed steel foil, painted with epoxy resin powder with laser cut and engravings. Available in colours: SILVER, WHITE, ANTHRACITE, STONE GREY.

## CARATTERISTICHE TECNICHE DEL TESSUTO

### Fabric technical description

# TESSUTO CREP IGNIFUGO

## Fire-retardant Crepe Fabric

Certificato Classe 1 Ministero dell'Interno



**COMPOSIZIONE:**  
**composition:**

100% PL Poliestere FR - Trevira CS  
100% PL Polyester FR - Trevira CS

**PESO:**  
**weight:**

gr./m<sup>2</sup> 330 ± 10%  
gr./m<sup>2</sup> 330 ± 10%

**ABRASIONE:**  
**abrasion test:**

Test Martindale UNI EN ISO 12947:2000 100.000 cicli ± 20%  
Martindale Test UNI EN ISO 12947:2000 100.000 turns ± 20%

**SOLIDITÀ LUCE:**  
**lightfastness:**

XENOTEST UNI EN ISO 105 B02 5 ± 1

**PULIZIA:**  
**cleaning:**

Usare con regolarità l'aspirapolvere a beccuccio liscio, senza spazzolare  
Use the vacuum-cleaner with spout regularly, don't brush

**LAVAGGIO:**  
**washing:**



**OMOLOGAZIONI:**  
**approvals:**

Le proprietà ignifughe sono intrinseche nella fibra e non da trattamenti aggiuntivi  
The flame-retardant properties are inherent to the fibre and are not provided by additional treatments

- I** Classe 1
- F** M1
- D** B1 DIN 4102
- GB** BS 5852 Crib 5 using a CM Foam 35 kg/cu.m
- EN** 1021 Part. 1-2 using a CM Foam 35 kg/cu.m
- EN** 13773 Burning Behaviour: class 1
- EN** 13501-1 esp 1,2: B-s, d0
- A** Q1 (OENORM 3800 Part.1)
- A** B1 (OENORM B 3825)

(I dati riportati nella presente scheda tecnica, anche se riportati con la migliore approssimazione possibile, sono da considerarsi tuttavia indicativi)  
(The data reported in this technical sheet, even though reported with best possible approximation, should however be considered indicative)

**INDICE DEI CODICI**  
codes index

INDICE DEI CODICI / codes index  
Mod. OYO- PANNELLI FONO-DINAMICI  
Mod. OYO- SOUND DYNAMIC PANELS

\* = INDICARE IL CODICE FINITURA  
= complete with finish code

CODICE code	DESCRIZIONE description	PAG. page	PREZZO price
175 <b>963</b> *	PORTA-FIORE CON PROVETTA flower-holder with tube	6	€ <b>29,00</b>
175 <b>964</b> *	PORTA-BOTTIGLIA bottle-holder	6	€ <b>28,00</b>
175 <b>965</b> *	PORTA-PENNE pen-holder	6	€ <b>28,00</b>
175 <b>966</b> *	PORTA-CELLULARE smartphone-holder	6	€ <b>30,00</b>
175 <b>967</b> *	PORTA-TABLET tablet-holder	6	€ <b>35,00</b>
175 <b>968</b> *	LAVAGNA METALLICA metallic board	6	€ <b>35,00</b>
175 <b>969</b> *	PORTA-CARTA A4 A4 paper-holder	6	€ <b>35,00</b>
175 <b>974</b> *	PANNELLO FONO-DINAMICO L.60 sound-dynamic panel w 60 cms	4	€ <b>136,00</b>
175 <b>975</b> *	PANNELLO FONO-DINAMICO L.80 sound-dynamic panel w 80 cms	4	€ <b>138,00</b>
175 <b>976</b> *	PANNELLO FONO-DINAMICO L.100 sound-dynamic panel w 100 cms	4	€ <b>162,00</b>
175 <b>977</b> *	PANNELLO FONO-DINAMICO L.120 sound-dynamic panel w 120 cms	4	€ <b>167,00</b>
175 <b>978</b> *	PANNELLO FONO-DINAMICO L.140 sound-dynamic panel w 140 cms	4	€ <b>180,00</b>
175 <b>979</b> *	PANNELLO FONO-DINAMICO L.160 sound-dynamic panel w 160 cms	4	€ <b>182,00</b>
175 <b>980</b> *	PANNELLO FONO-DINAMICO L.180 sound-dynamic panel w 180 cms	4	€ <b>214,00</b>
175 <b>992</b> *	KIT 2 MORSETTI PER PANNELLO FRONTALE set of 2 clamps for front panel	A 4	€ <b>61,00</b>
175 <b>993</b> *	KIT 2 MORSETTI PER PANNELLO TERMINALE (PER PIANI SP.MM 18) set of 2 clamps for end panel (for desktop with thick.18mm)	B 4	€ <b>64,00</b>
175 <b>994</b> *	KIT 2 MORSETTI PER PANNELLO TERMINALE (PER PIANI SP.MM 25) set of 2 clamps for end panel (for desktop with thick.18mm)	B 4	€ <b>65,00</b>
175 <b>995</b> *	KIT 2 MORSETTI PER PANNELLO CENTRALE PER SCRIVANIE IN LINEA set of 2 clamps for central panes for desk in line	C 4	€ <b>68,00</b>
175 <b>996</b> *	KIT 2 MORSETTI PER PANNELLO CENTRALE PER BENCH set of 2 clamps for central panel for bench	D 4	€ <b>51,00</b>



**LISTINO** 2018  
PRICE LIST

# OYO

ACCESSORI  
accessories



**IMPORTANTE / it's very important**

SULL'ORDINE INDICARE SEMPRE IL CODICE COMPLETO A 9 CIFRE  
always indicate on the order the complete 9-digit code

ESEMPIO: PER ORDINARE 1 LAMPADA **ART.753** ARGENTO INDICARE IL CODICE = **175** **753** **000**  
example: to order 1 LAMP **ART.753** WENGE indicate the code =

DECODIFICA → MODELLO ARTICOLO CODICE FINITURA (\*)  
decoding → model articolo finish code (\*)

LE MISURE IN INCHES SONO APPROSSIMATE  
the dimensions in inches are approximate

In vigore dal:  
Valid from:  
01/02/2017

Valido fino a nuova emissione  
Valid until new emission



**SOMMARIO / summary**

<b>CARTELLA COLORI PER PANNELLI FRONTALI</b> .....	<b>4</b>
<i>colours samples card for front panel</i>	
<b>PANNELLI FRONTALI CON CAVA ATTREZZABILE</b> .....	<b>5</b>
<i>front panels with accessories toolbars</i>	
<b>ACCESSORI PER PANNELLI FRONTALI (per art. da 483 a 496)</b> .....	<b>5</b>
<i>accessories for front panels (for art. from 483 till 496)</i>	
<b>PORTA PC-TOWER e COMPLEMENTI PER UFFICIO</b> .....	<b>8</b>
<i>PC-tower supports and complements for office</i>	
<b>REGGI-CARTELLE e RIPIANI IN METALLO PER CONTENITORI</b> .....	<b>10</b>
<i>folder-supports and metal shelves for cabinets</i>	
<b>ADATTATORI REGGI-CARTELLE PER CLASSIFICATORI e COMPLEMENTI PER CONTENITORI</b> .....	<b>11</b>
<i>file support fits for file-drawers and complements for cabinets</i>	
<b>KIT CILINDRO SERRATURA PER CHIAVI UGUALI</b> .....	<b>12</b>
<i>cylinder lock kit for keys alike</i>	
<b>STAFFE</b> .....	<b>12</b>
<i>stirrups</i>	
<b>PASSACAVI, FRESE PER FORATURA E PRESA AD INCASSO</b> .....	<b>13</b>
<i>cable-way , millers for holes and built-in socket</i>	
<b>CANALINE PER ELETRIFICAZIONE</b> .....	<b>14</b>
<i>channeled bar for desks</i>	
<b>CANALI PORTA-CAVI E KIT PER ELETRIFICAZIONE</b> .....	<b>15</b>
<i>cable channels and electrification kit</i>	
<b>KIT ELETRIFICAZIONE tipo K1 (BACHMANN)</b> .....	<b>16</b>
<i>electrification kit type K1 (by Bachmann)</i>	
<b>KIT ELETRIFICAZIONE tipo K2 (BACHMANN)</b> .....	<b>16</b>
<i>electrification kit type K2 (by Bachmann)</i>	
<b>MODULI PERSONALIZZABILI (BACHMANN)</b> .....	<b>16</b>
<i>customizable modules (by Bachmann)</i>	
<b>KIT ELETRIFICAZIONE tipo Y3</b> .....	<b>17</b>
<i>electrification kit type Y3</i>	
<b>SCHEMA DI UTILIZZO KIT ELETRIFICAZIONE</b> .....	<b>17</b>
<i>scheme of use electrification kit</i>	
<b>INDICE DEI CODICI</b> .....	<b>18</b>
<i>codes index</i>	

**CARTELLA COLORI PER PANNELLI FRONTALI**

colours samples card for front panel

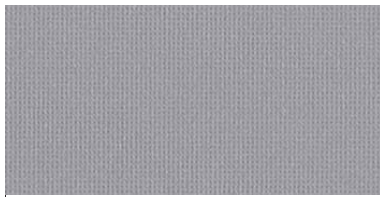

COD. 01  
ARGENTO GOLF | GOLF SILVER



COD. 06  
NOCE PAVIA | PAVIA WALNUT



COD. 55  
ANTRACITE | ANTHRACITE



COD. 03  
ROVERE | OAK



COD. 44  
STONE GREY | STONE GREY



COD. 58  
ACERO TAKI | TAKI MAPLE



COD. 04  
ROVERE GREY | GREY OAK



COD. 45  
WENGÉ | WENGÉ

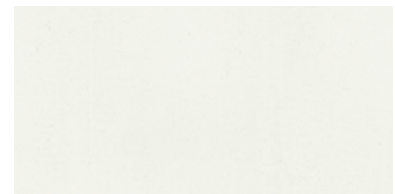

COD. 69  
BIANCO BR. | BR. WHITE

**RIVESTIMENTI IN TESSUTO PER PANNELLI FRONTALI**  
fabric for front panels

Cat. F



**POLIESTERE STRETCH IGNIFUGO**  
100% poliestere FR riciclato  
Martindale 50.000

**FIRE-RETARDANT STRETCH POLYESTER**  
100% polyester FR recycled  
Martindale 50.000

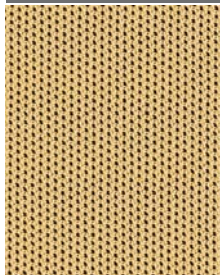

321  
GIALLO FRESIA | FREESIA YELLOW



320  
AZZURRO SKY | SKY BLUE



322  
AMARANTO | AMARANTH



323  
VERDE BOSCO | WOOD GREEN



327  
GRIGIO | GREY

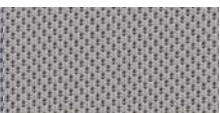

328  
TORTORA | GREY BEIGE



330  
MATTONE | BRICK RED

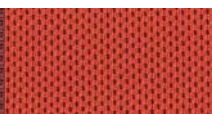

331  
ARANCIO | ORANGE

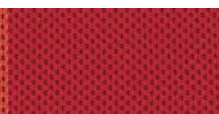

332  
ROSSO | RED







333  
VERDE ACIDO | ACID GREEN



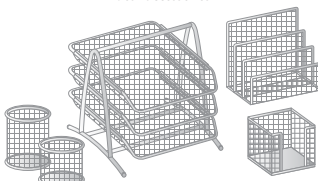
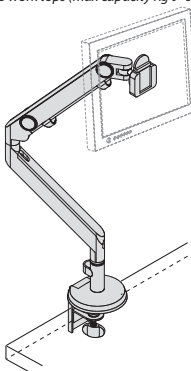
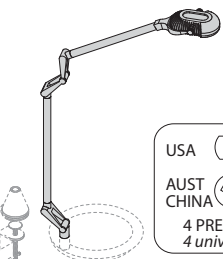

334  
BLU | BLUE

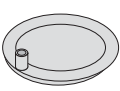
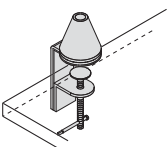



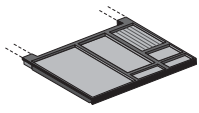
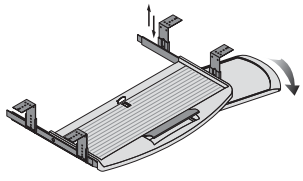
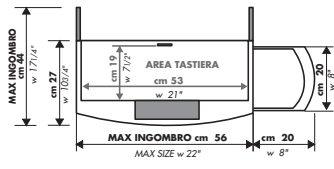
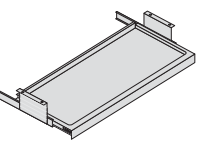
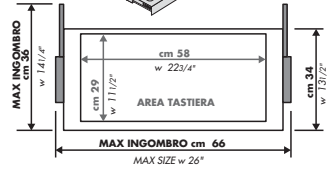

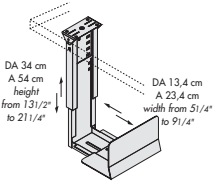
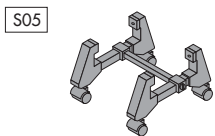
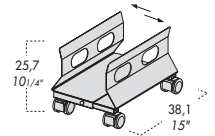
COMPLEMENTI PER SCRIVANIE complements for desks							
DESCRIZIONE description	L w	CODICE code	KG	M <sup>3</sup>	COLLI	PREZZO price	(*) CODICE FINITURA (*) finish code
<p>ACCESSORI SCRIVANIA desk accessories</p> 		175 181 (*)	0,2	0,030	1	€ 51,00	(*) 000 ARGENTO silver
<p>BRACCIO SNODATO PORTA-VIDEO CON MORSETTO PER ANCORAGGIO A PIANI DI LAVORO (PORTATA MAX. KG 9- DIMENSIONI DA 15" A 23") articulated rotating video stand arm-clamp for fixing to work tops (max capacity Kg 9- sizes 15"-23")</p> 		175 362 (*)	3	0,006	1	€ 263,00	
<p>LAMPADA A LED - 5 Watt (con 4 prese universali intercambiabili) led lamp - 5 Watt (4 interchangeable plugs)</p>  <p>USA  EU  AUST  CHINA  4 PRESE UNIVERSALI 4 universal plugs</p> <p>MORSETTO O BASE clamp or base</p> <p>↔</p>		175 753 (*)	0,8	0,002	1	€ 387,00	(*) 000 ARGENTO silver
	<b>COMPLETARE SEMPRE CON BASE ART.349 OPPURE MORSETTO ART.361</b> always complete with base art.349 or clamp art.361						
<p>BASE PER LAMPADA ART.753 base for lamp art.753</p>  <p>Ø 23</p>		175 349 (*)	1	0,002	1	€ 55,00	
<p>MORSETTO PER ANCORAGGIO LAMPADA ART.753 A PIANI DI LAVORO clamp for fixing lamp art.753 to work tops</p> 		175 361 (*)	0,5	0,002	1	€ 38,00	

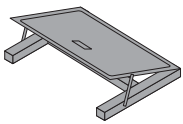

COMPLEMENTI PER SCRIVANIE complements for desks							
DESCRIZIONE description	L w	CODICE code	KG	M <sup>3</sup>	COLLI	PREZZO price	(*) CODICE FINITURA (*) finish code
CASSETTO IN PLASTICA PORTA-CANCELLERIA SOTTOPIANO stationery plastic drawers under the desk top    L.54 x p.39 x H.4		175 188 (*)	4	0,014	1	€ 86,00	(*) 500 NERO black
PORTA-TASTIERA ESTRAIBILE L.56 REGOLABILE IN ALTEZZA COMPLETO DI MENSOLA PORTA-MOUSE w 22" pull-out keyboard tray height adjustable with mouse- holder shelf    		175 082 (*)	3	0,011	1	€ 61,00	(*) 300 GRIGIO grey
PORTA-TASTIERA ESTRAIBILE L.58 w 22 3/4" pull-out keyboard tray  S09/R-58    		175 222 (*)	4	0,025	1	€ 102,00	(*) 000 ARGENTO silver 500 NERO black

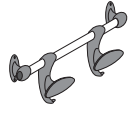
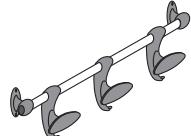
PORTA PC-TOWER e COMPLEMENTI PER UFFICIO							
PC-tower supports and complements for office							
DESCRIZIONE description	L w	CODICE code	KG	M <sup>3</sup>	COLLI	PREZZO price	(*) CODICE FINITURA (*) finish code
SUPPORTO PER PC-TOWER SOTTOPIANO REGOLABILE <i>undertop support adjustable sizes for PC-tower</i>   <p>DA 34 cm A 54 cm height from 13 1/2" to 21 1/4"</p> <p>DA 13,4 cm A 23,4 cm width from 5 1/4" to 9 1/4"</p>		175 081 (*)	4,6	0,012	1	€ 88,00	(*) 000 ALLUMINIO aluminium
SUPPORTO PER PC-TOWER INDIPENDENTE CON RUOTE <i>separate trolley with wheels for vertical PC-tower</i>   <p>S05</p> <p>LARGHEZZA INTERNA VARIABILE DA 13 A 23 cm  <i>adjustable internal width from 13 to 23 cm</i></p>		175 050 (*)	3	0,009	1	€ 83,00	(*) 500 NERO black
SUPPORTO PER PC-TOWER INDIPENDENTE CON RUOTE <i>separate trolley with wheels for vertical PC-tower</i>   <p>25,7 10 1/4"</p> <p>38,1 15"</p> <p>LARGHEZZA INTERNA VARIABILE DA 18,7 A 23,2 cm  <i>adjustable internal width from 7 1/4" to 9 1/4"</i></p>		175 217 (*)	4	0,036	1	€ 62,00	(*) 000 ARGENTO silver 450 BIANCO white 551 ANTRACITE anthracite 844 STONE GREY stone grey
CESTINO <i>wastebasket</i>   <p>Ø29,5 x H.34,5</p>		175 180 (*)	0,2	0,020	1	€ 19,00	(*) 000 ARGENTO silver
POGGIPIEDI <i>foot-rest</i>   <p>L.45 x p.35 x H.9-12</p>		175 161 (*)	6	0,010	1	€ 60,00	(*) 500 NERO black

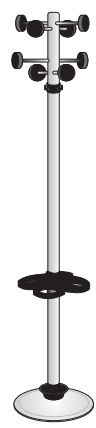
<b>COMPLEMENTI PER UFFICIO</b> <i>complements for office</i>							
<b>DESCRIZIONE</b> <i>description</i>	<b>L</b> <i>w</i>	<b>CODICE</b> <i>code</i>	<b>KG</b> 	<b>M<sup>3</sup></b> 	<b>COLLI</b> 	<b>PREZZO</b> <i>price</i>	<b>(*) CODICE FINITURA</b> <i>(*) finish code</i>
PORTA-ABITI 2 POSTI <i>(2 hooks) clothes hanger</i>    L.35		175 172 (*)	0,7	0,003	1	€ 66,00	
PORTA-ABITI 3 POSTI <i>(3 hooks) clothes hanger</i>    L.52		175 173 (*)	1	0,005	1	€ 83,00	
PORTA-ABITO A STELO <i>clothes-tree</i>    Ø 34 x H.170		175 182 (*)	7	0,028	1	€ 151,00	
							(*) 500 NERO - CROMATO <i>black - chromed</i>
PORTA-ABITO A STELO <i>clothes-tree</i>    Ø 36 x H.178		175 183 (*)	7	0,028	1	€ 110,00	

**REGGI-CARTELLE e RIPIANI IN METALLO PER CONTENITORI**

*folder-supports and metal shelves for cabinets*

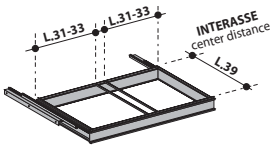
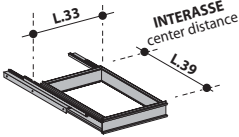
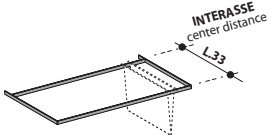
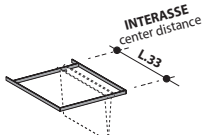
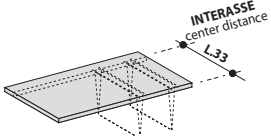
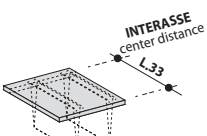
DESCRIZIONE <i>description</i>	L <i>w</i>	CODICE <i>code</i>	KG	M <sup>3</sup>	COLLI	PREZZO <i>price</i>	(*) CODICE FINITURA <i>(*) finish code</i>
REGGI-CARTELLE ESTRAIBILE L.90 <i>pull-out folders support w 90 cms</i>  L.90		175 096 (*)	4	0,039	1	€ 139,00	
REGGI-CARTELLE ESTRAIBILE L.45 <i>pull-out folders support w 45 cms</i>  L.45		175 097 (*)	3	0,020	1	€ 118,00	
REGGI-CARTELLE FISSO L.90 <i>fixed folders support w 90 cms</i>  L.90		175 098 (*)	3	0,014	1	€ 42,00	(*)
REGGI-CARTELLE FISSO L.45 <i>fixed folders support w 45 cms</i>  L.45		175 099 (*)	2	0,006	1	€ 30,00	500 NERO black
RIPIANO IN METALLO PER MOBILI L.90 <i>metal shelf for cabinets w 90 cms</i>  L.86,2 x p. 40,6 x H.2,5		175 131 (*)	4	0,018	1	€ 46,00	(*)
RIPIANO IN METALLO PER MOBILI L.45 <i>metal shelf for cabinets w 45 cms</i>  L.41,2 x p. 40,6 x H.2,5		175 132 (*)	2	0,009	1	€ 35,00	000 ARGENTO silver 450 BIANCO white 551 ANTRACITE anthracite 844 STONE GREY stone grey

**ADATTATORI REGGI-CARTELLE PER CLASSIFICATORI e COMPLEMENTI PER CONTENITORI**

file support fits for file-drawers and complements for cabinets

DESCRIZIONE description	L w	CODICE code	KG	M <sup>3</sup>	COLLI	PREZZO price	(*) CODICE FINITURA (*) finish code		
1 ADATTATORE PER CLASSIFICATORI (PER VARI FORMATI DI CARTELLE) 1 fit for file-drawers (for different files sizes)    L.33		175 137 (*)	0,2	0,001	1	€ 11,00	(*)		
	PER UTILIZZO VEDI SCHEMA SOTTO for using, please see scheme below							500	NERO

**SU CASSETTIERE CON CASSETTI IN METALLO**  
on pedestal with metal drawers







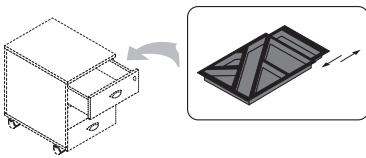

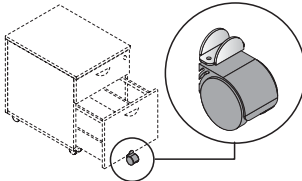

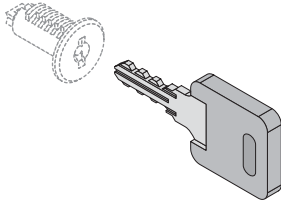
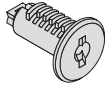
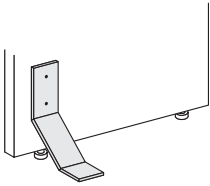

POS.	TIPO DI CARTELLA type of folder	INTERASSE CENTER DISTANCE (cm)
A	GRANDE EUROPA big Europe	cm 39
B	PICCOLA EUROPA little Europe	cm 33
C	GRANDE U.S.A. big U.S.A.	cm 38,5
D	PICCOLA U.S.A. little U.S.A.	cm 31
E	GRANDE CILE big Chile	cm 37,2



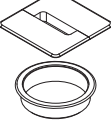
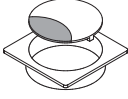

 = CON DOTAZIONE STANDARD ARCHIVIAZIONE EUROPEA  
= European filing by standard outfit

DESCRIZIONE description	L w	CODICE code	KG	M <sup>3</sup>	COLLI	PREZZO price	(*) CODICE FINITURA (*) finish code		
PORTA CANCELLERIA INTERNO PER CASSETTIERA internal stationery holder for drawers    L.32,5-45 x p.22 x H.2,5		175 186 (*)	1	0,004	1	€ 18,00	(*)		
								500	NERO

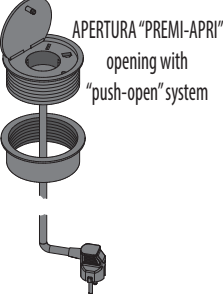
DESCRIZIONE description	L w	CODICE code	KG	M <sup>3</sup>	COLLI	PREZZO price	(*) CODICE FINITURA (*) finish code				
5a RUOTA OPZIONALE PER CASSETTIERA-CLASSIFICATORE fifth optional wheel for file-pedestal  		175 105 (*)	1	0,001	1	€ 13,00	(*)				
								000	ARGENTO silver	PIASTRINO plate	RUOTA wheels NERA black
								300	ARGENTO silver	PIASTRINO plate	RUOTA wheels GRIGIA grey

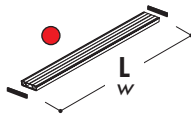
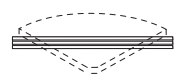
KIT CILINDRO SERRATURA PER CHIAVI UGUALI cylinder lock kit for keys alike								
DESCRIZIONE description	L w	CODICE code	KG	M <sup>3</sup>	COLLI	PREZZO price	(*) CODICE FINITURA (*) finish code	
CHIAVE PER ESTRAZIONE CILINDRO SERRATURA key for extraction cylinder lock 		171 058 (*)	0,1	0,001	1	€ 10,00		
CILINDRO SERRATURA ESTRAIBILE PER CHIAVI UGUALI + 2 CHIAVI PIEGHEVOLI extractable cylinder lock for keys alike + 2 folding keys   <b>ATTENZIONE! PER L'ESTRAZIONE DEL CILINDRO, OCCORRE SEMPRE UTILIZZARE LA CHIAVE ART.058</b> attention! for extraction of the cylinder, always use the key art.058		171 059 (*)	0,1	0,001	1	€ 9,00	(*)	
							999 ZINCATO zinc plated	
	<b>PER TUTTE LE ANTE LEGNO, VETRO, CASSETTIERE E MOBILI</b> for all wooden doors, glass doors, pedestals and cabinets							
STAFFE stirrups								
PIEDE STABILIZZATORE (OPTIONAL) stabilizer foot (optional) 		175 545 (*)	1	0,003	1	€ 22,00		
SET 4 STAFFE PER FISSAGGIO PANNELLI SOTTO PIANI SCRIVANIE (OPTIONAL) set of 4 brackets for fixing panels under desk tops (optional)   L.5 x H.5		175 546 (*)	1	0,001	1	€ 19,00	(*)	
							000 ARGENTO silver	



<b>PASSACAVI, FRESE PER FORATURA E PRESA AD INCASSO</b> <i>cablе-way, millers for holes and built-in socket</i>							
DESCRIZIONE <i>description</i>	L <i>w</i>	CODICE <i>code</i>	KG 	M <sup>3</sup> 	COLLI 	PREZZO <i>price</i>	(*) CODICE FINITURA <i>(*) finish code</i>
PASSACAVO Ø 60 mm <i>cablе-way Ø 60 mm-</i> 		175 791 (*)	1	0,001	1	€ 12,00	
							(*)
PUNTA AL WIDIA Ø 60 mm PER PASSACAVO <i>drill widia Ø 60 mm for cablе-way</i> 		175 792 (*)	1	0,001	1	€ 148,00	500 NERO <i>black</i>
PASSACAVO Ø 80 mm <i>cablе-way Ø 80 mm</i> 		175 787 (*)	0,6	0,001	1	€ 23,00	(*)
							450 BIANCO <i>white</i> 551 ANTRACITE <i>anthracite</i> 844 STONE GREY <i>stone grey</i>
PASSACAVO IN METALLO Ø 80 mm <i>metal cablе-way Ø 80 mm</i> 		175 788 (*)	0,6	0,001	1	€ 31,00	(*)
							000 CROMATO <i>chromed</i> 450 BIANCO <i>white</i> 500 NERO <i>black</i>
PASSACAVO Ø 80 mm <i>cablе-way Ø 80 mm</i> 		175 793 (*)	1	0,002	1	€ 15,00	(*)
							999 TRASPARENTE <i>transparent</i>
PUNTA AL WIDIA Ø 80 mm PER PASSACAVO <i>drill widia Ø 80mm for cablе-way</i> 		175 794 (*)	1	0,002	1	€ 166,00	(*)
							500 NERO <i>black</i>
PASSACAVO Ø 80 mm <i>cablе-way Ø 80 mm</i> 		175 795 (*)	1	0,002	1	€ 15,00	
PASSACAVO Ø 80 mm <i>cablе-way Ø 80 mm</i> 		175 392 (*)	1,5	0,002	1	€ 54,00	(*)
							000 CROMATO <i>chromed</i>
PRESA AD INCASSO Ø80MM (CON CAVO DI ALIMENTAZIONE MT. 3,00 E PRESA STANDARD SCHUKO) <i>built in socket Ø 80 mm</i> <i>(power cablе of w 3 lmt. and SCHUKO standard socket)</i>   APERTURA "PREMI-APRI" <i>opening with</i> <i>"push-open" system</i>  NON DISPONIBILE PER MERCATO U.S.A. <i>not available for US market</i>		175 111 (*)	1	0,008	1	€ 73,00	(*)
							500 NERO <i>black</i>
							1 PRESA STANDARD SCHUKO 1 KIT DATI RJ45 CAT.6 1 USB 1 SCHUKO standard socket 1 data kit RJ45 Cat.6 1 USB

CANALINE PER ELETTRIFICAZIONE									
channeled bar for desks									
DESCRIZIONE description	L w	L w	CODICE code	KG	M <sup>3</sup>	COLLI	PREZZO price	(*) CODICE FINITURA (*) finish code	
CANALINA ELETTRIFICAZIONE SOTTOPIANO PER SCRIVANIA <i>channeled bar for desk top</i>  									
			● PER SCRIVANIE L. for desks w						
	L79,6	L80	175 413 (*)	1	0,001	1	€ 19,00		
	L89,6	L90	175 428 (*)	1	0,001	1	€ 20,00		
	L119,6	L120	175 414 (*)	1	0,001	1	€ 23,00		
	L129,6	L130	175 429 (*)	1	0,001	1	€ 28,00		
	L139,6	L140	175 415 (*)	2	0,002	1	€ 29,00		
	L159,6	L160	175 416 (*)	2	0,003	1	€ 29,00		
L179,6	L180	175 417 (*)	3	0,004	1	€ 31,00			
(*)									
500 NERO black									
CANALINA ELETTRIFICAZIONE PER ANGOLO 90° <i>channeled bar for 90° segment</i>  			175 423 (*)	2	0,002	1	€ 21,00		
	(DA TAGLIARE A MISURA SECONDO IL MODELLO) (to be cut at measure according to the model)								
	L.123								
CANALINA PER SALITA SU FIANCO SCRIVANIA <i>channeled bar for final side-panels desk</i>  			175 418 (*)	1	0,001	1	€ 17,00		
	(DA TAGLIARE A MISURA SECONDO IL MODELLO) (to be cut at measure according to the model)								
	L.72,5								
VERTEBRA A 2 VIE <i>2 ways rising channel</i>  			175 424 (*)	1	0,006	1	€ 42,00		
	(*)								
	000 ARGENTO silver								
500 NERO black									
VERTEBRA "KUADRA" mm60x40 <i>"KUADRA" rising channel 2¼"x1½"</i>  		H.73	175 425 (*)	0,5	0,006	1	€ 59,00		
		H.110	175 426 (*)	0,5	0,006	1	€ 75,00		
	(*)								
	000 ARGENTO silver								
450 BIANCO white									

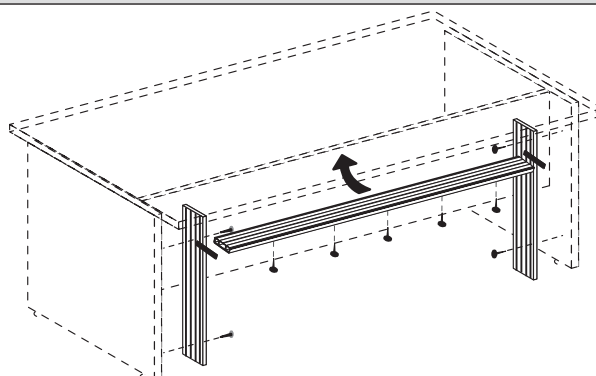
**SCHEMA DI MONTAGGIO CANALINE**  
assembling scheme of channeled bars



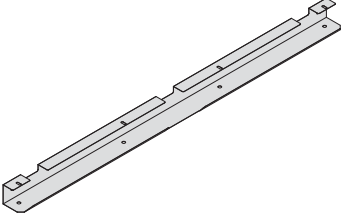
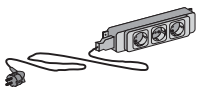
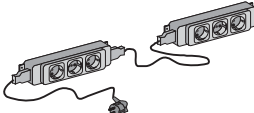

CANALI PORTA-CAVI E KIT PER ELETTRIFICAZIONE									
cable channels and electrification kit									
DESCRIZIONE description	L w	L w	CODICE code	KG	M <sup>3</sup>	COLLI	PREZZO price	(*) CODICE FINITURA (*) finish code	
CANALI PORTA-CAVI IN LAMIERA PER SCRIVANIE O PARETINE plate cable channels for desk or partition panels  	L. CANALE PORTA-CAVI width cable-channel	PER PARETINA L. for partition panel width							
	L48	L60	175 451 (*)	1,2	0,008	1	€ 18,00		
	L58	L70	175 452 (*)	1,2	0,008	1	€ 18,00		
	L68	L80	175 453 (*)	1,2	0,008	1	€ 19,00	(*)	
	L78	L90	175 454 (*)	1,3	0,014	1	€ 21,00	000	ARGENTO silver
	L88	L100	175 455 (*)	1,4	0,011	1	€ 22,00	450	BIANCO white
	L108	L120	175 456 (*)	1,5	0,014	1	€ 25,00	551	ANTRACITE anthracite
	L128	L140	175 457 (*)	1,6	0,021	1	€ 31,00	844	STONE GREY stone grey
	L148	L160	175 458 (*)	1,8	0,021	1	€ 34,00		
	L168	L180	175 459 (*)	2	0,021	1	€ 38,00		
KIT ELETTTRIF. SINGOLO CON PRESE SCHUKO E CAVO DI ALIMENTAZIONE DI MT. 2,00 single electrif. kit with SCHUKO sockets and power cable w 2 lmt.   <b>NON DISPONIBILE PER MERCATO U.S.A.</b> <i>not available for US market</i>			175 899 (*)	1	0,006	1	€ 86,00		
KIT ELETTTRIF. DOPPIO CON PRESE SCHUKO E CAVO DI ALIMENTAZIONE DI MT. 2,00 double electrif. kit with SCHUKO sockets and power cable w 2 lmt.   <b>NON DISPONIBILE PER MERCATO U.S.A.</b> <i>not available for US market</i>			175 900 (*)	1	0,006	1	€ 160,00	(*)	
								500	NERO black
KIT PROLUNGA DI MT. 2,00 CON PRESA ENTRATA/1 USCITA extension kit of w 2 lmt. with an input-and-out-put-plug   <b>NON DISPONIBILE PER MERCATO U.S.A.</b> <i>not available for US market</i>			175 901 (*)	0,5	0,002	1	€ 30,00		

### ESEMPIO DI UTILIZZO CANALI PORTA CAVI

Examples for using cable channels

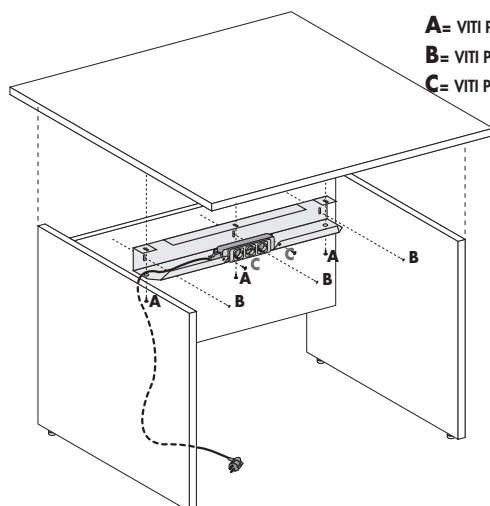







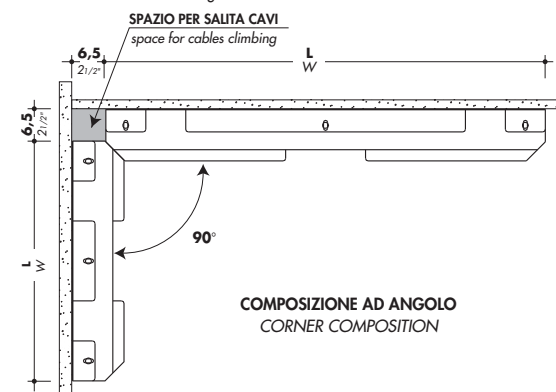

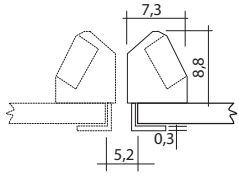

A= VITI PER FISSAGGIO SOTTO-PIANO / screws for fixing under-top

B= VITI PER FISSAGGIO SU SCHIENA O PARETINA / screws for fixing on back panel or partition wall

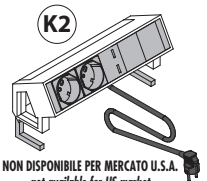
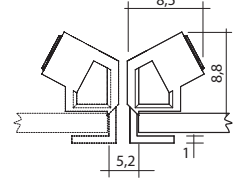
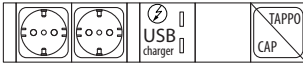
C= VITI PER FISSAGGIO KIT ELETTRIFICAZIONE / screws for fixing electrification kit

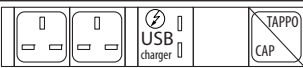
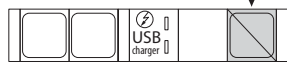

COMPOSIZIONE AD ANGOLO  
CORNER COMPOSITION

KIT ELETRIFICAZIONE tipo K1 (BACHMANN) electrification kit type K1 (by Bachmann)		BACHMANN					(*) CODICE FINITURA (*) finish code				
DESCRIZIONE description	L w	CODICE code	KG	M <sup>3</sup>	COLLI	PREZZO price					
<p>1 KIT ELETRIFICAZIONE ORIZZONTALE CON MORSETTO PER FISSAGGIO A SCRIVANIA (CON CAVO DI ALIMENTAZIONE MT. 2,00 E PRESE STANDARD) CON 1 MODULO PERSONALIZZABILE OPTIONAL 1 electrification kit with fixing clamp on desktop (power cable of w 2 lmt. and standard sockets) with 1 customizable module (OPTIONAL)</p>  <p><b>K1</b></p> <p>NON DISPONIBILE PER MERCATO U.S.A. not available for US market</p>  <p>L.28,1 x p.7,3 x H.8,8</p>		<b>175 117 (*)</b>	1,5	0,010	<b>2</b>	<b>€ 257,00</b>					
			<b>2 PRESE STANDARD ITALIA GERMANIA(SCHUKO)+2 CHARGER USB+1 TAPPO</b> 2 Italia/Germany standard sockets+ 2 charger USB+1 cap								
		<b>175 118 (*)</b>	1,5	0,010	<b>2</b>	<b>€ 243,00</b>					
			<b>2 PRESE STANDARD FRANCIA+2 CHARGER USB +1 TAPPO</b> 2 France standard sockets + 2 charger USB + 1 cap								
		<b>175 119 (*)</b>	1,5	0,010	<b>2</b>	<b>€ 270,00</b>					
			<b>2 PRESE STANDARD INGLESI+2 CHARGER USB +1 TAPPO</b> 2 BRITISH standard sockets + 2 charger USB +1 cap								
							(*)				
							<b>000</b>	ARGENTO	silver		
KIT ELETRIFICAZIONE tipo K2 (BACHMANN) electrification kit type K2 (by Bachmann)		BACHMANN					(*) CODICE FINITURA (*) finish code				
DESCRIZIONE description	L w	CODICE code	KG	M <sup>3</sup>	COLLI	PREZZO price					
<p>1 KIT ELETRIFICAZIONE ORIZZONTALE CON MORSETTO PER FISSAGGIO A SCRIVANIA (CON CAVO DI ALIMENTAZIONE MT. 2,00 E PRESE STANDARD) CON 1 MODULO PERSONALIZZABILE OPTIONAL 1 electrification kit with fixing clamp on desktop (power cable of w 2 lmt. and standard sockets) with 1 customizable module (OPTIONAL)</p>  <p><b>K2</b></p> <p>NON DISPONIBILE PER MERCATO U.S.A. not available for US market</p>  <p>L.28,1 x p.8,5 x H.8,8</p>		<b>175 120 (*)</b>	1,5	0,010	<b>2</b>	<b>€ 317,00</b>					
			<b>2 PRESE STANDARD ITALIA GERMANIA(SCHUKO)+2 CHARGER USB +1 TAPPO</b> 2 Italia/Germany standard sockets + 2 charger USB + 1 cap								
		<b>175 121 (*)</b>	1,5	0,010	<b>2</b>	<b>€ 285,00</b>					
			<b>2 PRESE STANDARD FRANCIA+2 CHARGER USB +1 TAPPO</b> 2 France standard sockets + 2 charger USB + 1 cap								
		<b>175 122 (*)</b>	1,5	0,010	<b>2</b>	<b>€ 343,00</b>					
			<b>2 PRESE STANDARD INGLESI+2 CHARGER USB +1 TAPPO</b> 2 BRITISH standard sockets + 2 charger USB +1 cap								
							(*)				
							<b>450</b>	BIANCO	white		
							<b>500</b>	NERO	black		
MODULI PERSONALIZZABILI (BACHMANN) customizable modules (by Bachmann)		BACHMANN					(*) CODICE FINITURA (*) finish code				
DESCRIZIONE description	L w	CODICE code	KG	M <sup>3</sup>	COLLI	PREZZO price					
<p>1 MODULO PERSONALIZZABILE 1 customizable module</p> <p><b>RIMUOVERE IL TAPPO IN DOTAZIONE E INSERIRE QUI IL MODULO</b> REMOVE THE CAP AND INSERT THE MODULE HERE</p>  <p>L.4,5 x H.4,5</p>		 <b>1 RJ45 CAT.6</b>	<b>175 123 (*)</b>	0,5	0,001	<b>1</b>	<b>€ 39,00</b>				
			<b>2 RJ45 CAT.6</b>	<b>175 124 (*)</b>	0,5	0,001	<b>1</b>	<b>€ 73,00</b>			
			<b>1 RJ45 CAT.6 1 HDMI</b>	<b>175 125 (*)</b>	0,5	0,001	<b>1</b>	<b>€ 73,00</b>			
								(*)			
							<b>500</b>	NERO	black		

# KIT ELETRIFICAZIONE tipo Y3

electrification kit type Y3

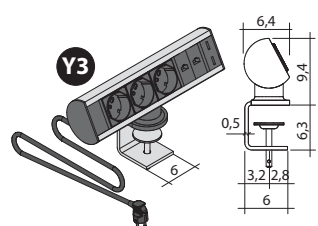
DESCRIZIONE description	CODICE code	KG	M <sup>3</sup>	COLLI	PREZZO price	(*) CODICE FINITURA (* finish code)
<p>KIT ELETRIFICAZIONE ORIZZONTALE CON MORSETTO PER FISSAGGIO A SCRIVANIA (CON CAVO DI ALIMENTAZIONE MT. 3,00 E PRESE STANDARD) electrification kit with fixing clamp on desktop (power cable of - and standard sockets)</p>  <p><b>NON DISPONIBILE PER MERCATO U.S.A.</b> not available for US market</p> <p>L.26 x p.6,4 x H.9,4+6,3</p>	175 106 (*)	2	0,010	1	€ 144,00	
	<p>3 PRESE STANDARD ITALIA/GERMANIA (SCHUKO) 2 KIT DATI RJ45 CAT.6 + 2 USB 3 Italia/Germany standard sockets 2 data kit RJ45 Cat.6 + 2 USB</p>					
	<p>(*)</p> <p>000 ARGENTO silver</p>					
	175 107 (*)	2	0,010	1	€ 144,00	
<p>3 PRESE STANDARD FRANCIA 2 KIT DATI RJ45 CAT.6 + 2 USB 3 France standard sockets 2 data kit RJ45 Cat.6 + 2 USB</p>						

## SCHEMA DI UTILIZZO KIT ELETRIFICAZIONE

scheme of use electrification kit

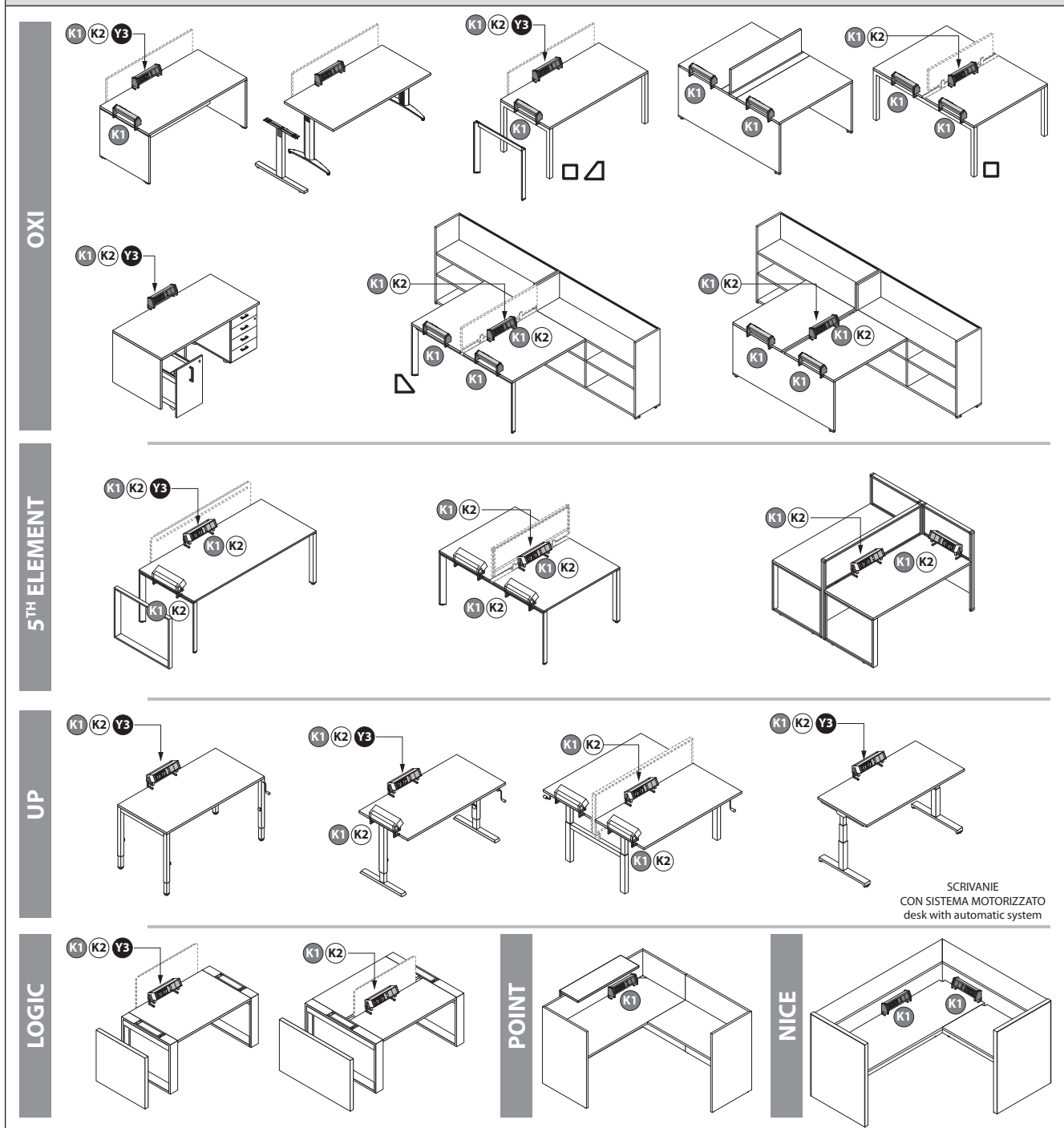

**INDICE DEI CODICI**  
*codes index*

\* = INDICARE IL CODICE FINITURA  
 = complete with finish code

INDICE DEI CODICI / codes index  
 Mod. ACCESSORI OYO

CODICE code	DESCRIZIONE description	PAG. page	PREZZO price
175 016 *	4 ELEMENTI PER SOVRAPPOSIZIONE DI VASCHETTE ART.353 set of 4 elements for superimposition of paper-holder art.353	5	€ 19,00
175 050 *	SUPPORTO PER PC-TOWER INDIPENDENTE CON RUOTE separate trolley with wheels for vertical PC-tower	8	€ 83,00
175 081 *	SUPPORTO PER PC-TOWER SOTTOPIANO REGOLABILE undertop support adjustable for PC-tower	8	€ 88,00
175 082 *	PORTA-TASTIERA ESTRAIBILE L.56 REGOLABILE IN ALTEZZA + PORTA-MOUSE pull-out keyboard tray height adjustable with mouse-holder shelf	7	€ 61,00
175 096 *	REGGICARTELLE ESTRAIBILE L.90 pull-out folders support w 90 cms	10	€ 139,00
175 097 *	REGGICARTELLE ESTRAIBILE L.45 pull-out folders support w 45 cms	10	€ 118,00
175 098 *	REGGICARTELLE FISSO L.90 fixed folders support w 90 cms	10	€ 42,00
175 099 *	REGGICARTELLE FISSO L.45 fixed folders support w 45 cms	10	€ 30,00
175 105 *	5° OPZIONALE NERA PER CASSETTIERA CLASSIFICATORE fifth optional black wheel for file-pedestal	11	€ 13,00
175 106 *	3 PRESE STANDARD ITALIA/GERMANIA SCHUKO+ 2 RJ45 CAT.6 + 2 USB 3 Italy/Germany SCHUKO standard sockets+2 RJ45 CAT. 6 + 2 USB	Y3	€ 144,00
175 107 *	3 PRESE STANDARD FRANCIA+ 2 RJ45 CAT. 6 + 2 USB 3 France standard sockets+2 RJ45 CAT. 6 + 2 USB	Y3	€ 144,00
175 111 *	PRESA AD INCASSO Ø 80MM CON 1 PRESA SCHUKO + 1 RJ45 CAT. 6 + 1 USB built in socket Ø 80 mm with 1 SCHUKO socket + 1 data kit RJ45 CAT. 6 + 1 USB	NERO black	€ 73,00
175 117 *	2 PRESE STANDARD ITALIA/GERMANIA SCHUKO+ 2 CHARGER USB + 1 TAPPO 2 Italy/Germany SCHUKO standard sockets+2 charger USB + 1 cap	K1	€ 257,00
175 118 *	2 PRESE STANDARD FRANCIA+ 2 CHARGER USB + 1 TAPPO 2 FRANCE standard sockets+2 charger USB + 1 cap	K1	€ 243,00
175 119 *	2 PRESE STANDARD INGLESI+ 2 CHARGER USB + 1 TAPPO 2 BRITISH standard sockets+2 charger USB + 1 cap	K1	€ 270,00
175 120 *	2 PRESE STANDARD ITALIA/GERMANIA SCHUKO+ 2 CHARGER USB + 1 TAPPO 2 Italy/Germany SCHUKO standard sockets+2 charger USB + 1 cap	K2	€ 317,00
175 121 *	2 PRESE STANDARD FRANCIA+ 2 CHARGER USB + 1 TAPPO 2 FRANCE standard sockets+2 charger USB + 1 cap	K2	€ 285,00
175 122 *	2 PRESE STANDARD INGLESI+ 2 CHARGER USB + 1 TAPPO 2 BRITISH standard sockets+2 charger USB + 1 cap	K2	€ 343,00
175 123 *	1 RJ45 CAT.6	16	€ 39,00
175 124 *	2 RJ45 CAT.6	16	€ 73,00
175 125 *	1 RJ45 CAT.6 + 1 HDMI	16	€ 73,00
175 131 *	RIPIANO IN METALLO PER MOBILI L.90 metal shelf for cabinets w 90 cms	10	€ 46,00
175 132 *	RIPIANO IN METALLO PER MOBILI L.45 metal shelf for cabinets w 45 cms	10	€ 35,00
175 137 *	ADATTATORI PER CLASSIFICATORI (PER VARI FORMATI DI CARTELLE) L.33 fits for file-drawer (for different folde sizes) w 33 cms	11	€ 11,00
175 161 *	POGGIA-PIEDI foot-rest	8	€ 60,00
175 172 *	PORTA-ABITI 2 POSTI (2 hooks) clothes hanger	9	€ 66,00
175 173 *	PORTA-ABITI 3 POSTI (3 hooks) clothes hanger	9	€ 83,00
175 180 *	CESTINO wastebasket	8	€ 19,00
175 181 *	ACCESSORI SCRIVANIA desk accessories	6	€ 51,00
175 182 *	PORTA-ABITI A STELO clothes-tree	9	€ 151,00
175 183 *	PORTA-ABITI A STELO clothes-tree	9	€ 110,00
175 186 *	PORTA CANCELLERIA INTERNO PER CASSETTIERE internal stationery holder for drawers	11	€ 18,00
175 188 *	CASSETTO IN PLASTICA PORTA-CANCELLERIA SOTTOPIANO stationery plastic drawer under desk top	7	€ 86,00
175 217 *	SUPPORTO PER PC-TOWER INDIPENDENTE CON RUOTE separate trolley with wheels for vertical PC-tower	8	€ 62,00
175 222 *	PORTA-TASTIERA ESTRAIBILE L.58 REGOLABILE IN ALTEZZA pull-out keyboard tray height adjustable w 58 cms	7	€ 102,00
175 349 *	BASE PER LAMPADA base for lamp	6	€ 55,00
175 351 *	PORTA-PENNE pen-holder	5	€ 30,00
175 352 *	PORTA-OGGETTI object-holder	5	€ 54,00
175 353 *	KIT 2 PORTA-CARTA L.35 set of 2 paper-holder w 35 cms	5	€ 69,00
175 361 *	MORSETTO PER ANCORAGGIO LAMPADA A PIANI DI LAVORO clamp for fixing lamp to worktop	6	€ 38,00
175 362 *	BRACCIO SNODATO PORTA-VIDEO CON MORSETTO PER ANCORAGGIO A PIANI DI LAVORO articulated rotating video stand arm + clamp for fixing to worktops	6	€ 263,00
175 392 *	PASSACAVO Ø 80mm CROMATO charomded cable way Ø 80mm	CROMATO chromed	€ 54,00
175 413 *	CANALINA ELETTR. SOTTOPIANO PER SCRIVANIA L.80 channeled bar for under desk top w 80 cms	14	€ 19,00
175 414 *	CANALINA ELETTR. SOTTOPIANO PER SCRIVANIA L.120 channeled bar for under desk top w 120 cms	14	€ 23,00
175 415 *	CANALINA ELETTR. SOTTOPIANO PER SCRIVANIA L.140 channeled bar for under desk top w 140 cms	14	€ 29,00

\* = INDICARE IL CODICE FINITURA  
= complete with finish code

INDICE DEI CODICI / codes index  
Mod. ACCESSORI OYO

CODICE code	DESCRIZIONE description	PAG. page	PREZZO price
175 416 *	CANALINA ELETTR. SOTTOPIANO PER SCRIVANIA L.160 channeled bar for under desk top w 160 cms	14	€ 29,00
175 417 *	CANALINA ELETTR. SOTTOPIANO PER SCRIVANIA L.180 channeled bar for under desk top w 180 cms	14	€ 31,00
175 418 *	CANALINA ELETTR. PER SALITA SU FIANCO SCRIVANIA channeled bar for final side panels desk	14	€ 17,00
175 423 *	CANALINA ELETTR. SOTTOPIANO PER ANGOLO 90° channeled bar for under 90° segment	14	€ 21,00
175 424 *	VERTEBRA A 2 VIE PER SALITA 2 ways rising channels	14	€ 42,00
175 425 *	VERTEBRA QUADRATA 5x5XH.73 CM square rising channel 5x5xh.73 cms	14	€ 59,00
175 426 *	VERTEBRA QUADRATA 5x5XH.110 CM square rising channel 5x5xh.110 cms	14	€ 75,00
175 428 *	CANALINA ELETTR. SOTTOPIANO PER SCRIVANIA L.90 channeled bar for under desk top w 90 cms	14	€ 20,00
175 429 *	CANALINA ELETTR. SOTTOPIANO PER SCRIVANIA L.130 channeled bar for under desk top w 130 cms	14	€ 28,00
175 451 *	CANALE PORTA-CAVI IN LAMIERA L.48 plate cable channel w 48 cms	15	€ 18,00
175 452 *	CANALE PORTA-CAVI IN LAMIERA L.58 plate cable channel w 58 cms	15	€ 18,00
175 453 *	CANALE PORTA-CAVI IN LAMIERA L.68 plate cable channel w 68 cms	15	€ 19,00
175 454 *	CANALE PORTA-CAVI IN LAMIERA L.78 plate cable channel w 78 cms	15	€ 21,00
175 455 *	CANALE PORTA-CAVI IN LAMIERA L.88 plate cable channel w 88 cms	15	€ 22,00
175 456 *	CANALE PORTA-CAVI IN LAMIERA L.108 plate cable channel w 108 cms	15	€ 25,00
175 457 *	CANALE PORTA-CAVI IN LAMIERA L.128 plate cable channel w 128 cms	15	€ 31,00
175 458 *	CANALE PORTA-CAVI IN LAMIERA L.148 plate cable channel w 148 cms	15	€ 34,00
175 459 *	CANALE PORTA-CAVI IN LAMIERA L.168 plate cable channel w 168 cms	15	€ 38,00
175 483 *	PANNELLO FRONTALE L.120 front panel w 120 cms	MELAMINICO melamine	5 € 60,00
175 484 *	PANNELLO FRONTALE L.140 front panel w 140 cms	MELAMINICO melamine	5 € 65,00
175 485 *	PANNELLO FRONTALE L.160 front panel w 160 cms	MELAMINICO melamine	5 € 70,00
175 486 *	PANNELLO FRONTALE L.180 front panel w 180 cms	MELAMINICO melamine	5 € 75,00
175 493 *	PANNELLO FRONTALE L.120 front panel w 120 cms	TESSUTO fabric	5 € 189,00
175 494 *	PANNELLO FRONTALE L.140 front panel w 140 cms	TESSUTO fabric	5 € 200,00
175 495 *	PANNELLO FRONTALE L.160 front panel w 160 cms	TESSUTO fabric	5 € 216,00
175 496 *	PANNELLO FRONTALE L.180 front panel w 180 cms	TESSUTO fabric	5 € 232,00
175 545 *	PIEDE STABILIZZATORE stabilizer foot		12 € 22,00
175 546 *	SET 4 STAFFE PER FISSAGGIO PANNELLI A SCRIVANIE (OPTIONAL) set of 4 brackets for fixing panels under desk tops (optional)		12 € 19,00
175 753 *	LAMPADA A LED led lamp		6 € 387,00
175 787 *	PASSACAVO Ø 80mm cable way Ø 80mm		13 € 23,00
175 788 *	PASSACAVO IN METALLO Ø 80mm metal cable way Ø 80mm		13 € 31,00
175 791 *	PASSACAVO Ø 60mm cable way Ø 60mm		13 € 12,00
175 792 *	PUNTA AL WIDIA Ø 60mm drill widia for cable way Ø 60mm		13 € 148,00
175 793 *	PASSACAVO Ø 80mm cable way Ø 80mm	TRASPARENTE transparent	13 € 15,00
175 794 *	PUNTA AL WIDIA Ø 80mm drill widia for cable way Ø 80mm		13 € 166,00
175 795 *	PASSACAVO Ø 80mm cable way Ø 80mm	NERO black	13 € 15,00
175 899 *	KIT ELETTRIF. SINGOLO CON PRESE SCHUKO E CAVO DI ALIMENTAZIONE DI MT 2,00 single electrification kit with SCHUKO sockets and power cable of w 200 cms		15 € 86,00
175 900 *	KIT ELETTRIF. DOPPIO CON PRESE SCHUKO E CAVO DI ALIMENTAZIONE DI MT 2,00 double electrification kit with SCHUKO sockets and power cable of w 200 cms		15 € 160,00
175 901 *	KIT PROLUNGA DI MT 2,00 CON 1 PRESA ENTRATA / 1 USCITA extension kit of w 200 cms with an input-and-out-put-plug		15 € 30,00
<b>KIT FERRAMENTA / fittings kit</b>			
171 058 *	CHIAVE PER STRAZIONE CILINDRO SERRATURA key for extraction cylinder lock		12 € 10,00
171 059 *	CILINDRO SERRATURA ESTRAIBILE PER CHIAVI UGUALI extractable cylinder lock for keys alike		12 € 9,00





**LISTINO** 2018  
PRICE LIST

## **CONDIZIONI GENERALI DI VENDITA**

General sales conditions

---

# CONDIZIONI GENERALI DI VENDITA

## *general sales conditions*

---

**1- Il presente listino annulla e sostituisce tutti i precedenti.**

*The present price-list replaces the previous ones.*

**2- La Las Mobili s.r.l. si riserva il diritto di apportare modifiche tecniche, dimensionali ed estetiche alla propria produzione.**

*Las Mobili s.r.l. reserves the right to make technical, dimensional and aesthetic changes in production.*

**3- La proposta d'ordine è subordinata all'accettazione della LAS MOBILI srl; i termini di consegna, se diversi da quelli richiesti nella proposta d'ordine, sono indicati nell'accettazione e sono impegnativi, salvo causa di forza maggiore.**

*An order proposal is subordinate to LAS MOBILI's acceptance; whenever different from those requested in order proposal, delivery terms are pointed out in acceptance and they are binding save uncontrollable events.*

**4- L'imballo: standard in cartoni è gratis. Gli imballi particolari preventivamente richiesti verranno fatturati al costo.**

*Packing: it is free of charge in standard cardboard boxes. Any particular packing requested before will be invoiced at its cost.*

**5- La merce venduta franco fabbrica viaggia a rischio del committente; eventuali danni imputabili al trasporto dovranno essere contestati al trasportatore e portati a conoscenza della LAS MOBILI srl con indicazione nel d.d.t.**

*Goods are sold ex-works and travel at buyer's risk; possible damage must be claimed at the forwarder and the fact must be advised to LAS MOBILI by a delivery document with an adequate note and signature on it.*

**6\* - Resa: Franco destino (sede cliente) per ordini di importo netto superiore a € 500,00: sugli ordini inferiori a detto importo, con riserva di consegna, saranno addebitate le spese di trasporto come da tariffe applicateci da nostro vettore.**

*Transport: carriage paid for orders amounting to more than € 500,00 net. in case of orders for less than this amount, with reserve of delivery, carriage will be charged as from our carrier's rates.*

**7- Reclami: per difetti di fabbricazione devono essere comunicati per iscritto entro 8gg. dal ricevimento della merce.**

*Complaints: any defects in production must be notified in writing within 8 days of receipt of the goods.*

**8- Il rivenditore è tenuto a consegnare la scheda prodotto, disponibile sul sito [www.las.it](http://www.las.it), ai propri clienti in ottemperanza al DLGS 6 Settembre 2005 n°206.**

*The retailer is obliged to give a product scheme, available on web site [www.las.it](http://www.las.it), to his customers as per the law DLGS 6 September 2005 no 206.*

**9- I prezzi sono IVA esclusa e validi fino a sostituzione del presente listino.**

*Prices do not include VAT and are valid until the present price list has been replaced.*

**10- Le presenti condizioni sono dichiarate accettate con l'ordine.**

*The present conditions are declared accepted with the order.*

**11- Condizioni Particolari: eventuali deroghe alle condizioni generali contrattuali qui convenute dovranno risultare in forma scritta.**

*Particular conditions: any exceptions to these general contractual conditions must appear in writing.*

**12- Foro competente: per ogni controversia è esclusivamente competente il Foro di Teramo.**

*Competent forum: for any disputes only the forum of Teramo is competent.*

**La Direzione Commerciale**

*The commercial management*



# GARANZIA

## warranty card

### Garanzia LAS MOBILI

Tutti i mobili LAS sono garantiti all'acquirente originale al momento dell'acquisto per un periodo di 5 (cinque) anni di "servizio a turno unico", a partire da allora, con le eccezioni sotto riportate.

Parti esposte quali:

Superfici verniciate	garanzia 3 (tre) anni
Piani di lavoro rivestiti in melaminico	garanzia 3 (tre) anni
Piani di lavoro rivestiti con foglie termoformabili (3d-foil)	garanzia 3 (tre) anni
Speciali non-standard	garanzia 1 (un) anno

Apparati elettrici quali: prese, spine, cavi di alimentazione, connettori, pulsantiere e motorizzazioni in genere

garanzia 2 (due) anni

La LAS MOBILI garantisce all'acquirente originale che il mobile e tutte le sue parti e componenti sono senza difetti nel materiale e nella lavorazione. "Difetti" in questa garanzia indica qualsiasi imperfezione che compromette l'utilizzo del prodotto.

La garanzia della Las Mobili è espressamente limitata alla sostituzione di parti e componenti di mobili.

La garanzia è valida per normali condizioni d'uso. I mobili LAS non possono essere utilizzati all'aperto né possono essere messi a contatto con fonti di calore ed umidità. Le parti in vetro devono essere maneggiate con cautela e gli sportelli e cassetti devono essere riportati allo stato di chiusura subito dopo l'uso.

La garanzia non copre:

- 1) difetti causati da un assemblaggio o smontaggio improprio;
- 2) difetti venuti fuori dopo l'acquisto dovuti a modifiche apportate al prodotto o sue parti, danni intenzionali, incidenti, uso errato, abuso, negligenza, esposizione agli elementi;
- 3) costi di lavoro e montaggio, difetti causati dal trasporto;
- 4) l'uniformità del colore, venatura o tessitura dei materiali di copertura ad eccezione degli standard commercialmente accettabili.

Il Concessionario provvederà a predisporre clausole di garanzia da consegnare all'acquirente finale.

Egli potrà ampliare le garanzie offerte dal Fabbricante, ma tutte le garanzie aggiuntive saranno a carico del Concessionario stesso.

Nel certificato di garanzia il Concessionario dovrà prevedere, fra l'altro, le modalità mediante le quali l'utente finale dovrà attivare l'intervento in garanzia.

Il Concessionario effettuerà l'intervento in garanzia presso l'utente finale, anche se a carico di LAS, che provvederà al rimborso ovvero ad inviare al Concessionari le parti da sostituire (se i difetti sono coperti dalla garanzia di LAS).

Il certificato di garanzia predisposto dal Concessionario per gli utenti finali impegna LAS nei limiti del prezzo di acquisto corrisposto dal Concessionario.

Il rispetto delle leggi vigenti nel Territorio, per quanto concerne la compilazione del certificato di garanzia, sono a cura e carico del Concessionario.

### LAS MOBILI Warranty Card

The original buyer of LAS furniture units is covered by a 5 (five) year "single-shift service" warranty starting on the day of purchase, with the following exceptions.

Exposed parts such as:

Painted surfaces	warranty 3 (three) years
Melamine-faced worktops	warranty 3 (three) years
Worktops faced with thermoformed sheets	warranty 3 (three) years
Special non-standard	warranty 1 (one) year

Electrical Devices such as: sockets, plugs, power cables, connectors, control panels and control gears in general

warranty two (2) years

LAS MOBILI guarantees to the original buyer that the furniture unit and all its parts and components are devoid of material and manufacturing faults. The word "faults" in the warranty refers to any imperfections affecting product use.

The Las Mobili warranty is expressly restricted to replacement of furniture parts and components. The warranty covers normal conditions of use. LAS units cannot be used out of doors nor placed in contact with heat sources and damp. Glass parts must be handled with care and the doors and drawers must always be closed immediately after use.

The warranty does not cover:

- 1) faults caused by incorrect assembly or dismantling;
- 2) faults occurring after purchase caused by changes made to the product or its parts, intentional damage, accidents, wrong use, abuse, negligence, exposure to elements;
- 3) work and assembly costs, faults caused by transport;
- 4) colour uniformity, grains or patterns of facing material, except for commercially acceptable standards.

The Dealer will provide warranty clauses to be given to the end buyer.

He shall be entitled to extend the warranties offered by the Manufacturer, but all the additional warranties shall be the responsibility of the Dealer.

In the warranty certificate, the Dealer must also indicate the procedures by means of which the end user must request jobs under warranty.

The Dealer shall carry out jobs under warranty on the premises of the end user, even though to the charge of LAS, which shall make refund, meaning it shall send the parts to be replaced to the Dealer (if the faults are covered by LAS warranty).

The warranty certificate prepared by the Dealer for the end users shall commit LAS within the limits of the price paid by the Dealer.

The Dealer shall undertake and shall be responsible for observing the laws applicable in the Area as regards the drawing up of the warranty certificate.

STAMPA GENNAIO 2018  
Printed JANUARY 2018



**LAS MOBILI s.r.l.**  
Società Unipersonale

Via dell'Industria, n°81  
64018 Tortoreto (Te) Italy  
Tel. +39 0861 7831  
Fax +39 0861 786851  
[www.las.it](http://www.las.it)  
e-mail: [las@las.it](mailto:las@las.it)



DESIGN: CENTRO STUDI E RICERCHE LAS MOBILI



Soggetto sottoposto all'attività di direzione e coordinamento della società **Las Holding s.r.l.** iscritto al registro delle imprese di Teramo Nr. 00195430673  
Subject submitted to the direction and coordination of Las Holding Ltd, registered at the register of companies of Teramo Nr. 00195430673



**Las Mobili s.r.l**

Via dell'Industria, n°81  
64018 Tortoreto (TE) - Italy  
T. +39. 0861 7831  
F. +39. 0861 786851  
[las@las.it](mailto:las@las.it) - [www.las.it](http://www.las.it)